

DECORATIVE
& OUTDOOR
2024
ANNUAL
LIGHTING
GUIDE

SPECTACULAR
MOMENTS

In the realm of spatial design, illumination assumes a pivotal role. Each Maytoni luminaire is distinctive and chosen to complement your design narrative.

It speaks volumes, allowing you to create spectacular moments.

We want to carry you on a luminary journey and have compiled our latest Maytoni Lighting Guide 2024 to help you achieve your lighting aspirations.

Discover for yourself Maytoni

1 Technical



Track systems

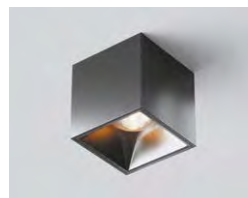

Downlights



Ceiling



Wall



Pendant

2 Decorative



Ceiling



Pendant



Wall



Table



Floor



Backlight

3 Outdoor



Garden and parks



Landscape



Architectural



Stairs, steps and paths



Pendant and ceiling

Maytoni international design awards

Internationale Design-Auszeichnungen Maytoni



archiproducts
AWARDS
WINNER

ADD
AWARDS



Index

8 **LUMINAIRES BY TYPE**

40 **STYLE INDEX**

50 **PRACTICAL LIGHTING
DESIGN TIPS**

64 **LUMINAIRES BY
COLLECTIONS**

MODERN

64 Glass
206 Composition
216 Crystal
244 Metal
282 Minimal
368 Universal Base
370 Fabric
380 Nature

CLASSIC

402	Crystal
418	Glass
422	Metal
424	Fabric
444	Backlight

458	PRACTICAL LIGHTING DESIGN TIPS
-----	-------------------------------------------

472	LUMINAIRES BY COLLECTIONS
-----	--------------------------------------

472	Architectural Lighting
490	Modern Lighting
616	Lighting for walls, steps and paths
632	Classic Lighting

638	ALPHABETICAL INDEX
-----	---------------------------

646	EXPLICATION
-----	--------------------

Ceiling

BALBO
MOD112 90



BOLLA
MOD133 94



BREEZE
MOD281 96



DALLAS
MOD545 106



DROP
MOD273 118



ERICH
MOD221 124



GILBERT
T532 142



GLASSY
MOD270 146



NOSTALGIA
MOD048 170



REELS
MOD268 178



TESSARA
MOD081 197



DUNE
DIA005 220



FACET
MOD094 222



FRAME
MOD174 226



IMAGINARY
MOD190

264

**ANILLO**
MOD315

298

**RIDA**
MOD015

330

**RADIANCE**
MOD278

344

**PLONS**
MOD283

343

**LINE**
MOD015

358

**RIM**
MOD058

361

**BERGAMO**
MOD613

370

**BASFOR**
DIA100

402

**BROCHE**
DIA902

405

**CASCADE**
DIA522

406

**KAROLINA**
DIA120

410

**OTTILIA**
DIA700

412

**PALACE**
DIA890

414

**COMBINARE**
C232

418

**PASCAL**
C908

420



ZEIL
H356 421



MESSINA
H233 434



VENERA
H260 436



Chandelier

MEMORY
MOD177 68



ARCO
MOD223 72



ASTER
MOD007 74



BALANCE
MOD317 88



BALBO
MOD112 90



AURA
MOD016 92



BOLLA
MOD133 94



BREEZE
MOD281 96



COLLINE
MOD083 102



DALLAS
MOD545 104



ERICH
MOD221 125



FORTANO
MOD089 132



JACKSON
T546 153



AMULET
MOD555 159



MARBLE
MOD187 161



MOOD
MOD172 164



NOSTALGIA
MOD048 170



RENDEZ-VOUS
MOD109 180



RING
MOD013 184

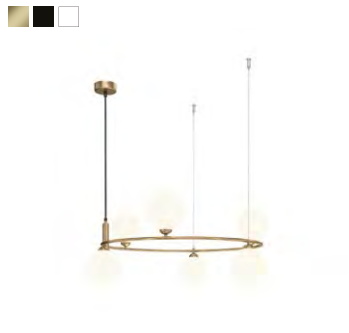

TROPIC
MOD164 198



VENTURA
MOD012 200



VISION
MOD411 204



FLARE
DIA200 224



FRAME
MOD174 226



GELID
MOD184 228



HAIL
MOD097 230



KRONE
P097 232



PUNTES
MOD043 238



REVERO
MOD085 240



WONDERLAND
MOD313 242



RECINTO
MOD080 243



BOWI
H009 246



GIRO
MOD095 256



GOLDEN CAGE
MOD216 262



MOLLIS
MOD126 266



VESPER
MOD108 276



HALO
MOD244 289



CURVE
MOD242 296



AXIS
MOD106 300



FAD
MOD070 310



GLINT
MOD072 314



SATURNO
MOD415 332



TAU
MOD146 340



RADIANCE
MOD278 344



LINE
MOD054 358



RIM
MOD058 364



SATELLITE
MOD102 367



IMPRESSIVE
MOD151 376



TALENTO
DIA008 380



MARMO
MOD099 390



BELLA
DIA750 404



GRACE
RC247 408



SEVILLA
DIA004 416



PERLA
ARM337 422



ALICANTE
MOD014 424



ANNA
H007 426



BRIONIA
ARM172 429



GRACE
ARM247 430



MESSINA
H233 434



VENERA
H260 436



VITTORIA
H004 438



ZARAGOZA
H001 440



Horizontal pendant

ASTER
MOD007 74



BREEZE
MOD281 97



COCTAIL TIME
MOD325 98



DALLAS
MOD547 104



ERICH
MOD221 124



COSMO
MOD210 138



AMULET
MOD555 158

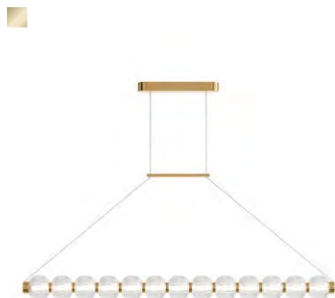

NOSTALGIA
MOD048 172



MIRACLE
MOD207 190



VISION
MOD411 204



CEREZO
MOD201 216



DUNE
DIA005 220



KRONE
P097 234



HALO
MOD246 292



CURVE
MOD243 296



MOTION
MOD276 316



NODE
MOD165 318



ORIGAMI
MOD163 324

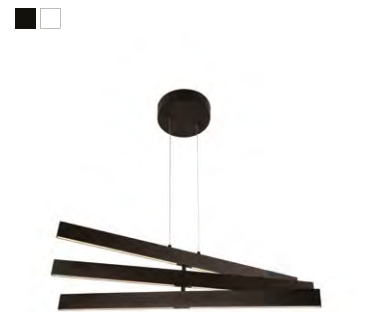

SKYLINE
MOD179 334

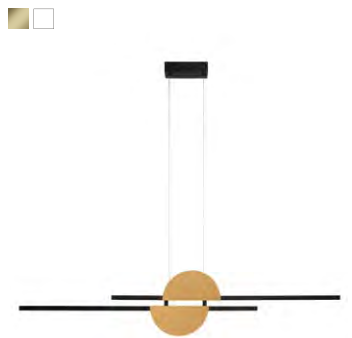

SUPERSYMMETRY
P096 338



TAU
MOD166 340



PETRA
MOD250 392



TOILS
DIA600 417



Vertical pendant

COCTAIL TIME
MOD325

98



DALLAS
MOD545

108



AMULET
MOD555

156



NOSTALGIA
MOD048

170



MIRACLE
MOD207

190



FAD
MOD070

266



NODE
MOD165

318



PESO
P080

320



Pendant

BANGKOK
MOD185

64



KYOTO
MOD178

66



MEMORY
MOD177

68



ANTIC
MOD302

70



BASIC FORM
MOD521

78



AURA
MOD016

92



COMETA
MOD056

93



COCTAIL TIME
MOD325

98



COLLAR
P069

100



THE SIXTH SENSE
Z020

114



DROP
MOD273

118



DUALITY
MOD271

120



DYNAMICS
MOD326

122



ERICH
MOD221

126



FERMI
P140

128



EUSTOMA
MOD238

130



FLUSSO
P095

131



SPLASH
MOD282

140



GIOIA
P011 144



TONE
P001 148



IRVING
T163 150



LIGERO
MOD061 152



LUNARE
MOD327 160



MAYA
P091 162



MOOD
MOD172 164



ORDO
MOD272 174



REBEL
MOD322 176



NEBULA
MOD182 179



RING
MOD013 182



FROZEN
MOD254 188



ROS
MOD227 192



SINTESI
P090 194



TELFORD
P362 196



VERTICALE
MOD308 202



CEREZO
MOD201

216



COIL
MOD124

218



BASIC COLORS
MOD167

244



EL
MOD041

250



ENIGMA
MOD150

252



GERHARD
MOD189

254



GIRO
MOD095

256



PALETTE
MOD303

257



GOLDEN CAGE
MOD216

262



IMAGINARY
MOD190

264



MOLLIS
MOD126

266



PLEC
P364

272



SONATA
MOD410

274



LANTERN
MOD029

279



AMBIENCE
MOD280

282



HALO
MOD246

290



CASCADE
MOD132 302



PRO BASE
MOD159 350



PRO EXTRA
MOD160 352



PRO SHADE
MOD157 354



PRO FOCUS
MOD161 356



REFLEX
MOD154 378



BICONES
P359 384



BRONI
T451 386



CANE
MOD204 386



ROOTS
MOD197 394



GRACE
ARM247 431



Composition of pendant

BASIC FORM
MOD521 76



DROP
MOD273 118



FERMI
P140 128



FROZEN
MOD254 118



LIGHT STICK
MOD236 284



CASCADE
MOD132 302



REFLEX
MOD154 376



Wall lamp

MEMORY
MOD177 68



ANTIC
MOD302 70



ARCO
MOD223 72



ASTER
MOD007 74



BASIC FORM
MOD521 76



BAO
MOD419 84



AVANT-GARDE
MOD324

86



AURA
MOD016

92



COCTAIL TIME
MOD325

98



COLLINE
MOD083

102



DALLAS
MOD545

108



KAZIMIR
MOD175

112



TOUCH
MOD285

116



ERICH
MOD221

126



FORTANO
MOD089

132



GILBERT
T532

142



IRVING
T163

150



LIGERO
MOD061

152



AMULET
MOD555

159



LUNARE
MOD327

160



MARBLE
MOD187

161



MAYA
P091

162



MOOD
MOD172 164



NOSTALGIA
MOD048 170



RENDEZ-VOUS
MOD109 180



PATTERN
MOD267 185



MIRACLE
MOD207 190



SINTESI
P090 194



TROPIC
MOD164 198



VENTURA
MOD012 200



VERTICALE
MOD308 202



VISION
MOD411 204



MABELL
MOD306 206



MARE
MOD305 208



PRIMA
Z034 210



JUPITER
MOD320 212



ROTTA
MOD413 214



COIL
MOD124 218

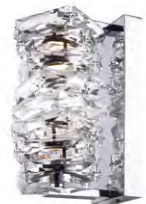

DUNE
DIA005 220



FACET
MOD094 222



FLARE
DIA200 224



FRAME
MOD174 226



GELID
MOD184 228



HAIL
MOD097 230



PUNTES
MOD043 236



REVERO
MOD085 240



DYNAMICS
MOD326 248



GIRO
MOD095 256



JACK-STONE
MOD314 258



LOVETANN
MOD082 260



GOLDEN CAGE
MOD216 262



MOLLIS
MOD126 267



NOTTA
MOD417 268



PIXEL
MOD421 270



SONATA
MOD410 274



VESPER
MOD108 276



LIGHT STICK
MOD237 284



HALO
MOD005 288



HALO
MOD248 290



AXIS
MOD106 300



FAD
MOD070 308



NUANCE
MOD180 322



RENAISSANCE
MOD256 328



SKYLINE
MOD179 334

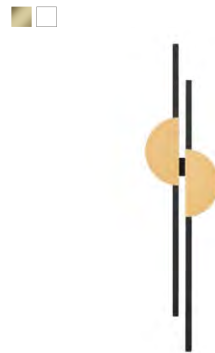

STELO
MOD116 336



TAU
MOD166 342



MIRA
MOD279 346

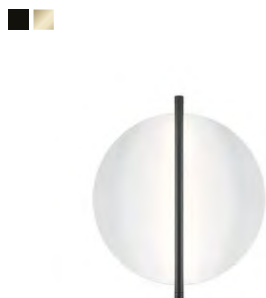

RIM
MOD058 360



IMPRESSIVE
MOD151 376



TALENTO
DIA008 380



MARMO
MOD099 392



BASFOR
DIA100 402



GRACE
RC247 408



OTTILIA
DIA700 412



PALACE
DIA890 414



SEVILLA
DIA004 416



PERLA
ARM337 422



ALICANTE
MOD014 424



ANNA
H007 426



ALBERO
H034 428



BRIONIA
ARM172 429



GRACE
ARM247 431



MESSINA
H233 434



VENERA
H260 436



ZARAGOZA
H001 440



Table lamp

KYOTO
MOD178

66



MEMORY
MOD177

68



BASIC FORM
MOD321

80



INSIGHT
MOD416

82



BREEZE
MOD281

96



ERICH
MOD221

126



AI COLLABORATION
MOD229

136



SPLASH
MOD282

140



AMULET
MOD555

158



MUSE
MOD304

166



RUECA
P060

168



PATTERN
MOD267

185



VERRE
Z005

205



PRIMA
Z034

210



PUNTES
MOD043 236



MOLLIS
MOD126 266



CIPRESSO
Z014 278



ESTUDO
Z010 306



FAD
MOD070 309



RAY
Z012 326



PLONS
MOD283 343



IMPRESSIVE
MOD151 376



TALENTO
DIA008 380



BIANCO
Z031 382



MARMO
MOD099 390



KIWI
Z153 419



ALICANTE
MOD014 424



BRIONIA
ARM172 429



GRACE
RC247 432



ZARAGOZA
H001 440



Floor lamp

KYOTO
MOD178

66



MEMORY
MOD177

69



BREEZE
MOD281

96T



THE SIXTH SENSE
Z020

114

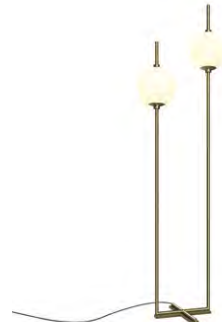

ERICH
MOD221

126



AMULET
MOD555

159



NOSTALGIA
MOD048

170



RING
MOD013

182



PATTERN
MOD267

185



PUNTES
MOD043

236



GOLDEN CAGE
MOD216

262



MOLLIS
MOD126

266

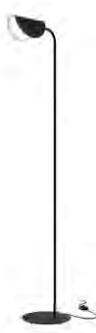

ESTUDO
Z010

306



FAD
MOD070

308



FLOW
MOD147 312



RAY
Z012 326



TAU
MOD166 342



CALVIN
Z177 372



CAMPANULA
Z002 374



MARMO
MOD099 392



SOLID
MOD277 391



ALICANTE
MOD014 424



GRACE
RC247 432



Backlight

BRIS
MIR008 444



DECART
MIR010 445



EPIC
MIR009 446



FICHTE
MIR012 447



FINO
MIR003 448



ORION
MIR011 449



FINELLI
MIR004 450



GOVANNI
PIC119 451



PICASSO
PIC114 452



RENOIR
PIC118 454



Wall lamp

BLOW
O435

472



PULL
O412

474



SHOW
O433

476



STRATO
O417

478



WALD
O420

480



TIMES SQUARE
O581

482



BEEKMAN
O577

484



FULTON
O573

486



BADD
O454

492



BARREL
O453

496



BRICK
O436

502



CANDLE
O449

504



AMAS
O432

506



CELL
O452

508



CONF
0450 512



GLOSS
0447 524



KOLN
0590 532



LOT
0428 538



PIR
OSL456 546



RANDO
0419 552



ROCK
0434 554



ROM
0442 558



ROW
0448 560



SHARE
0443 562



SHATTER
OSL457 564



SPIR
0439 566



STOCK
0446 568



TRUPP
0429 572



VINT
0458 574



WILLIS
0418 578



BAKER STREET
O021 584



DOWNING STREET
O020 586



UNTER DEN LINDEN
O578 588



WALL STREET
O010 590



BOWERY
O574 592



BRONX
O576 594



MEZZO
O033 596



SCOPE
O025 598



BOLD
O598 600



SHIM
O303 610



FLEUR
O414 632



SALAMANCA
O031 636



Pendant

ERDA
O594 518



FLEUR
O414 634



SALAMANCA
O031

636



Ceiling

MON
O438

490



BAR
O306

494



ROLL
O307

556



WILLIS
O418

578



ZON IP
O431

580



ARES
O309

602



SPIN
O310

608



Downlights

BIL
0015

616



BISCOTTI
0036

618



BOSCA
0045

620



LIMO
0037

622



LOCK
0014

624



MANE
0046

626



VIA URBANA
0022

628



Landscape

BARREL
0453

496



BERN
0050

498



BONN
0425 500



AMAS
0432 506



CELL
0452 509



EDGE
0415 514



ELBE
0424 516



ERDA
0594 518

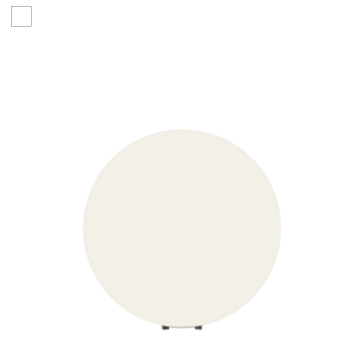

ESSEN
0596 520



GLIDE
0437 522



GUSS
0592 526



HAGEN
0423 528



HOF
0422 530



KOLN
0590 532



LIT
0593 536



MILL
0427 540



OLTEN
0591 542



PASO
0595 544



PIR
OSL456 546



PLET
OSL599 550



SHARE
O443 562



SPIR
O439 566



STOCK
O446 568



TRIM
O455 570



VINT
O458 574



WALD
O420 576



WILLIS
O418 578



ROYAL MILE
O019 582



BAKER STREET
O021 584



UNTER DEN LINDEN
O578 588



WALL STREET
O010 590



BRONX
O576 594



SCOPE
O025 598



BOLD
O598 600



POLE 0440	606	SPEAR 0441	612	FLEUR 0414	632	SALAMANCA 0031	636
							

Accessory

RIM MOD058A	366
	



Universal base

UNIVERSAL BASE SPR-BASE	368
	



Style Index

DECORATIVE

Modern

Glass	64	Bangkok	118	Drop	166	Muse
	66	Kyoto	120	Duality	168	Rueca
	68	Memory	122	Dynamics	170	Nostalgia
	70	Antic	124	Erich	174	Ordo
	72	Arco	128	Fermi	176	Rebel
	74	Aster	130	Eustoma	178	Reels
	76	Basic form	131	Flusso	179	Nebula
	82	Insight	132	Fortano	180	Rendez-vous
	84	Bao	136	AI Collaboration	182	Ring
	86	Avant-garde	138	Cosmo	185	Pattern
	88	Balance	140	Splash	188	Frozen
	90	Balbo	142	Gilbert	190	Miracle
	92	Aura	144	Gioia	192	Ros
	93	Cometa	146	Glassy	194	Sintesi
	94	Bolla	148	Tone	196	Telford
	96	Breeze	150	Irving	197	Tessara
	98	Coctail Time	152	Ligero	198	Tropic
	100	Collar	153	Jackson	200	Ventura
	102	Colline	156	Amulet	202	Verticale
	104	Dallas	158	Lunare	204	Vision
	112	Kazimir	160	Marble	205	Verre
	114	The Sixth Sense	161	Maya		
	116	Touch	164	Mood		

Composition	206 208	Mabell Mare	210 212	Prima Jupiter	214	Rotta
-------------	------------	----------------	------------	------------------	-----	-------

Cristal	216 218 220 222 224	Cerezo Coil Dune Facet Flare	226 228 230 232 236	Frame Gelid Hail Krone Puntes	240 242 243	Revero Wonderland Recinto
---------	---------------------------------	------------------------------------------	---------------------------------	-------------------------------------------	-------------------	---------------------------------

Metal	244 246 248 250 252 254 256	Basic colors Bowi Dynamics El Enigma Gerhard Giro	257 258 260 262 264 266 268	Palette Jack-stone Lovetann Golden Cage Imaginary Mollis Notta	270 272 274 276 278 279	Pixel Plec Sonata Vesper Cipresso Lantern
-------	-----------------------------------------------	---------------------------------------------------------------------	-----------------------------------------------	----------------------------------------------------------------------------------	----------------------------------------	----------------------------------------------------------

Style Index

Minimal	282	Ambience	318	Node	343	Plons
	284	Light stick	320	Peso	344	Radiance
	286	Halo	322	Nuance	346	Mira
	294	Curve	324	Origami	350	Pro Base
	298	Anillo	326	Ray	352	Pro Extra
	300	Axis	328	Renaissance	354	Pro Shade
	302	Cascade	330	Rida	356	Pro Focus
	306	Estudo	332	Saturno	358	Line
	308	Fad	334	Skyline	360	Rim
	312	Flow	336	Stelo	366	Accessories Rim
	314	Glint	338	Supersymmetry	367	Satellite
	316	Motion	340	Tau		

Universal base	368	Universal base
----------------	-----	----------------

Fabric	370	Bergamo	374	Campanula	378	Reflex
	372	Calvin	376	Impressive	380	Talento

Nature	382	Bianco	388	Cane	392	Petra
	384	Bicones	390	Marmo	394	Roots
	386	Broni	391	Solid		

Classic

Cristal	402 404 405 406	Basfor Bella Broche Cascade	408 410 412 414	Grace Karolina Ottilia Palace	416 417	Sevilla Toils
Glass	418 419	Combinare Kiwi	420 421	Pascal Zeil		
	422	Perla				
Fabric	424 426 428	Alicante Anna Albero	429 430 434	Brionia Grace Messina	436 438 440	Venera Vittoria Zaragoza
Backlight	444 445 446 447	Bris Decart Epic Fichte	448 449 450 451	Fino Orion Finelli Giovanni	452 454	Picasso Renoir

Style Index

OUTDOOR

Architectural lighting	472 474 476	Blow Pull Show	478 480 482	Strato Wald Times Square	484 486	Beekman Fulton
Modern lighting	490 492 494 496 498 500 502 504 506 508 512 514 516 518 520 522 524 526 528 530	Mon Badd Bar Barrel Bern Bonn Brick Candle Amas Cell Conf Edge Elbe Erda Essen Glide Gloss Guss Hagen Hof	532 536 538 540 542 544 546 550 552 554 556 558 560 562 564 566 568 570 572 574	Koln Lit Lot Mill Olten Paso Pir Plet Rando Rock Roll Rom Row Share Shatter Spir Stock Trim Trupp Vint	576 578 580 582 584 586 588 590 592 594 596 598 600 602 606 608 610 612	Wald Willis Zon IP Royal Mile Baker Street Downing Street Unter den Linden Wall Street Bowery Bronx Mezzo Scope Bold Ares Pole Spin Shim Spear

Light for walls, stairs and paths	616 618 620	Bil Biscotti Bosca	622 624 626	Limo Lock Mane	628	Via Urbana
--------------------------------------	-------------------	--------------------------	-------------------	----------------------	-----	------------

Classic lighting	632	Fleur	636	Salamanca
------------------	-----	-------	-----	-----------

SPECTACULI MOMENTAR TS





**THE LIGHT
IN THE NIGHT
THE
PRESENT**

SPECTACULAR MOMENTS

Maytoni Decorative

OF DECORATIVE LIGHTING

Maytoni Decorative

Three critical questions

Drei entscheidende Fragen

1. What is the lighting's purpose?

Was ist der Zweck der Beleuchtung?

2. What are the elements we intend to illuminate?

Welche Elemente sollen beleuchtet werden?

3. What product is best suited for the application?

Welches Produkt ist für die Anwendung am besten geeignet?

Light Concept: An introspective approach to lighting planning results in functional living spaces that are comfortable. They unlock the visual appeal of the surrounding design and architecture, providing clear zones within the space.

To create lighting that caters to the needs of individuals rather than merely the surroundings, it is imperative to first define the objectives and requirements. Subsequently, the layout and placement of fixtures can be evaluated in relation to the furniture.

Lichtkonzept: Eine introspektive Herangehensweise an die Lichtplanung führt zu funktionalen und komfortablen Lebensräumen. Sie betonen das Design und die Architektur der Umgebung und schaffen klare Zonen innerhalb des Raums.

Um eine Beleuchtung zu schaffen, die sich an den Bedürfnissen der Menschen und nicht nur an der äußeren Umgebung orientiert, ist es unerlässlich, zunächst die Ziele und Anforderungen zu definieren. Anschließend kann die Verteilung und Positionierung der Leuchten in Bezug auf die Möblierung festgelegt werden.

Example of a functional room layout →

Beispiel für einen funktionellen Raumaufteilung→

Read a new book before going to bed

Watch a movie

Get a good night's rest for the upcoming workweek

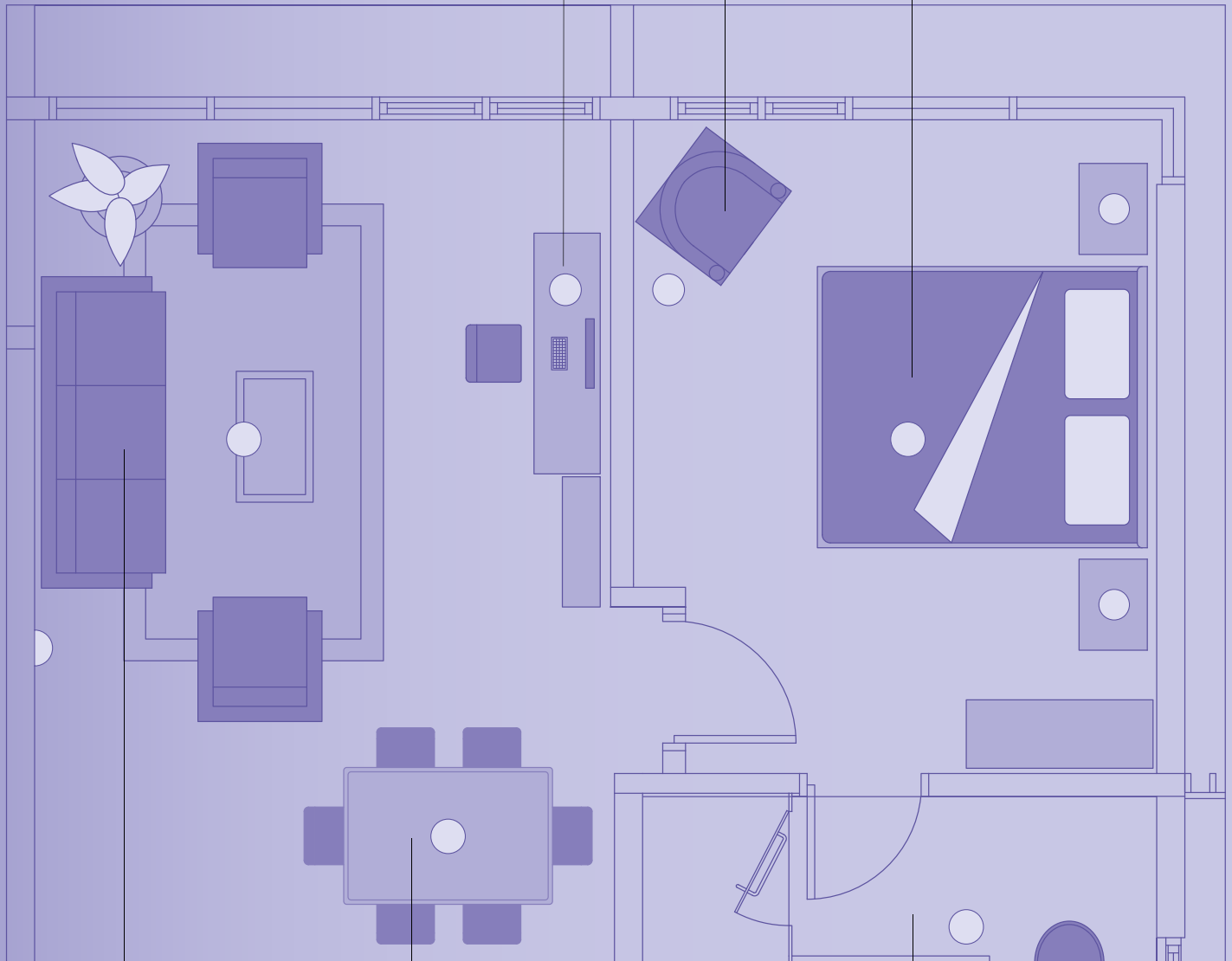

Reunite with old friends and play board games

Treat yourself to a spa day

Host a family get-together

Three layers of illumination

Drei Beleuchtungsebenen

To holistically illuminate a space, it is essential to apply a multi-faceted lighting solution.

Um einen Raum ganzheitlich zu beleuchten, ist eine vielschichtige Beleuchtungsstrategie erforderlich.



● General lighting

Allgemeine Beleuchtung

(track lighting systems, spotlights, and pendant luminaires)

(Schienenbeleuchtungssysteme, Strahler und Pendelleuchten)

This layer provides ample illumination for navigating the space.

Diese Beleuchtungsebene sorgt für eine ausreichende Beleuchtung, um sich im Raum zurechtzufinden.

○ Accent Lighting

Akzent Beleuchtung

(track lighting systems, pendant and ceiling luminaires)

(Schienenbeleuchtungssysteme, Pendel- und Deckenleuchten)

Eine gerichtete Lichtebeleg, die bestimmte Zonen und Brennpunkte im Raum akzentuiert.

○ Decorative Lighting

Dekorative Beleuchtung

(wall, floor, and portable luminaires)

(Wand-, Boden- und tragbare Leuchten)

This localised layer of light enhances the visual appeal of the interior, introducing additional aesthetic elements.

Diese örtlich begrenzte Lichtebeleg erhöht die visuelle Attraktivität des Innenraums und führt zusätzliche ästhetische Elemente ein.



General Lighting
Unity track lighting system



Accent Lighting
LED strip



Decorative Lighting
Tau pendant and wall lights

Three light diffusion categories

Drei Kategorien der Lichtstreuung

To select the appropriate luminaire, you need to understand the light diffusion characteristics. The fundamental types of light diffusion include:

Um die richtige Leuchte auszuwählen, müssen Sie die Eigenschaften der Lichtstreuung kennen. Zu den grundlegenden Arten der Lichtstreuung gehören:

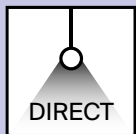

Direct

Direkt

The beam is directed towards a specific object

Der Lichtstrahl ist auf ein bestimmtes Objekt gerichtet

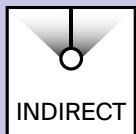

Indirect

Indirekt

The beam strikes a surface and is reflected from it onto the target object

Der Lichtstrahl trifft auf eine Oberfläche und wird von dieser auf das Zielobjekt reflektiert

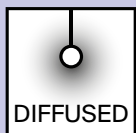

Diffused

Diffus

Light that radiates uniformly around the source

Licht, das sich gleichmäßig um eine Lichtquelle herum ausbreitet

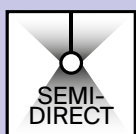

Mixed

Gemischt

There are also hybrid variations that blend direct and indirect light, with a principal focus on each.

Es gibt auch Mischformen, bei denen direktes und indirektes Licht gemischt werden, wobei der Schwerpunkt auf beiden liegt

Three dimensions of spatial illumination

Drei Dimensionen der Raumausleuchtung

Working with diverse layers of light offers you more than just volume; it transforms the space, allowing you to control shadows and contrasts. Such artistry also extends to managing the illumination of expansive surfaces.

Die Arbeit mit verschiedenen Lichtebenen bietet mehr als nur Volumen; sie verwandelt den Raum und ermöglicht die Kontrolle von Schatten und Kontrasten. Diese Kunst lässt sich auch auf die Beleuchtung großer Flächen übertragen.

Lighting the floor and ceiling gives a sense of height to the room.

Die Beleuchtung von Boden und Decke verleiht dem Raum Höhe.

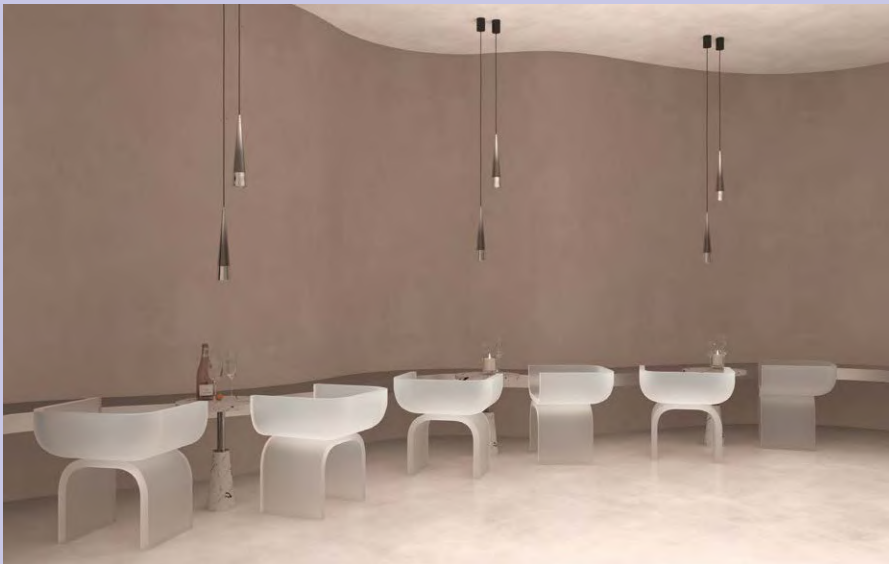

An illuminated wall expands the perception of space.

Eine beleuchtete Wand vergrößert optisch den Raum.



Space transformation techniques →

Techniken der Raumverwandlung



Strategic light distribution along the outside of ceilings and walls visually elevates and broadens the space.

Durch die gezielte Lichtverteilung entlang der Außenseiten von Decken und Wänden wird der Raum optisch erhöht und vergrößert.



Strategic light distribution along the outside of walls visually broadens the space.

Durch die gezielte Lichtverteilung entlang der Außenseiten von Wänden wird der Raum optisch vergrößert.



Illuminating the ceiling and side walls visually 'elongates' the room, seemingly reducing its length while enhancing its height and width.

Durch die Beleuchtung der Decke und der Seitenwände wird der Raum „gestreckt“, wodurch seine Länge verkürzt und seine Höhe und Breite vergrößert werden.



Balancing light between the floor and side walls visually alters the room's dimensions, simultaneously enlarging and shortening its appearance.

Durch das Ausbalancieren des Lichts zwischen Boden und Seitenwänden werden die Raumdimensionen visuell verändert und der Raum gleichzeitig vergrößert und verkürzt.



Backlighting the ceiling and the distant wall creates a fascinating elongated tunnel effect, resulting in the room appearing taller.

Durch die Hinterleuchtung der Decke und der entfernten Wand entsteht ein faszinierender, langgestreckter Tunnelleffekt, der den Raum höher erscheinen lässt.



Conversely, darkening the far wall dramatically truncates the space.

Umgekehrt wird der Raum durch die Verdunkelung der gegenüberliegenden Wand dramatisch verkürzt.



With dimmed side walls, the room takes on a narrower feel as it 'slides' closer to the floor, ceiling, and back wall.

Wenn die Seitenwände abgedunkelt werden, wirkt der Raum schmaler, da er näher an Boden, Decke und Rückwand «heranrückt».



Strategically distributing light on the ceiling and floor creates a sense of heightened space but may make the space feel more enclosed.

Die strategische Verteilung des Lichts auf Decke und Boden erzeugt ein Gefühl von Weite, kann aber auch dazu führen, dass der Raum geschlossener wirkt.



Applying this same concept to the ceiling and side walls makes the room expand towards the back wall, making the light-coloured floor almost disappear.

Wendet man dasselbe Konzept auf die Decke und die Seitenwände an, dehnt sich der Raum zur Rückwand hin aus und lässt den hellen Boden fast verschwinden.



Darkening the outside walls gives an enclosed feel, visually heightening the room.

Werden die Außenwände abgedunkelt, entsteht ein geschlossener Eindruck, der den Raum optisch vergrößert.



Floor-level lighting tends to make the room feel cosier and somewhat cave-like.

Eine bodennahe Beleuchtung lässt den Raum gemütlicher und etwas höhlenartig erscheinen.



The act of dimming the ceiling, floor, and walls drastically narrows the room, giving a box-like effect.

Durch das Abdunkeln von Decke, Boden und Wänden wird der Raum stark verengt und es entsteht ein kastenartiger Effekt.

Lighting design for rooms: practical insights

Lichtgestaltung im Raum: praktische Tipps

Every room serves not only as a designated space but also as an area where light is assigned a specific role. Therefore, the selection of lighting fixtures must prioritise the harmony of aesthetics and functionality.

Jedes Zimmer ist nicht nur ein eigenständiger Raum, sondern auch ein Bereich, in dem dem Licht eine bestimmte Aufgabe zukommt. Es ist daher sehr wichtig, die Leuchten so auszuwählen, dass ihre Kombination sowohl ästhetisch ansprechend als auch funktional ist.

Corridor
Basic Form pendants
Avant-garde wall luminaire
Memory table lamp
Trinity track lighting system
Focus LED ceiling luminaires



Bathroom
Collar pendants





Kitchen
 Maya pendant lights
 Exility track lighting system
 (Maytoni Technical)



Living room
 Tau pendant light
 Unity track lighting system
 Alfa LED downlight
 Memory floor and table lamps



Bedroom
 Fad pendant and wall lights
 Sintesi single pendants
 Share recessed ceiling lights

GLASS	P. 64
COMPOSITION	P. 206
CRYSTAL	P. 216
METAL	P. 244
MINIMAL	P. 282
UNIVERSAL BASE	P. 368
FABRIC	P. 370
NATURE	P. 380

MODERN

Modern Lighting

LIGHTING

Maytoni Decorative

SPECTACULAR MOMENTS



OF TOTAL LOOK

Surrounded by kindred spirits who understand the language of design, each pairing emerges as superlative, every fusion finds the zenith of perfection. Here, my contours resonate with our collective identity, and my lines intertwine with the tapestry of ours. Total compatibility, as our celestial guides proclaim.

Behold, a compendium of luminous ensembles under the Total Look concept, ensuring harmonious silhouettes in their most exquisite renditions.

Bankok P. 64
Kyoto P. 66
Memory P. 68



Bangkok

B



EN Fittings material – metal, shade – black. Unique design of minimalistic glass dome lamps in three shades – smoky, transparent and gray. LED light source, color temperature - 3000K. Adjustable length of cables.

DE Material der Beschläge - Metall, Farbton - Schwarz. Einzigartiges Design der minimalistischen Lampenschirmen aus Glas in drei Farbtönen – Rauch, Transparent und Grau. LED-Lichtquelle, Farbtemperatur - 3000K Einstellbare Länge von Seilen.

IT Il materiale dell'armatura è il metallo, il colore è nero. I paralumi minimalisti in vetro in tre colori - fumoso, trasparente e grigio, realizzati in un design unico. L'illuminazione a LED, la temperatura del colore-3000 K. La lunghezza dei cavi e' regolabile.

FR Matériel de l'armature - métal, teinte - noir. Design unique des abat-jour en verre minimalistes en trois teintes - fumé, transparent et gris. Source de lumière LED, température de couleur - 3000K. Longueur de câble réglable.



1,4 ■



2,5 ■



3,6 ■

1 ■ **MOD185PL-L6B3K1**

LED 11W 400lm
t° 3000K >80Ra 120°
IP 20

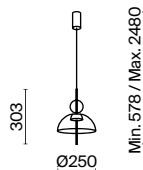

2 ■ **MOD185PL-L6B3K2**

LED 11W 400lm
t° 3000K >80Ra 120°
IP 20

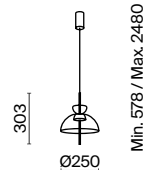

3 ■ **MOD185PL-L6B3K3**

LED 11W 400lm
t° 3000K >80Ra 120°
IP 20

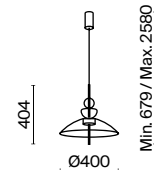



MOD185PL-L6B3K3

MOD185PL-L6B3K2

MOD185PL-L6B3K1

MOD185PL-L6B3K4

4 ■ MOD185PL-L6B3K4
■ MOD185PL-L11B3K1

LED 11W 200lm
t° 3000K >80Ra 120°
IP 20

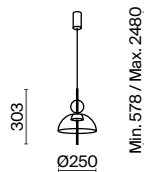

5 ■ MOD185PL-L6B3K5
■ MOD185PL-L11B3K2

LED 11W 250lm
t° 3000K >80Ra 120°
IP 20

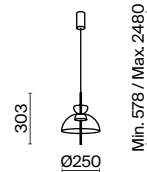

6 ■ MOD185PL-L6B3K6
■ MOD185PL-L11B3K3

LED 11W 300lm
t° 3000K >80Ra 120°
IP 20

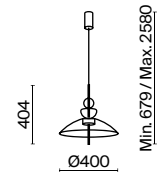

Kyoto



EN Fittings material – metal, shades – black, gold, white. Marble base in black, gray, white colors. Dome lamps are made of white glass. The design of the lamp is inspired by the architecture of the ancient Japanese capital of the same name – Kyoto. LED light source, color temperature – 3000K. Availability of models for lamps with G9 base.

DE Material der Beschläge - Metall, Farbtöne - Schwarz, Gold, Weiß. Marmorbasis in Schwarz, Grau, Weiß. Lampenschirme aus weißem Glas. Das Design der Leuchte ist inspiriert von der Architektur der gleichnamigen alten japanischen Hauptstadt - Kyoto. LED -Lichtquelle, Farbtemperatur - 3000K. Verfügbarkeit von Modellen für Leuchtmittel mit G9-Fassung.

IT Il materiale dell'armatura è il metallo, il colore è nero, oro, bianco. La fondazione è in marmo nei colori nero, grigio, bianco. I paralumi sono in vetro bianco. Il design della lampada è ispirato all'architettura dell'antica capitale giapponese di Kyoto. L'illuminazione a LED, la temperatura del colore-3000 K. Disponibilità dei modelli per la lampadina con un portalampada G9.

FR Matériel de l'armature - métal, teintes - noir, or, blanc. Coulot en marbre noir, gris, blanc. Abat-jour en verre blanc. Le design de la lampe s'inspire de l'architecture de l'ancienne capitale japonaise homonyme - Kyoto. Source de lumière LED, température de couleur - 3000K. Disponibilité de modèles pour lampes avec culot G9.



- 1 ■ MOD178FL-L11B3K
- MOD178FL-L11G3K
- MOD178FL-L11W3K

LED 11W 1300lm
 t° 3000K >80Ra 120°
 IP 20

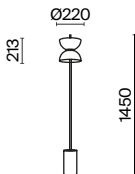

- 2 ■ MOD178PL-01B
- MOD178PL-01GR
- MOD178PL-01W

1 x G9 28W
 IP 20

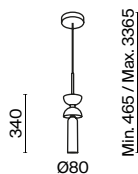

- 3 ■ MOD178PL-L11B3K
- MOD178PL-L11G3K
- MOD178PL-L11W3K

LED 11W 1300lm
 t° 3000K >80Ra 120°
 IP 20

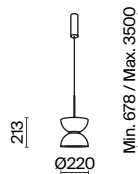

- 4 ■ MOD178TL-L11B3K
- MOD178TL-L11GR3K
- MOD178TL-L11W3K

LED 11W 350lm
 t° 3000K >80Ra 240°
 IP 20

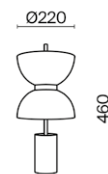



MOD178PL-L11B3K

Memory

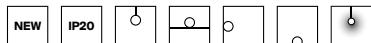
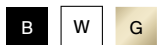

EN Metal fittings, shade – black. Lamps are stylized in the shape of an hourglass with a streamlined shape. Ceramic elements with glossy glaze. Pendant lamps with dome lamps made of white ceramics with transparent, black-and-white, gold-and-white and white glass. Adjustable height of pendant lamps.

DE Metallbeschläge, Farbton - Schwarz. Die Leuchten haben die stilisierte Form einer Sanduhr mit der Stromlinienform. Keramikelemente mit glänzenden Glasur. Pendelleuchten mit Lampenschirmen aus Weißkeramik mit Transparentem, Schwarz-Weißem, Gold-Weißem und Weißem Glas. Pendelleuchten mit einstellbarer Höhe.

IT L'armatura metallica, il colore è nero. Le lampade sono stilizzate a una clessidra sotto forma aerodinamica. Gli elementi in ceramica con lo smalto lucido. Le lampade a sospensione con i paralumi in ceramica bianca con i vetri trasparente, bianco - nero, oro-bianco e bianco. Le lampade a sospensione sono regolabili in altezza.

FR Armature métallique, teinte - noir. Les lampes sont stylisées sous la forme d'un sablier à la forme profilée. Éléments en céramique avec glaçure brillante. Lampes à suspension avec abat-jour en céramique blanche avec verre clair, noir et blanc, blanc or et blanc. Lampes à suspension réglables en hauteur.



1 ■ **MOD177PL-01B**
 □ **MOD177PL-01W**
 ■ **MOD177PL-01G**

2 ■ **MOD177PL-04B**

3 ■ **MOD177WL-01B**

4 ■ **MOD177TL-01B**
 □ **MOD177TL-01W**

💡 1 x E14 40 W
 IP 20

💡 4 x E14 40 W
 IP 20

💡 1 x E14 40 W
 IP 20

💡 1 x E14 40 W
 IP 20

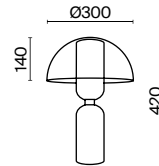
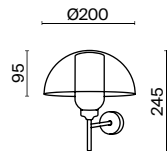
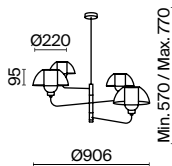
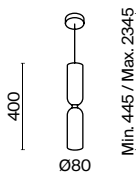



MOD177FL-01B

MOD177PL-04B

MOD177TL-01B

5 ■ **MOD177FL-01B**

💡 1 x E14 40W
IP 20

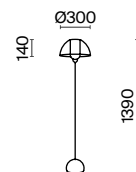

Antic

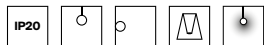

EN Metal fittings plated in gold color. Dome lamp of cast glass with a corrugated texture, shades – white, cognac, grey. Light source – lamp with E14 base.

DE Metallbeschläge, galvanisiert im Farbton Gold. Lampenschirme aus gegossenem Glas mit geriffelter Textur, Farbtöne: Weiß, Cognac, Grau. Lichtquelle: Leuchtmittel mit E14-Fassung.

IT L'armatura in metallo è galvanizzata in colore oro. Plafoniera in vetro colato goffrato, sfumature: bianco, cognac, grigio. La sorgente luminosa è una lampadina con attacco E14.

FR Armature en métal galvanisée de couleur dorée. Globe en verre coulé avec texture ondulée, teinte : blanc, cognac, gris. Source de lumière : ampoule à culot E14.



1 **MOD302PL-01GR**
MOD302PL-01CG
MOD302PL-01W

⚡ 1 × E14 40 W
 IP 20

2 **MOD302WL-02GR**
MOD302WL-02CG
MOD302WL-02W

⚡ 2 × E14 40 W
 IP 20

3 **MOD302WL-01GR**
MOD302WL-01CG
MOD302WL-01W

⚡ 1 × E14 40 W
 IP 20

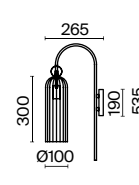
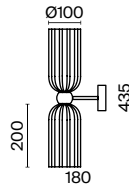
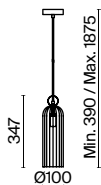



Arco

BS

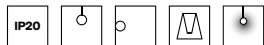

EN Metal fittings are galvanized in brass color. The dome lamps are made of transparent blown glass with a relief texture. Adjustable height of pendant lamps.

DE Metallbeschläge sind messingfarben galvanisiert. Lampenschirme aus dem transparenten mundgeblasenen Glas mit Reliefstruktur. Verstellbare Höhe der Pendelleuchten.

IT L'armatura in metallo è zincata nel colore dell'ottone. I paralumi sono in vetro soffiato trasparente con una texturazione in rilievo. Le lampade a sospensioni sono regolabili in altezza.

FR L'armature métallique est galvanisée en couleur de laiton. Les abat-jour sont en verre soufflé transparent avec une texture en relief. Hauteur réglable des suspensions.



1



2



3



4

MOD223PL-06BS

6 x G9 40W
IP 20

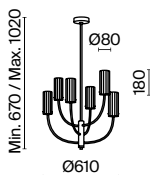

MOD223PL-03BS

3 x G9 40W
IP 20

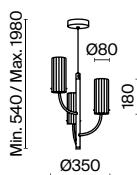

MOD223WL-02BS

2 x G9 40W
IP 20

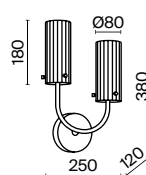

MOD223WL-02BS1

2 x G9 40W
IP 20

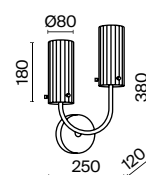



Aster

G

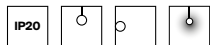

EN Metal fittings of gold color. Spherical decorative elements of molded corrugated glass. The combination of amber and transparent shades in the decoration. Adjustable height. Light source – lamps with E14 base.

DE Metallbeschläge in Gold. Sphärischer Dekor aus gestanztem Reliefglas. Eine Kombination aus bernsteinfarbenem und transparentem Farbton im Dekor. Einstellbare Höhe. Lichtquelle: Leuchtmittel mit E14-Fassung.

IT Armatura in metallo color oro. Decoro sferico in vetro goffrato stampato. Una combinazione di sfumature ambrate e trasparenti nel decoro. Altezza regolabile. Sorgente luminosa - lampadine con attacco E14.

FR Armature métallique de couleur dorée. Élément décoratif sphérique en verre gaufré estampé. Combinaison des teintes ambre et transparente dans l'élément décoratif. Réglable en hauteur. Source de lumière: ampoules à culot E14.



1



2



3



4

MOD007PL-10G

10 × E14 40W
IP 20

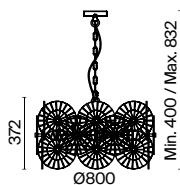

MOD007PL-08G

8 × E14 40W
IP 20

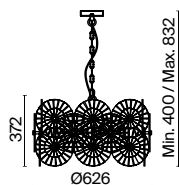

MOD007WL-01G

1 × E14 40W
IP 20

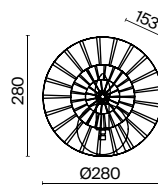

MOD007PL-08G1

8 × E14 40W
IP 20

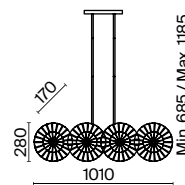



Basic form

G B



EN Fittings material – metal, shades – gold, black. Rounded dome lamps made of frosted white glass. Versatile shapes, minimalistic design. E14 base. Lamps are not included. Adjustable height of pendant lamps.

DE Material der Beschläge: Metall. Farbtöne: Gold, Mattes Schwarz. Rundliche Lampenschirme aus weißem Milchglas. Universelle Formen, minimalistisches Design. E14-Fassung. Lampen nicht im Lieferumfang enthalten. Pendelleuchten mit einstellbarer Höhe.

IT Material del herraje: metal. Matices: dorado, negro mate. Plafones redondos de vidrio blanco mate. Formas universales, diseño minimalista. Casquillo: E14. Las lámparas no están incluidas. Luminarias colgantes regulables en altura.

FR Matériel de l'armature : métal. Teintes : dorée, noir mat. Globes arrondis en verre blanc mat. Formes universelles, design minimaliste. Culot E14. Les lampes ne sont pas incluses. Lampes à suspension réglables en hauteur.



1



2



3



4

1 **MOD521PL-03G**

3 x G9 20 W
IP 20

2 **MOD521PL-05G**

5 x G9 20 W
IP 20

3 **MOD521WL-01G1**

1 x G9 20 W
IP 20

4 **MOD521WL-01G3**

1 x G9 20 W
IP 20

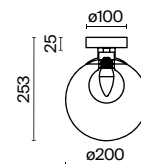
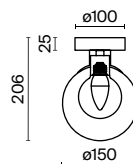
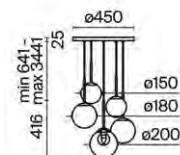
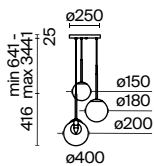



MOD521PL-01G

Basic form



5



6



7



8

5 ■ **MOD521PL-01G1**

💡 1 x G9 20W
IP 20

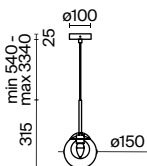

6 ■ **MOD521PL-01G3**

💡 1 x G9 20W
IP 20

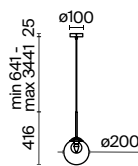

7 ■ **MOD321PL-01G1**

💡 1 x E14 40W
IP 20

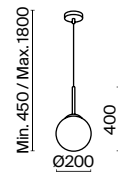

8 ■ **MOD321PL-01G3**

💡 1 x E14 40W
IP 20

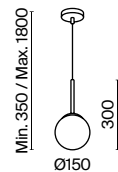



9 ■ ■



10 ■ ■



11 ■



12 ■

9 ■ **MOD321PL-05B**
■ **MOD321PL-05G1**

💡 5 x E14 40 W
IP 20

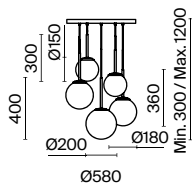

10 ■ **MOD321PL-03B**
■ **MOD321PL-03G1**

💡 3 x E14 40 W
IP 20

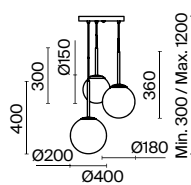

11 ■ **MOD321PL-01B**

💡 1 x E14 40 W
IP 20

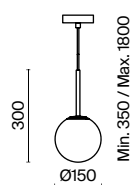

12 ■ **MOD321PL-01B1**

💡 1 x E14 40 W
IP 20

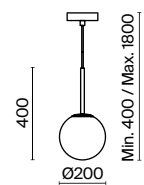

Basic form



13 



14  





15 





16  

13  **MOD321WL-01G2**

14  **MOD321WL-01B1**
 **MOD321WL-01G3**

15  **MOD321TL-01G3**

16  **MOD321WL-01B**
 **MOD321WL-01G1**

💡 1 × E14 40 W
IP 20

💡 1 × E14 40 W
IP 20

💡 1 × E14 40 W
IP 20

💡 1 × E14 40 W
IP 20

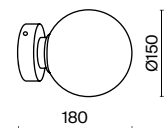
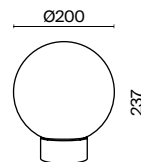
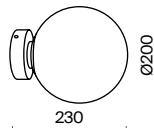
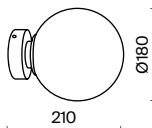



17 



18 



19 

17  **MOD321PL-05G**

💡 5 x E14 40W
IP 20

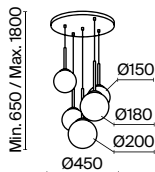

18  **MOD321PL-03G**

💡 3 x E14 40W
IP 20

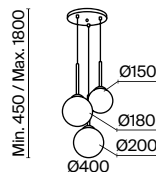

19  **MOD321PL-01G2**

💡 1 x E14 40W
IP 20

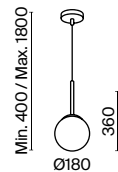

Insight

B



EN Fittings material— metal. Color – black. Bidirectional light flux. Decorative elements— tinted acrylic. LED sources are covered with a matte diffuser. Color temperature is 3000K.

DE Material der Beschläge: Metall. Farbton: Schwarz. Bidirektionaler Lichtstrom. Dekor: getöntes Acryl. LED-Lichtquellen, von einem matten Diffusor abgedeckt. Farbtemperatur 3000K.

IT Materiale dell'armatura - metallo. Colore nero. Flusso luminoso bidirezionale. Decoro: acrilico colorato. Le sorgenti LED sono ricoperte da un diffusore opaco. Temperatura di colore 3000K.

FR Matériau de l'armature: métal. Couleur : noir. Flux lumineux bidirectionnel. Élément décoratif : acrylique teinté. Sources LED dissimulées par un diffuseur mat. Température de couleur 3000K.



1 ■

1 ■ **MOD416TL-L6BR3K**

LED 6W 550lm
 t° 3000K >80Ra 180°
 IP 20

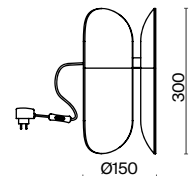



MOD416TL-L6BR3K



Bao

G B

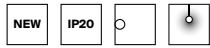

EN Fittings material – metal, shades – black, gold. Dome lamps are made of white matte glass. G9 base. Lamps are not included.

DE Material der Beschläge - Metall, Farbtöne - Schwarz, Gold. Lampenschirme aus weißem Milchglas. G9-Fassung. Lampen nicht im Lieferumfang enthalten.

IT Il materiale dell'armatura è il metallo, i colori sono nero ed oro. I paralumi sono in vetro bianco opaco. Il portalampada è G9. Le lampadine non sono disponibili su questo modello.

FR Matériel de l'armature - métal, teinte - noir, or. Abat-jour en verre opaque blanc. Culot G9. Les lampes ne sont pas incluses.



1 ■ ■

1 ■ **MOD419WL-01B**
■ **MOD419WL-01G**

💡 1 × G9 28 W
IP 20

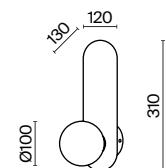

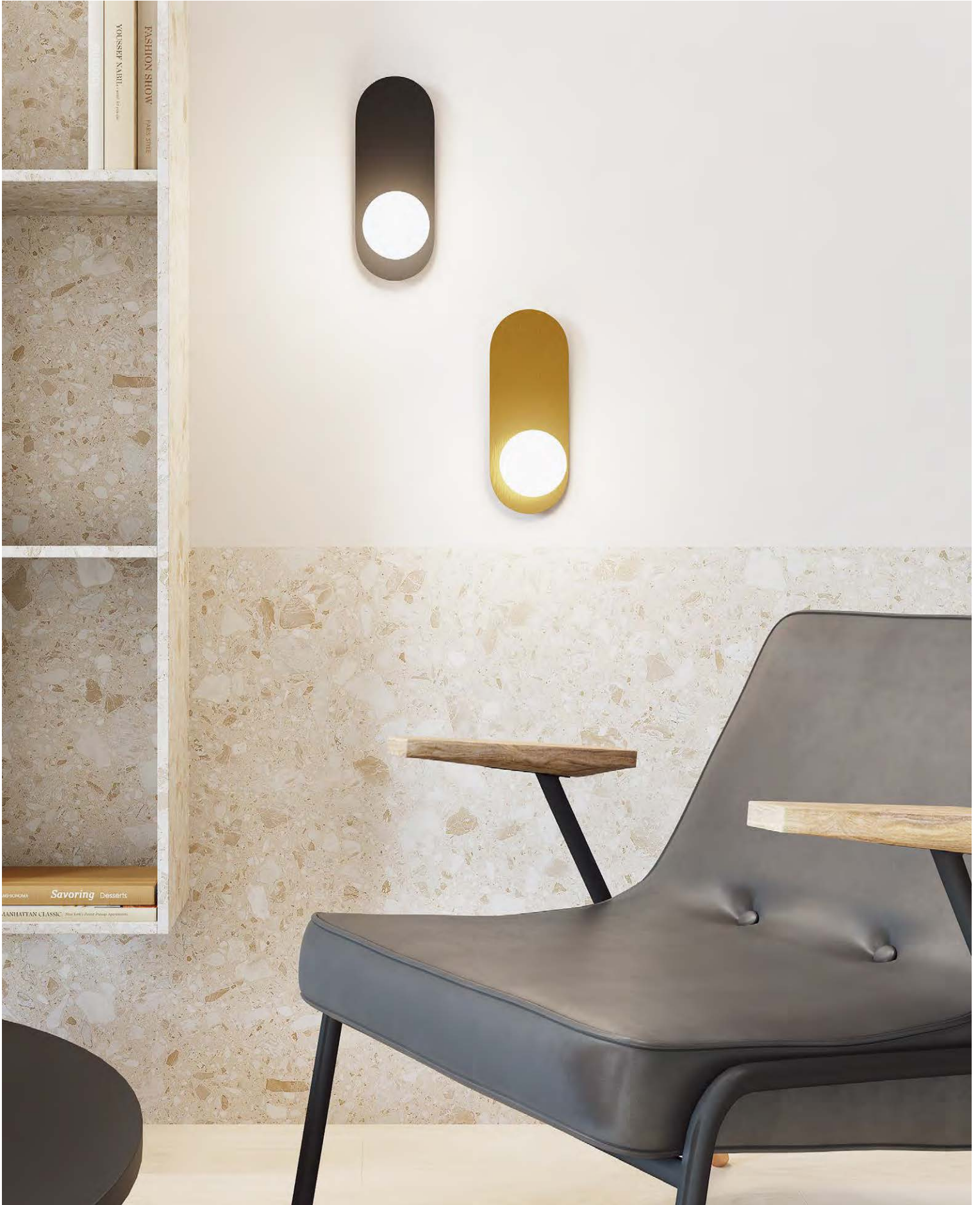

Avant-garde

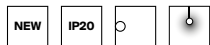

EN Metal fittings, shades – matte black, brass, chrome. Spherical dome lamp – glass, color – white. Hidden mount. Original geometry in design. Clear shady pattern.

DE Metallbeschläge, Farbtöne: mattes Schwarz, Messing, Chrom. Kugelförmiger Lampenschirm aus Glas, Farbton: Weiß. Verdeckte Befestigung. Eigenartige Geometrie im Design. Blankes Schattenbild.

IT Armatura in metallo, Plafoniere: nero opaco, ottone, cromo. Plafoniera-sfera - vetro, colore - bianco. Ganci nascosti. Geometria originale nel design. Pulito disegno d'ombra.

FR Armature en métal, teintes : noir mat, laiton, chrome. Globe sphérique en verre blanc. Fixation dissimulée. Géométrie au design original. Dessin d'ombre net.



1 ■ **MOD324WL-01B**
 ■ **MOD324WL-01BS**
 ■ **MOD324WL-01CH**

💡 1 × G9 25W
 IP 20

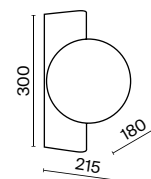



Balance

G

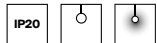

EN Metal fittings in black color. Dome lamps of frosted blown glass are mounted on metal arcs. Height is adjustable using cables. Light source – lamps with G9 base.

DE Metallbeschläge in Schwarz. Lampenschirme aus geblasenem Glas, mit Befestigung an Metallbögen. Durch Seile einstellbare Höhe. Lichtquelle: Leuchtmittel mit G9-Fassung.

IT L'armatura e' in metallo di color nero. Le plafoniere sono realizzate in vetro soffiato opaco e sono fissate ad archi in metallo. L'altezza è regolabile con cavi. Sorgente luminosa - lampadine con attacco G9.

FR Armature en métal en noir. Les globes en verre soufflé mat sont fixés sur des arceaux métalliques. La hauteur est réglable à l'aide d'un câble. Source de lumière : ampoules à culot G9.



1



2

1 **MOD317PL-06G**

6 x G9 40W
IP 20

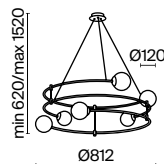

2 **MOD317PL-04G**

4 x G9 40W
IP 20

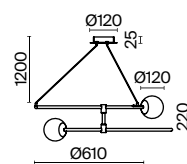



MOD317PL-06G

Balbo

SM CG
N N



EN Metal fittings in nickel color. Dome lamps of transparent glass in two colors: smoky and cognac. Light source – lamps with G9 base.

DE Metallbeschläge in Nickel. Lampenschirme aus transparentem Glas in zwei Farbtönen: Rauch und Cognac. Lichtquelle: Leuchtmittel mit G9-Fassung.

IT Armatura in metallo color nichel. Plafoniere in vetro trasparente in due tonalità: fumé e cognac. Sorgente luminosa - lampadine con attacco G9.

FR Armature métallique de couleur nickel. Globes en verre transparent en deux teintes : fumé et cognac. Source de lumière : ampoules à culot G9.



1 ■ ■



2 ■ ■



3 ■ ■

1 ■ **MOD112-04-N**
■ **MOD112-04-G**

⚡ 4 x G9 28 W
IP 20

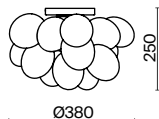

2 ■ **MOD112-08-N**
■ **MOD112-08-G**

⚡ 8 x G9 28 W
IP 20

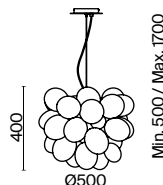

3 ■ **MOD112CL-08N**
■ **MOD112CL-08G**

⚡ 8 x G9 28 W
IP 20

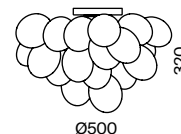



Aura

BS



EN Metal fittings, color – brass. Dome lamps – double blown glass. Internal part– frosted, external – transparent. Elegant neoclassic, trendy rounded shapes.

DE Metallbeschläge, Farbton: Messing. Lampenschirme: doppeltes geblasenes Glas. Innenseite matt, Außenseite transparent. Elegante Neoklassik, trendige abgerundete Formen.

IT Armatura in metallo, colore - ottone. Plafoniere - doppio vetro soffiato. L'interno è opaco, l'esterno è trasparente. Eleganti forme arrotondate neoclassiche alla moda.

FR Armature métallique, couleur laiton. Globe en verre double soufflé. Partie intérieure mate, partie extérieure transparente. Néoclassique élégant, formes arrondies tendance.



1 ■ **MOD016PL-06BS**

💡 6 × E14 60 W
IP 20

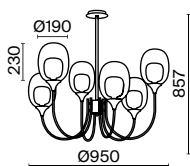

2 ■ **MOD016WL-01BS**

💡 1 × E14 60 W
IP 20

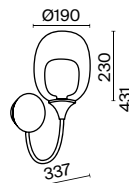

3 ■ **MOD016PL-01BS**

💡 1 × E14 60 W
IP 20

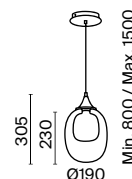

Cometa

MG

LED

IP20



EN Fittings material— metal, color – frosted gold. Dome lamp of transparent blown glass. LED light source. Adjustable height.

DE Metallbeschläge, Farbton: Mattes Gold. Lampenschirm aus transparentem geblasenem Glas. LED-Lichtquelle. Einstellbare Höhe.

IT Materiale dell'armatura - metallo, colore - oro opaco. Plafoniera in vetro soffiato trasparente. Sorgente luminosa a LED. Altezza regolabile.

FR Matériel de l'armature : métal, couleur : dorée mat. Globe en verre soufflé transparent. Source de lumière LED. Hauteur réglable.



1

1 ■ **MOD056PL-L12G3K**

LED 12W 750lm
 t° 3000K >80Ra 360°
 IP 20

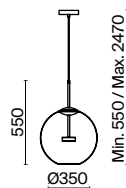

Bolla

BS



EN Fittings: metal, color: brass. Spherical dome lamps of blown glass. Plated coating of dome lamps in amber color. Light source – lamps with E27 base.

DE Metallbeschläge, Farbe - Messing. Kugelförmige Lampenschirme aus geblasenem Glas. Galvanische Beschichtung der Lampenschirme in Bernstein. Lichtquelle: Leuchtmittel mit E27-Fassung.

IT L'armatura è il metallo, il colore è l'ottone. Sfere in vetro soffiato. Plafoniere galvanizzate in colore ambra. Sorgente luminosa - lampadine con attacco E27.

FR Armature - métal, teintes - laiton. Globes sphériques en verre soufflé. Revêtement galvanisé des globes de couleur ambre. Source de lumière : ampoules à culot E27.



1



2

1 ■ **MOD133CL-04BS**

⚡ 4 × E27 60 W
IP 20

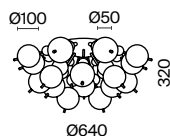

2 ■ **MOD133PL-06BS**

⚡ 6 × E27 60 W
IP 20

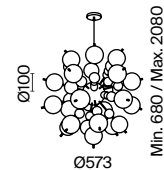



MOD133PL-06BS

Breeze

BS



EN Metal fittings, color: brass. Decorative elements made of transparent textured acrylic. LED light source. Color temperature: 3000K. Suspended lamps: a 3-meter adjustable wire. Table and floor models with a dimming function.

DE Material der Beschläge - Metall, Farbe - Messing. Dekorative Elemente aus transparentem, strukturier-tem Acryl. LED-Lichtquelle mit einer Farbtemperatur von 4000K. Pendelleuchten - 3 Meter verstellbares Kabel. Tisch- und Standmodelle mit Dimmfunktion.

IT Il materiale dell'armatura è il metallo, il colore è ottone. Gli elementi decorativi realizzati in un acrilico trasparente strutturato. La sorgente luminosa a LED con la temperatura di colore di 3000K. Le lampade a sospensione sono un cavo regolabile della lunghezza di 3 metri. I modelli da tavolo e da pavimento con la funzione di dimmerazione.

FR Matériau de montage - métal, couleur - laiton. Éléments décoratifs en acrylique texturé transparent. Source de lumière LED avec une température de couleur de 3000K. Suspensions - fil réglable de 3 mètres de long. Modèles de table et sur pied avec fonction de gradation.



1



2



3



4



5

1 **MOD281CL-L45BS3K** 2 **MOD281PL-L45BS3K** 3 **MOD281PL-L34BS3K**

LED 45W 2700lm
t° 3000K >80Ra 180°
IP 20

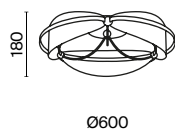

LED 45W 2700lm
t° 3000K >80Ra 180°
IP 20

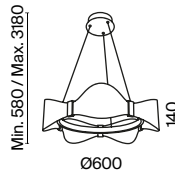

LED 33W 2040lm
t° 3000K >80Ra 180°
IP 20

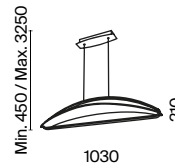



MOD281PL-L34BS3K

4 ■ MOD281FL-L33BS3K 5 ■ MOD281TL-L15BS3K

LED 33W 1980lm
 t° 3000K >80Ra 180°
 IP 20

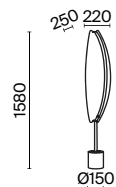

LED 16W 870lm
 t° 3000K >80Ra 180°
 IP 20

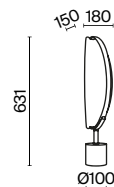

Coctail Time

EN Metal fittings. Shades – gold, pearl gold. Dome lamps – transparent cast glass. Chic design with large edges. Adjustable height. Light source – lamp with G9 base.

DE Metallbeschläge. Farbtöne: Gold, Perlgold. Lampenschirme: Transparentes Gussglas. Eindrucksvolles design mit großen Facetten. Einstellbare Höhe. Lichtquelle: Leuchtmittel mit einer Fassung G9.

IT Armatura metallica. Sfumature: oro, ottone perlato. Plafoniere - vetro colato trasparente. Design spettacolare con bordi larghi. Altezza regolabile. La sorgente luminosa è una lampadina con attacco G9.

FR Armature métallique. Teintes : dorée, dorée perle. Globes en verre coulé transparent. Design impressionnant avec de grands bords. Hauteur réglable. Source de lumière : ampoule à culot G9.

G PG

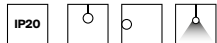

1



2



3



4

1 **MOD325PL-06G1**

⚡ 6 x G9 28 W
IP 20

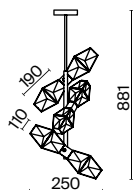

2 **MOD325WL-02G**

⚡ 2 x G9 28 W
IP 20

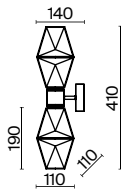

3 **MOD325PL-01G**

⚡ 1 x G9 28 W
IP 20

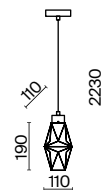

4 **MOD325PL-06G**

⚡ 6 x G9 28 W
IP 20

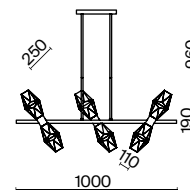



Collar

EN Metal fittings in two colors: gold and chrome. Decorative dome lamps of three types of glass: cast transparent with vertical pattern, blown frosted and pressed smoked glass with geometric pattern. Light source – LED strip, enclosed in an acrylic diffuser.

DE Metallbeschläge in zwei Farbtönen: Gold und Chrom. Drei Arten von dekorativen Lampenschirmen aus Glas: gegossenes transparentes Glas mit vertikalem Muster, geblasenes Milchglas und gestanztes getöntes Glas mit geometrischem Muster. Lichtquelle: Lichtband, eingeschlossen im Acryl-Diffusor.

IT Armatura in metallo in due tonalità: oro e cromo. Plafoniere decorative in vetro di tre tipi: trasparente colato con disegno verticale, soffiato opaco e stampato colorato con disegno geometrico. La sorgente luminosa è una striscia a LED racchiusa in un diffusore in acrilico.

FR Armature en métal en deux teintes : dorée et chrome. Globes décoratifs en verre de trois types : verre coulé transparent avec dessin vertical, verre soufflé mat et verre estampé coloré avec dessin géométrique. Source de lumière : ruban LED intégré dans le diffuseur acrylique.

CH G

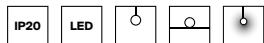

1 **P069PL-L35G3K1**
P069PL-L35CH3K1

LED 35W 1600lm
t° 3000K >80Ra 360°
IP 20

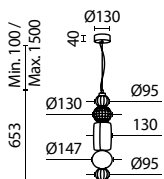

2 **P069PL-L17G3K**
P069PL-L17CH3K

LED 17W 950lm
t° 3000K >80Ra 360°
IP 20

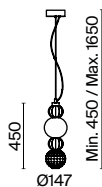

3 **P069PL-L35CH3K**

LED 35W 1550lm
t° 3000K >80Ra 360°
IP 20

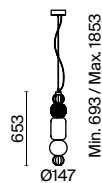

4 **P069PL-L16G3K**

LED 16W 800lm
t° 3000K >80Ra 360°
IP 20

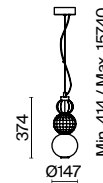



P069PL-L17CH3K

P069PL-035CH3K

Colline

CH

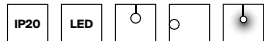

EN Asymmetrical design. Bright-finished glass elements of various heights form a slender colonnade united by a reflector

DE Asymmetrisches Design. Unterschiedlich hohe, glanzpolierte Glaselemente bilden eine harmonische Kolonnade, die durch einen Reflektor verbunden wird.

IT Un disegno asimmetrico. Gli elementi in vetro lucidati di varia altezza compongono un colonnato regolare, riunito da un riflettore

FR Le design asymétrique. Les éléments en verre lustré de la hauteur différente forment une colonnade bien proportionnée, réunie par un réflecteur.



1



2



3

1 **MOD083PL-04CH**

4 x G9 40W
IP 20

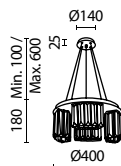

2 **MOD083WL-02CH**

2 x G9 40W
IP 20

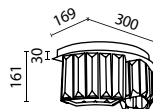

3 **MOD083PL-09CH**

9 x G9 40W
IP 20

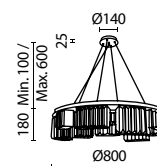



Dallas

B **G** **BS** **CH**

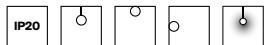

EN Metal fittings in 4 colors: matte black, black, chrome, gold. Dome lamps – blown glass. Colors – smoky, amber, cognac, matte white and black. Design with molecular structure simulation. Height of pendant lamps is adjustable using cable. Lamp with G9 base.

DE Metallbeschläge in 4 Farbtönen: Mattes Schwarz, Schwarz, Chrom, Gold. Lampenschirme: geblasenes Glas. Farbtöne: Rauch, Bernstein, Cognac, Mattes Weiß und Schwarz. Design mit Nachahmung der Molekularstruktur. Durch Seile einstellbare Höhe der Pendelleuchten. Leuchtmittel mit G9-Fassung.

IT Ferramenta in metallo in 4 colori: nero opaco, nero, cromo, oro. Plafoniere - vetro soffiato. Colori: affumicato, ambr, cognac, bianco opaco e nero. Design con imitazione della struttura molecolare. L'altezza delle lampade a sospensione è regolabile con un cavo. Lampadina con attacco G9.

FR Armature métallique en 4 couleurs : noir mat, noir, chrome, dorée. Globes en verre soufflé. Couleurs : fumé, ambr, cognac, blanc mat et noir. Design avec imitation d'une structure moléculaire. Hauteur des suspensions réglable par câble. Ampoule à culot G9.



1 ■ ■ ■ ■ ■



2 ■ ■ ■ ■ ■



3 ■ ■ ■ ■ ■



4 ■ ■ ■ ■ ■

1 ■ **MOD547PL-25B**
 ■ **MOD547PL-25BS**
 ■ **MOD547PL-25CH**
 ■ **MOD547PL-25G**

⚡ 25 x G9 28 W
 IP 20

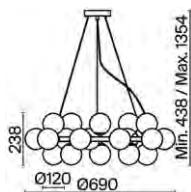

2 ■ **MOD547WL-05B**
 ■ **MOD547WL-05BS**
 ■ **MOD547WL-05CH**
 ■ **MOD547WL-05G**

⚡ 5 x G9 28 W
 IP 20

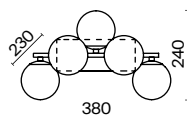

3 ■ **MOD547WL-09B**
 ■ **MOD547WL-09BS**
 ■ **MOD547WL-09CH**
 ■ **MOD547WL-09G**

⚡ 9 x G9 28 W
 IP 20

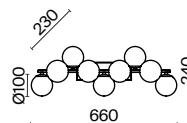

4 ■ **MOD545PL-24B**
 ■ **MOD545PL-24BS**
 ■ **MOD545PL-24CH**
 ■ **MOD545PL-24G**

⚡ 24 x G9 28 W
 IP 20

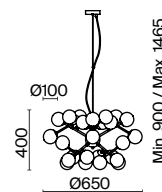



Dallas



5 ■ ■



6 ■ ■



7 ■ ■

5 ■ **MOD545CL-12B**
■ **MOD545CL-12BS**

⦿ 12 × G9 28 W
IP 20

6 ■ **MOD545PL-20CH**
■ **MOD545PL-20G**

⦿ 20 × G9 28 W
IP 20

7 ■ **MOD545PL-12CH**
■ **MOD545PL-12G**

⦿ 12 × G9 28 W
IP 20

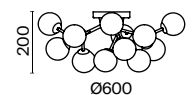
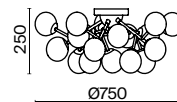
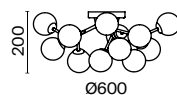





8 



9 





10 

8  **MOD548PL-25CH**
 **MOD548PL-25G**

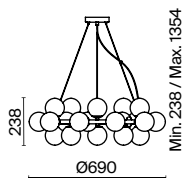

💡 25 x G9 28 W
 IP 20

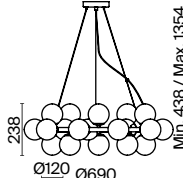

9  **MOD545PL-25B**
 **MOD545PL-25BS**

💡 25 x G9 28 W
 IP 20



10  **MOD545CL-20B**
 **MOD545CL-20BS**

💡 20 x G9 28 W
 IP 20

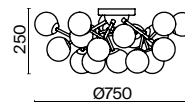

Dallas



11 ■ ■ ■ ■



12 ■ ■ ■ ■



13 ■ ■ ■ ■



14 ■ ■ ■ ■

- 11 ■ MOD545PL-06B
- MOD545PL-06BS
- MOD545PL-06CH
- MOD545PL-06G

⚡ 6 × G9 28 W
IP 20

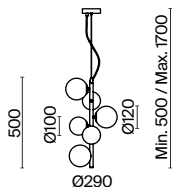

- 12 ■ MOD545PL-11B
- MOD545PL-11BS
- MOD545PL-11CH
- MOD545PL-11G

⚡ 11 × G9 28 W
IP 20

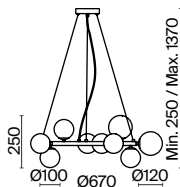

- 13 ■ MOD545WL-03B
- MOD545WL-03BS
- MOD545WL-03CH
- MOD545WL-03G

⚡ 3 × G9 28 W
IP 20

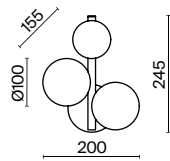

- 14 ■ MOD547WL-13B
- MOD547WL-13BS
- MOD547WL-13CH
- MOD547WL-13G

⚡ 13 × G9 28 W
IP 20

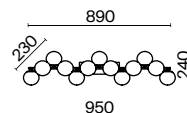



MOD547PL-25G

SPECTACULAR MOMENTS OF LIGHT AVANT- GARDE

The axis of our endeavors hinges on lines and forms—the genesis of innovation. While some might label us as radicals, we persist as pioneers, offering fresh perspectives, unveiling artistic canvases anew, and shaping interiors with a foresight that remains unparalleled.

In this collection, you stay perpetually one step ahead, guided by fixtures inspired by the realms of constructivism and avant-garde art.





- Kazimir P. 112
- The sixth sense P. 114
- Touch P. 116
- Nuance P. 322

Kazimir

G B

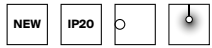

EN Metal fittings, color - black, gold. Glass dome lamp, color - matte white. Compositional techniques of famous vanguard artists embodied in design. Light source - lamp with a G9 base.

DE Beschläge - Metall, Farbe - Schwarz, Gold. Lampenschirm - Glas, Farbe - mattes Weiß. Kompositionstechniken berühmter Avantgardekünstler im Design. Lichtquelle - Leuchtmittel mit G9-Fassung.

IT Armatura-e' in metallo, I colori sono nero, oro. Il paralume è in vetro, il colore è bianco opaco. Tecniche compositive di famosi artisti d'avanguardia nel design. La sorgente dell'illuminazione è una lampadina con un portalampada G9.

FR Armature - métal, couleur - noir, or. Abat-jour - verre, couleur - blanc mat. Techniques de composition d'artistes d'avant-garde célèbres en design. Source de lumière - lama avec culot G9.



1 ■ ■

1 ■ **MOD175WL-01G**
■ **MOD175WL-01B**

💡 1 × G9 40 W
IP 20

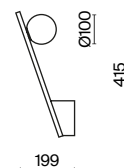



The Sixth Sense

EN Metal fittings of black color. Spherical dome lamps of white glass. LED light source with a color temperature of 3000K. Convenient switches at the top of the fittings. Function of separate switching on of light elements.

DE Metallbeschläge in Schwarz. Kugelförmige Lampenschirme aus weißem Glas. LED-Lichtquelle mit einer Farbtemperatur von 3000K. Praktische Schalter auf der Oberseite der Beschläge. Lichtelemente separat einschaltbar.

IT Armatura in metallo in nero. Plafoniere-sfere di vetro bianco. Sorgente luminosa a LED con temperatura di colore di 3000K. Comodi interruttori nella parte superiore dell'armatura. Funzione di accensione separata di elementi luminosi.

FR Armature métallique de couleur noire. Globes sphériques en verre blanc. Source de lumière LED avec une température de couleur de 3000K. Interrupteurs confortablement placés sur la partie supérieure de l'armature. Fonction d'allumage indépendant des éléments lumineux.

B BS

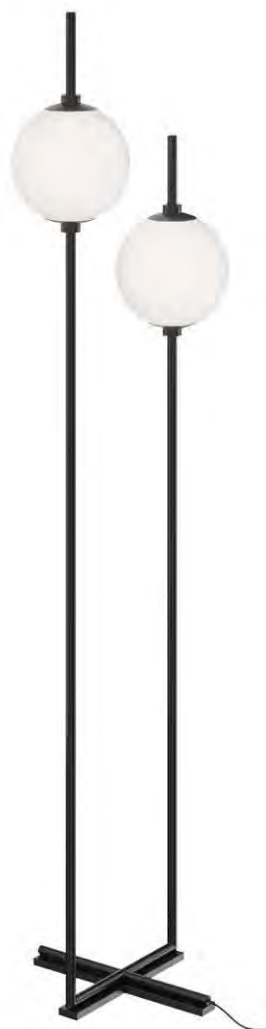
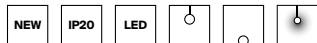

2 ■ ■

1 ■ ■

1 ■ **Z020FL-L12BK**
■ **Z020FL-L12BS3K**

LED 12W 750lm
t° 3000K >80Ra 360°
IP 20

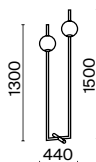

2 ■ **Z020PL-L6B3K**
■ **Z020PL-L6BS3K**

LED 7W 400lm
t° 3000K >80Ra 360°
IP 20

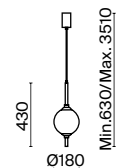



Z020PL-L6BS3K

Z020FL-L12BS3K



reddot award 2022
winner



Touch

B BS

NEW LED IP20

EN Metal fittings, colors: brass, black. Sphere dome lamps made of white matte glass. LED light source, Color temperature: 3000K. A built-in touch-sensitive switch adjusts light intensity stepwise: 25%, 50%, 75% and 100%.

DE Material der Beschläge - Metall, Farben - Messing, Schwarz. Kugelförmige Lampenschirme aus weißem Milchglas. LED-Lichtquelle, Farbtemperatur - 3000K. Eingebauter Schalter reguliert die Helligkeit des Lichtes durch Berühren in Schritten von 25 %, 50 %, 75 % und 100 %.

IT Il materiale dell'armatura è il metallo, i colori sono ottone, nero. I paralumi sono sfere in vetro opaco bianco. Il sorgente luminosa a LED, la temperatura di colore e'3.000 K. L'interruttore incorporato regola la luminosità della luce toccando con incrementi di 25%, 50%, 75% e 100%.

FR Matériau de l'armature - métal, couleurs - laiton, noir. Abat-jour sphériques en verre mat blanc. Source de lumière LED, température de couleur 3000K. L'interrupteur intégré ajuste la luminosité de la lumière au toucher par pas de 25 %, 50 %, 75 % et 100 %.



1 ■ ■

1 ■ **MOD285WL-L10B3K**
 ■ **MOD285WL-L10BS3K**

LED 10 W 900lm
 t° 3000K >80 Ra 360°
 IP 20

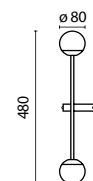



MOD285WL-L10B3K

Drop

G CH

NEW IP20 LED

EN Fittings material - metal, color - gold, chrome. A mix of dome lamps: smooth spheres of cognac or smoky shades + rounded embossed spheres with a diamond-shaped pattern of transparent glass. Adjustable height of pendant models. Max. wire length: 3 meters. LED light source, color temperature - 3000K.

DE Material der Beschläge - Metall, Farben - Gold, Chrom. Lampenschirme Mix: glatte Kugeln in Farbtönen Cognac oder Rauch + abgerundete Reliefkugeln mit rautenförmigem Muster aus transparentem Glas. Höhenverstellbare Pendelmodelle - maximale Kabellänge 3 Meter. LED-Lichtquelle, Farbtemperatur - 3000K.

IT Il materiale dell'armatura è metallo, i colori sono oro, cromo. Mix di tonalità dei paralumi: sfere lisce di tonalità cognac o fumé + rilievo arrotondato con motivo a diamante in vetro trasparente. L'altezza regolabile dei modelli a sospensione è la lunghezza massima del cavo e' di 3 metri. L'illuminazione a LED, la temperatura del colore-e' 3000 K.

FR Le matériau de l'armature est en métal, les couleurs sont doré, chrome. Mélange d'abat-jour : sphères lisses de teinte cognac ou fumée + sphères arrondies en relief avec motif losange en verre transparent. Hauteur réglable des modèles suspendus - longueur maximale du câble 3 mètres. Source de lumière LED, température de couleur 3000K.



- 1 **MOD273PL-L80CH3K**
MOD273PL-L80G3K
- 2 **MOD273PL-L33CH3K**
MOD273PL-L33G3K
- 3 **MOD273CL-L60CH3K**
MOD273CL-L60G3K
- 4 **MOD273PL-L16CH3K**
MOD273PL-L16G3K

LED 80 W 9300lm
t° 3000K >80Ra 120°
IP 20

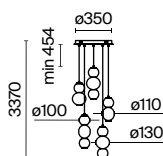

LED 33 W 4000lm
t° 3000K >80Ra 120°
IP 20

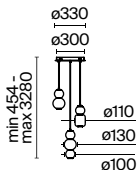

LED 60 W 7000lm
t° 3000K >80Ra 120°
IP 20

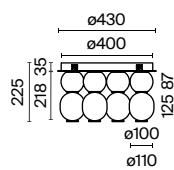

LED 16 W 2000lm
t° 3000K >80Ra 120°
IP 20

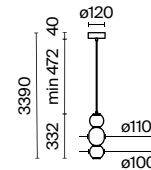



MOD273PL-L80G3K

Duality

G SM BR

NEW IP20

EN Metal base, color - black. Double glass dome lamps. The inner dome lamp is transparent and cone-shaped. The outer dome lamp in three geometric shapes, glass color: mirror gold and mirror chrome, coffee, smoky. Adjustable wire length: 3 meters. Light source - lamp with a E14 base.

DE Sockel aus Metall, Farbe - Schwarz. Lampenschirme aus doppeltem Glas. Innenseite - transparent, kegelförmig. Außenseite - in drei geometrischen Formen, Glasfarbe: Spiegelgold und Chrom, Kaffee, Rauch. Die einstellbare Kabellänge - 3 Meter. Lichtquelle - Leuchtmittel mit E14-Fassung.

IT Base in metallo, il colore è nero. I paralumi sono in doppio vetro. Il paralume interno e' trasparente a forma di cono. Il paralume esterno in tre forme geometriche, il colore del vetro: a specchio, oro e cromo, di caffè, fumoso. La lunghezza del cavo regolabile è di 3 metri. La sorgente dell'illuminazione è una lampadina con un portalampada di E14.

FR Base en métal, couleur - noir. Abat-jour en double verre. L'abat-jour intérieur est transparent en forme de cône. L'abat-jour extérieur est en trois formes géométriques, couleur du verre : doré et chrome de miroir, café, fumé. Longueur de fil réglable - 3 mètres. Source de lumière - lampe avec culot E14.



1



2

1 **MOD271PL-01B4**
MOD271PL-01B5
MOD271PL-01B6

2 **MOD271PL-01B7**
MOD271PL-01B8
MOD271PL-01B9

1 x E27 60 W
 IP 20

1 x E27 60 W
 IP 20

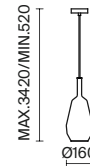
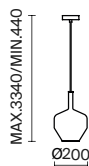

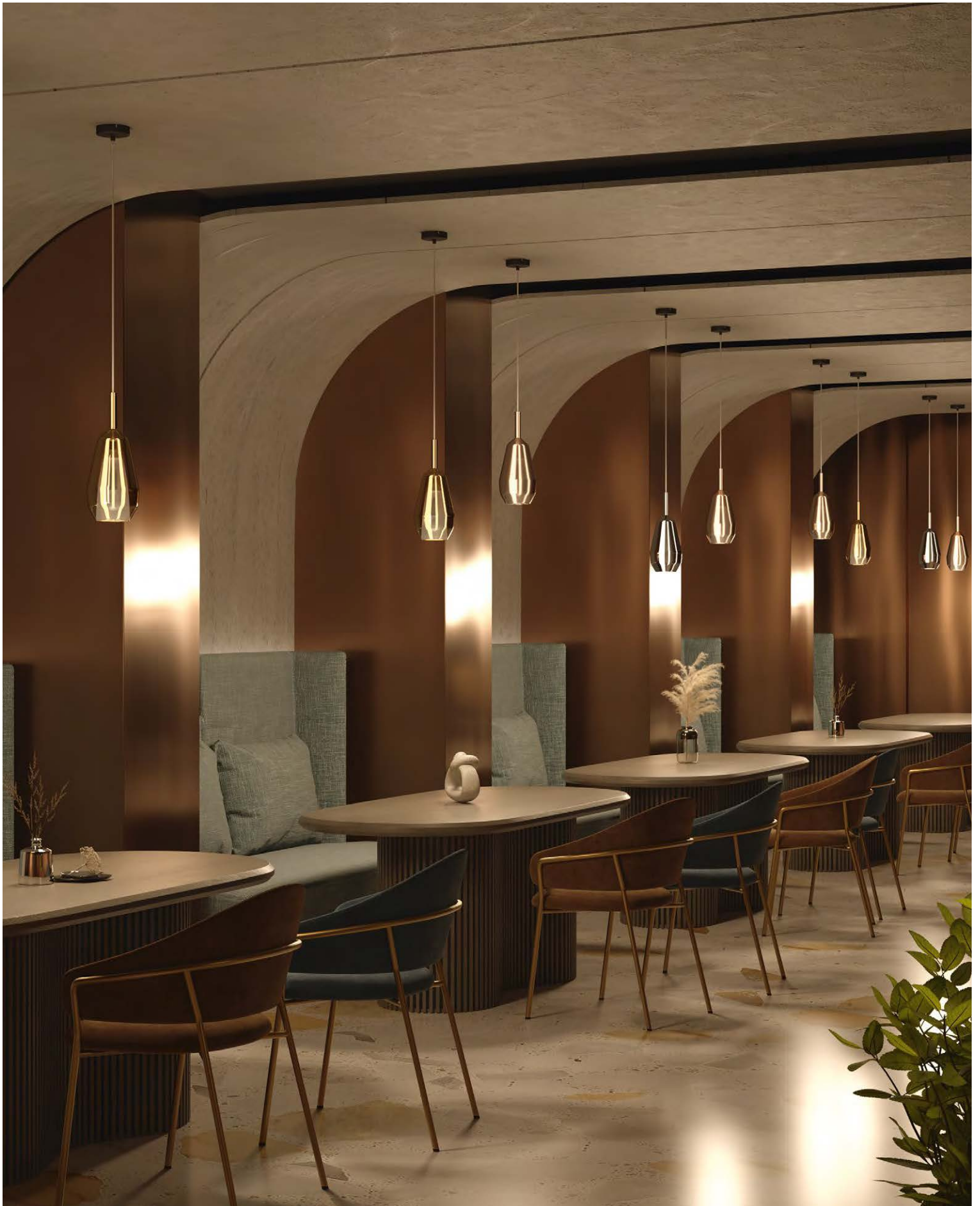



MOD271PL-01B7

MOD271PL-01B9

MOD271PL-01B8

Dynamics

MG MB MW

NEW IP20  



EN Fittings material— aluminum. Powder coating in three colors: matte black, matte white, matte gold. Dome lamp with trendy corrugated texture. Pendant models with external glass elements. Bright key-light.

DE Material der Beschläge: Aluminium. Pulverbeschichtung in drei Farbtönen: Mattes Schwarz, Mattes Weiß, Mattes Gold. Lampenschirm mit einer trendigen, geriffelten Textur. Pendelmodelle mit einem äußeren Glaselement. Helles gerichtetes Licht.

IT Materiale dell'armatura - alluminio. Verniciato a polvere in tre colori: nero opaco, bianco opaco, oro opaco. Plafoniere con trama ondulata alla moda. Modelli a sospensione con elemento esterno in vetro. Luce direzionale vivida.

FR Matériau de l'armature : aluminium. Revêtement par poudre en trois couleurs : noir mat, blanc mat, dorée mat. Globe avec texture ondulée tendance. Modèles de suspensions avec élément en verre extérieur. Lumière orientée vive.



1  **MOD326PL-01MG**
 **MOD326PL-01W**
 **MOD326PL-01B**

 1 x GU10 50 W
 IP 20

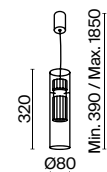

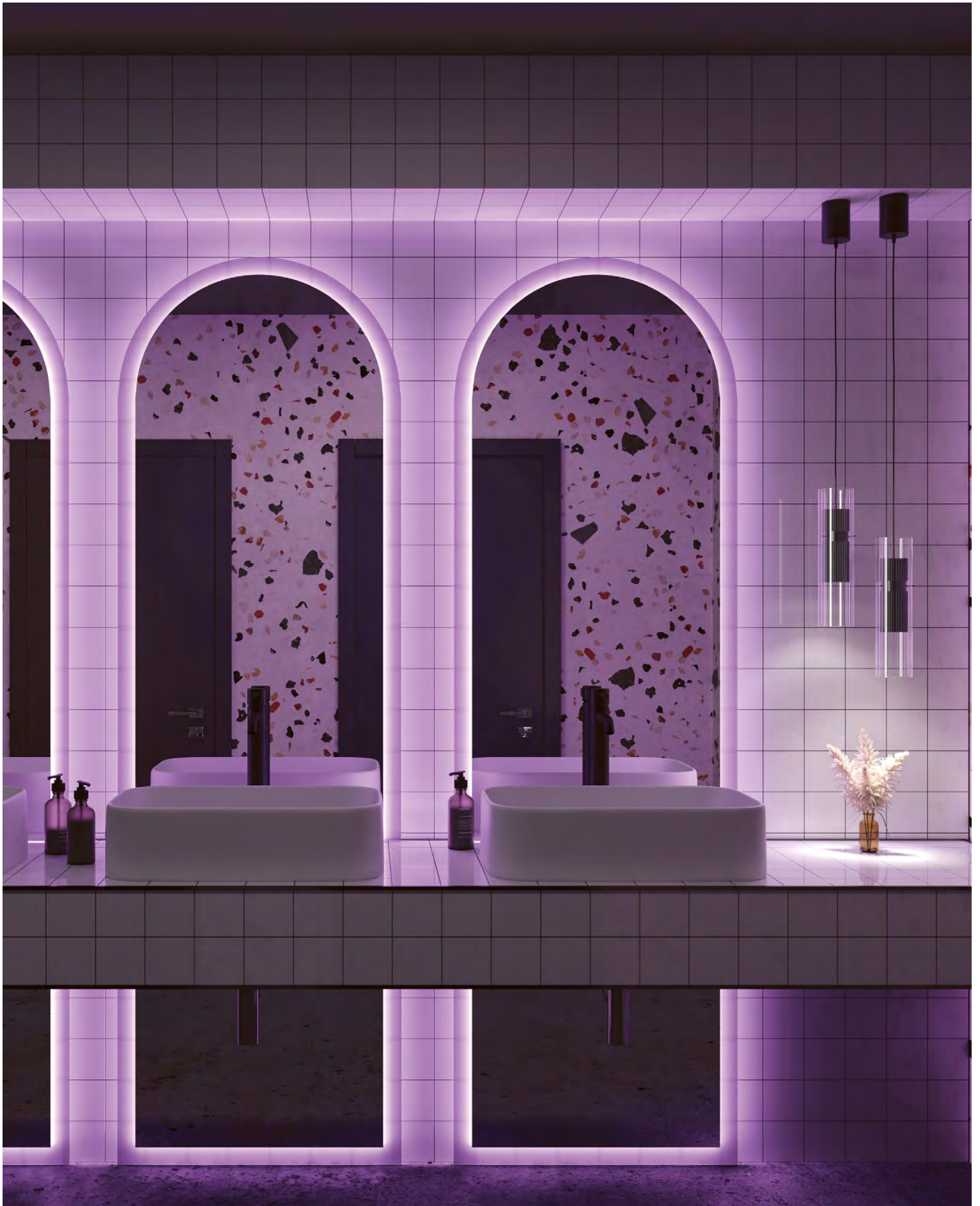

Erich

N G



EN Metal fittings, shades – nickel, brass. Dome lamps – blown glass of white color. Wide range. The floor and table lamps have a dome lamp with adjustable position. Adjustable height.

DE Metallbeschläge, Farbtöne: Nickel, Messing. Lampenschirme: weißes geblasenes Glas. Eine breite Palette. Bei der Stehleuchte und Tischleuchte kann die Position des Lampenschirms geändert werden. Einstellbare Höhe.

IT Armatura in metallo, Plafoniere - nickel, ottone. Le plafoniere sono in vetro soffiato bianco. Famiglia ampia. La posizione delle plafoniere della lampada da terra e della lampada da tavolo è regolabile. Altezza regolabile.

FR Armature métallique, teintes : nickel, laiton. Globes en verre soufflé de couleur blanche. Large assortiment. Possibilité de modifier la position du globe du lampadaire et de la lampe de bureau. Hauteur réglable.



MOD221PL-03BS
MOD221PL-03N

3 x E14 40 W
IP 20

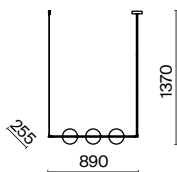

MOD221-PL-05-G
MOD221-PL-05-N

5 x E14 40 W
IP 20

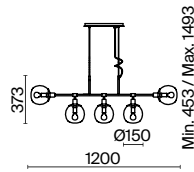

MOD221-WL-01-G
MOD221-WL-01-N

1 x E14 40 W
IP 20

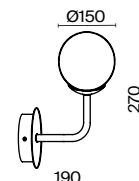



4 



5 



6 

4  **MOD221-PL-12-G**
MOD221-PL-12-N

💡 12 × E14 40W
IP 20

5  **MOD221PL-10G**
MOD221PL-10N

💡 10 × E14 40W
IP 20

6  **MOD221-PL-08-G**
MOD221-PL-08-N

💡 8 × E14 40W
IP 20

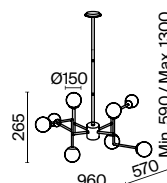
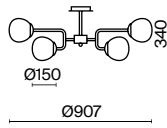
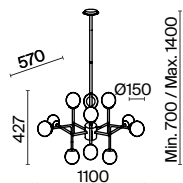

Erich



7

8

9

10

7 **MOD221-FL-01-G**
MOD221-FL-01-N

8 **MOD221-WL-02-G**
MOD221-WL-02-N

9 **MOD221-PL-01-G**
MOD221-PL-01-N

10 **MOD221-TL-01-G**

1 x E14 40W
IP 20

2 x E14 40W
IP 20

1 x E14 40W
IP 20

1 x E14 40W
IP 20

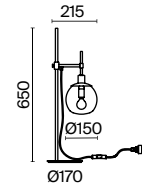
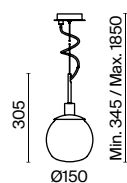
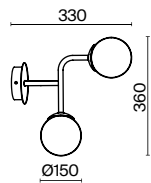
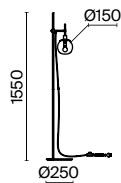



Fermi

G N

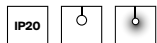

EN Metal fittings in two colors: nickel and gold. Part of dome lamps is made of metal to match the fittings, the other part – of transparent glass. Decorative pendants inside dome lamps. Adjustable height.

DE Metallbeschläge in 2 Farbtönen: Nickel und Gold. Ein Teil des Lampenschirms besteht aus Metall im Farbton der Beschläge, der andere Teil besteht aus transparentem Glas. Dekorative Anhänger im Innern der Lampenschirme. Einstellbare Höhe.

IT Armatura metallica in due tonalità: nichel e oro. Plafoniera parzialmente in metallo in tinta con l'armatura, l'altra parte è in vetro trasparente. Pendenti decorativi all'interno delle plafoniere. Altezza regolabile.

FR Armature en métal en deux teintes : nickel et dorée. Partie du globe réalisée en métal de la teinte de l'armature, l'autre partie transparente. Pendentifs décoratifs à l'intérieur des globes. Hauteur réglable.



1



2



3

P140-PL-170-5-G
 P140-PL-170-5-N

⚡ 5 × E27 60 W
IP 20

P140-PL-170-1-G
 P140-PL-170-1-N

⚡ 1 × E27 60 W
IP 20

P140-PL-110-1-G
 P140-PL-110-1-N

⚡ 1 × E27 60 W
IP 20

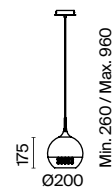
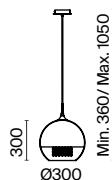
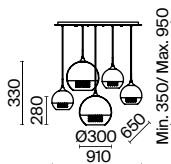



Eustoma

N TR N BL

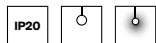

EN Fittings – metal, shade – nickel. Textured dome lamp is made of glass. Dome lamp colors – transparent and blue. Twisted wire. Adjustable height.

DE Metallbeschläge, Farbton: Nickel. Geprägter Lampenschirm aus Glas. Farbtöne des Lampenschirms: transparent und Hellblau. Litzenkabel. Einstellbare Höhe.

IT Armatura - metallo, tonalità - nichel. Plafoniera in rilievo realizzata in vetro. Tonalità della plafoniera: trasparente e blu. Filo a spirale. Altezza regolabile.

FR Armature : métal, teinte : nickel. Globe en verre gaufré. Teintes du globe: transparent et bleu ciel. Fil torsadé. Hauteur réglable.



1 **MOD238-PL-01-TR**
 MOD238-PL-01-BL

💡 1 x E14 40 W
 IP 20

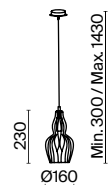

Flusso

BZ

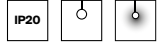

EN Metal fittings in a bronze shade. The spherical dome lamp is of transparent blown glass. Decor - hanging chains inside the ceiling, hidden light source.

DE Metallbeschläge in Bronzeton. Kugelförmiger Lampenschirm: transparentes geblasenes Glas. Dekor: Anhängerketten im Inneren des Lampenschirms. Versteckte Lichtquelle.

IT Armatura metallica in una tonalità bronzo. Plafoniera - sfera è in vetro soffiato trasparente. Decor - catene appese all'interno del soffitto. fonte di luce nascosta.

FR Armature métallique dans une teinte de bronze. Globe sphérique en verre soufflé transparent. Décoration : chaînes suspendues à l'intérieur du globe. Source lumineuse dissimulée.



P095PL-01BZ

P095PL-01BZ1

1 ■ P095PL-01BZ

💡 1 x GU10 12 W
IP 20

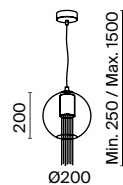

2 ■ P095PL-01BZ1

💡 1 x GU10 12 W
IP 20

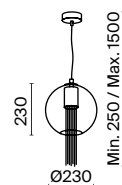

Fortano

BS



EN Metal fittings, shade – brass. Glass dome lamps of white color. Part of the elements are colored in a contrasting black tint. Geometry in design: cylindrical dome lamps, rectangular horns.

DE Metallbeschläge, Farbton: Messing. Lampenschirme aus Glas in Weiß. Ein Teil der Elemente ist in einem kontrastierenden schwarzen Farbton gefärbt. Geometrie im Design: zylindrische Lampenschirme, rechteckige Arme.

IT Armatura in metallo, tonalità - ottone. Plafoniere in vetro bianco. Alcuni degli elementi sono tinti di nero a contrasto. Geometria nel design: Plafoniere cilindriche, luci rettangolari.

FR Armature en métal, teinte : laiton. Globes en verre de couleur blanche. Une partie des éléments est peinte dans une teinte de contraste noire. Géométrie dans le design : globes cylindriques, bras rectangulaires.



MOD089PL-10BS

10 × E27 40 W
IP 20

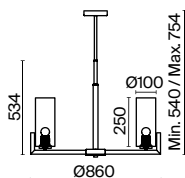

MOD089PL-08BS

8 × E27 40 W
IP 20

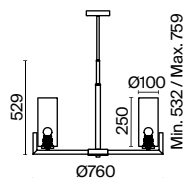

MOD089PL-06BS

6 × E27 40 W
IP 20

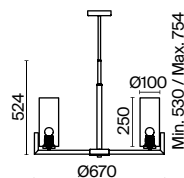

MOD089WL-01BS

1 × E27 40 W
IP 20

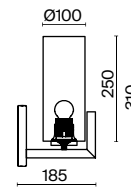



SPECTACULAR MOMENTS OF VISION OF THE FUTURE

We harbor no trepidation regarding the future; rather, we eagerly anticipate its arrival. Modern technology ushers in an era of boundless possibilities and elevated comfort levels. Beneath the veneer of perceived soullessness, our creations pulsate with raw emotion, irresistibly captivating your gaze.

Delve into a world where light fixtures are conceived through the symbiotic fusion of artificial intelligence and the visual analysis of sound waves.



AI collaboration P. 136
Cosmo P. 138
Splash P. 140

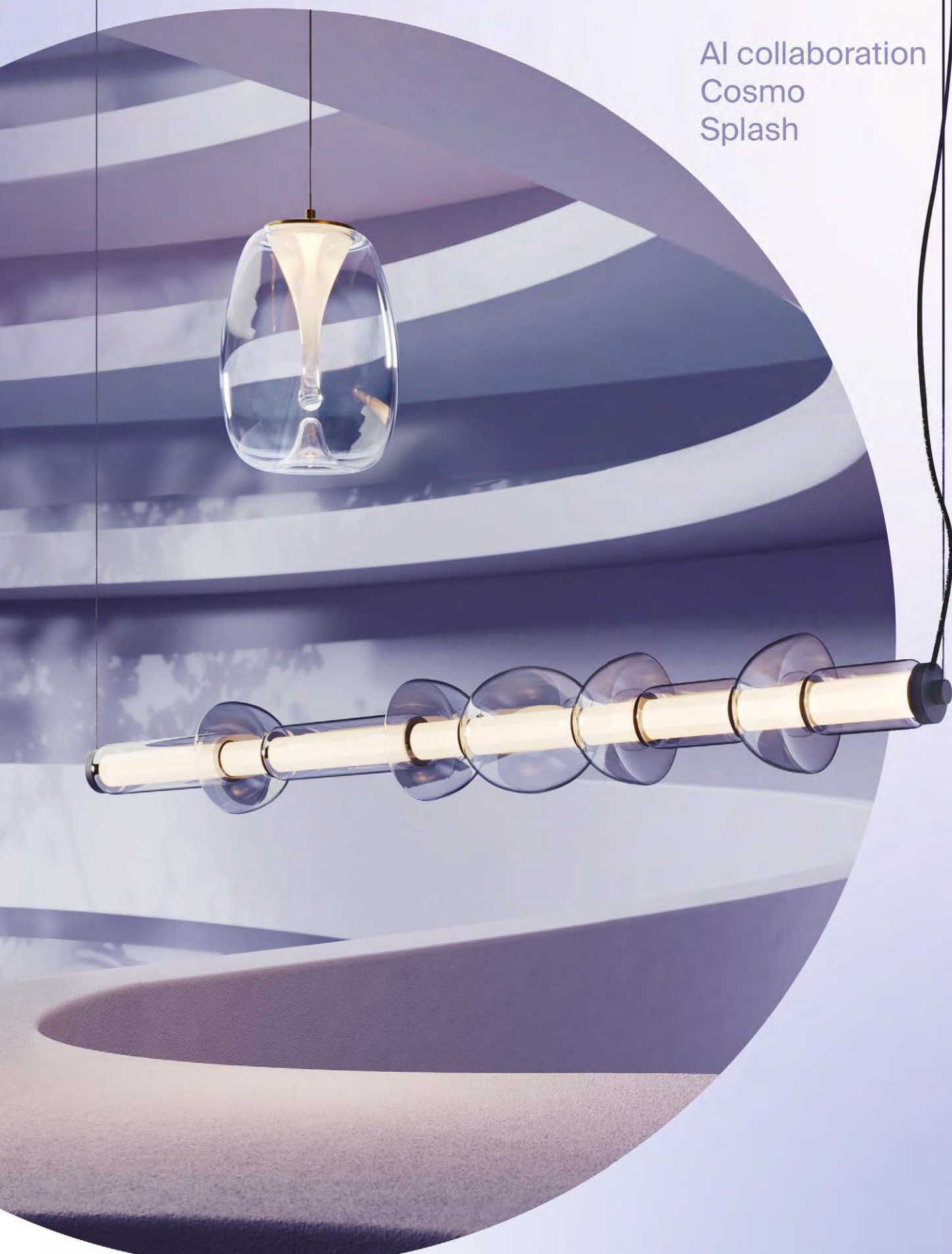

AI Collaboration

B G W

NEW IP20 

EN A portable table lamp. Creative collaboration of artificial intelligence and an object designer. Two options of the lamp housing: a thin metal foot on a flat round base; a glass base with an integrated vase. The dome lamp can be removed from the base to provide for easy maintenance of glass elements and recharging the battery in the dome lamp. Two color options for glass models: transparent and grey. Dome lamps with an acrylic diffuser in 3 colors: black, gold, white. A convenient sensor switch at the dome lamp top. A micro USB charging connector is hidden at the bottom of the dome lamp. LED light source. Color temperature adjustable from 2200K to 4000K.

DE Tragbare Tischleuchte. Das Ergebnis einer kreativen Zusammenarbeit zwischen KI und Objekt designer. Zwei Versionen des Leuchtenrahmens: mit einem dünnen Metallfuß auf einem flachen runden Sockel; mit einem Glassockel mit integrierter Vase. Der Lampenschirm ist von dem Sockel abnehmbar, um die Wartung der Glaselemente und das Aufladen der im Lampenschirm befindlichen Batterie zu erleichtern. Zwei Farboptionen für die Glasmodelle - transparent und Grau. Lampenschirme mit Acryl-Diffusor in 3 Farben: Schwarz, Gold, Weiß. Praktischer Sensorschalter oben am Lampenschirm. Der Micro-USB-Anschluss zum Aufladen ist an der Unterseite des Lampenschirms versteckt. LED-Lichtquelle. Einstellbare Farbtemperatur von 2200K bis 4000K.

IT La lampada da tavolo portatile. Il risultato di una collaborazione creativa tra un'intelligenza artificiale e un designer di soggetti. Le due opzioni per il corpo della lampada: con la gamba sottile in metallo sulla base rotonda piatta; con la base in vetro con vaso integrato. Il paralume viene rimosso dalla base per una comoda cura degli elementi in vetro e la ricarica della batteria situata nella plafoniera. Due opzioni di colore per i modelli in vetro: trasparente e grigio. I paralumi con diffusore in acrilico in 3 colori: nero, oro, bianco. Il comodo interruttore si trova nella parte superiore del paralume. Il connettore micro USB per la ricarica è nascosto nella parte inferiore del paralume. Sorgente luminosa a LED. La temperatura di colore regolabile da 2200K a 4000K.

FR Lampe de table portable. Le résultat d'une collaboration créative entre l'intelligence artificielle et le concepteur objectif. Deux versions du corps de la lampe : avec un pied fin en métal sur une base ronde et plate ; avec base en verre avec vase intégré. L'abat-jour peut être retiré du socle pour faciliter l'entretien des éléments en verre et recharger la batterie située dans l'abat-jour. Deux options de couleurs pour les modèles en verre : transparent et gris. Les abat-jour avec diffuseur acrylique sont présentés en 3 couleurs : noir, doré, blanc. Interrupteur tactile pratique en haut de l'abat-jour. Le connecteur de chargement micro USB est caché au bas de l'abat-jour. Source de lumière LED. Température de couleur réglable de 2200K à 4000K.



1 ■ ■ ■ ■ ■



2 ■ ■ ■ ■ ■

- 1 ■ MOD229TL-L3B3K1
- MOD229TL-L3B3K3
- MOD229TL-L3G3K1
- MOD229TL-L3W3K1

- 2 ■ MOD229TL-L3B3K2
- MOD229TL-L3G3K2
- MOD229TL-L3W3K2

LED 3W 120lm
 t° 3000K >82Ra 120°
 IP 20

LED 3W 120lm
 t° 3000K >82Ra 120°
 IP 20

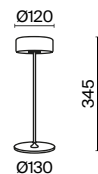
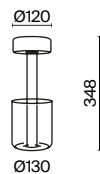



MOD229TL-L3G3K1

Cosmo

B BS

NEW IP20 LED

EN Fittings material - metal, color - black, brass. Dome lamps - transparent glass. 2-in-1 mount: horizontal and vertical. The structure and design are ideal for compositions. Lamp silhouettes are reminiscent of fantastic spaceship images. Light flux: 4800 lm, for basic lighting. LED light source. Color temperature - 3000K.

DE Beschläge - Metall, Farbe - Schwarz, Messing. Lampenschirme - transparentes Glas. 2-in-1-Halterung - horizontal und vertikal. Die Konstruktion und das Design sind ideal zum Kompilieren. Die Silhouetten der Leuchte erinnern an das Bild von fantastischen Raumschiffen. Lichtstrom - 4800 Lm, für die Grundbeleuchtung. LED-Lichtquelle. Farbtemperatur - 3000K.

IT Il materiale dell'armatura è il metallo, i colori sono nero, ottone. I paralumi sono in vetro trasparente. Il fissaggio 2 in 1 è l'orizzontale e il verticale. La costruzione e il design sono ideali per le composizioni. Le sagome della lampada ricordano l'immagine di fantastiche astronavi. Flusso luminoso - 4800 lm, per l'illuminazione principale. L'illuminazione a LED, la temperatura del colore-3000 K.

FR Armature - métal, couleur - noir, laiton. Les abat-jour sont en verre transparent. Fixations 2 en 1 - horizontal et vertical. La construction et le design sont parfaits pour les compositions. Les silhouettes de la lampe rappellent l'image de vaisseaux spatiaux fantastiques. Flux lumineux - 4800 lm, pour l'éclairage principal. Source de lumière LED. Température de couleur - 3000K.

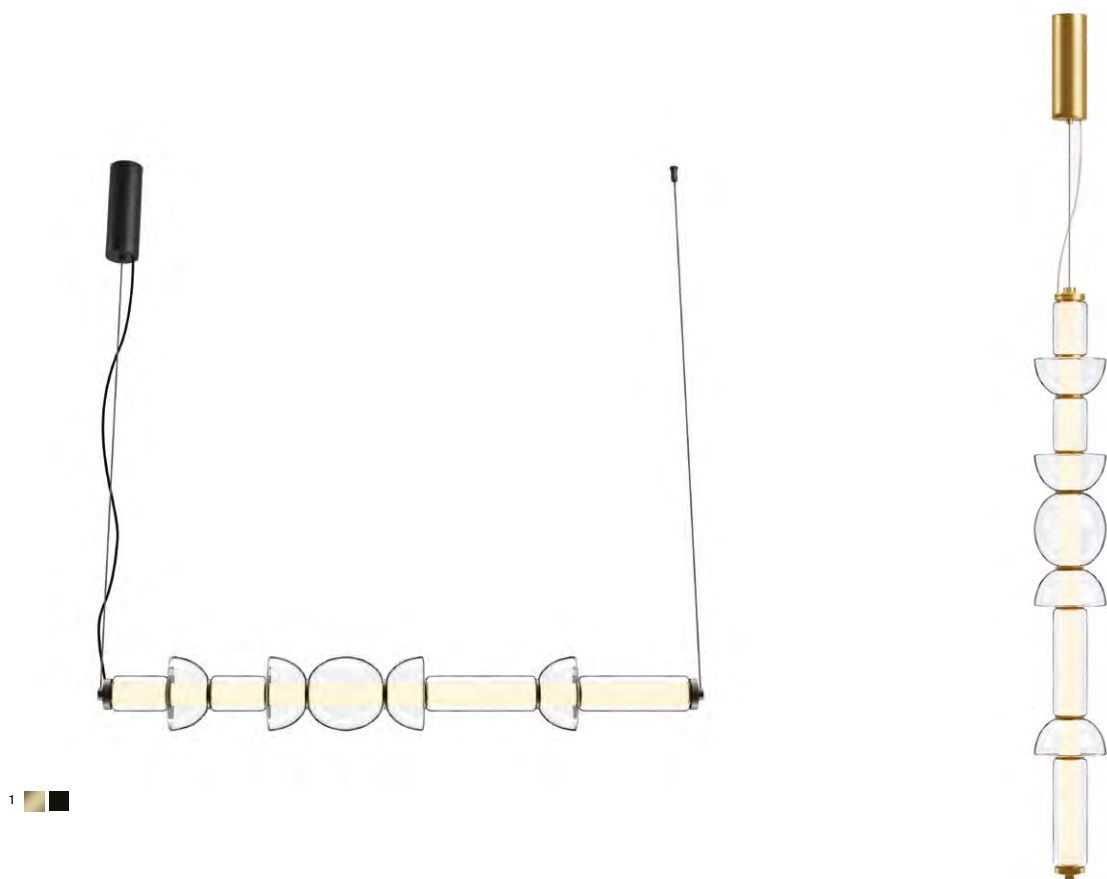

1 ■ **MOD210PL-L39BS3K**
 ■ **MOD210PL-L39B3K**

LED 39W 4800lm
 t° 3000K >80Ra 120°
 IP 20

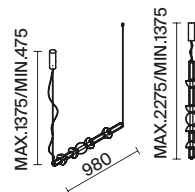



MOD210PL-L39BS3K

Splash

G



EN Metal fittings, color: satin gold. A double glass design of dome lamps, laconic and technologically advanced. Colors of the external dome lamp: transparent and galvanized grey with gradient. LED light source, Color temperature: 3000K. A 3-meter adjustable wire of suspended models, perfect for rooms with high ceilings.

DE Material der Beschläge - Metall, Farbe - satiniertes Gold. Design der Lampenschirme - doppeltes Glas, lakonische und technische Ausführung. Farben des Außenlampenschirms: transparent und verzinktes Grau mit Gradienten. LED-Lichtquelle, Farbtemperatur - 3000K. Verstellbares Kabel von 3m bei Pendelmodellen ist ideal für Räume mit hohen Decken.

IT Il materiale dell'armatura è il metallo, il colore è l'oro satinato. Il design dei paralumi è a doppio vetro, l'esecuzione laconico e tecnologico. I colori del paralume esterno sono grigio trasparente e zincato con un gradiente. La sorgente luminosa a LED, la temperatura di colore è 3000K. Il cavo regolabile da 3 metri dei modelli sospesi è adatto ideale per gli ambienti con soffitti alti.

FR Le matériau de l'armature est en métal, la couleur est or satiné. Le design des abat-jour est en double verre, laconique et technologiquement avancé. Couleurs de l'abat-jour extérieur : transparent, gris galvanisé avec dégradé. Source de lumière LED, température de couleur 3000K. Le fil réglable des modèles suspendus est de 3 mètres, parfait pour les pièces avec de hauts plafonds.



1 ■ **MOD282PL-L8G3K1** 2 ■ **MOD282PL-L8G3K** 3 ■ **MOD282TL-L15G3K** 4 ■ **MOD282TL-L15G3K1**

LED 8W 620lm
t° 3000K >80Ra 360°
IP 20

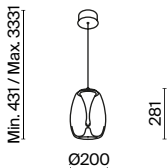

LED 8W 280lm
t° 3000K >80Ra 360°
IP 20

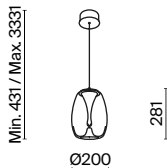

LED 15W 360lm
t° 3000K >80Ra 360°
IP 20

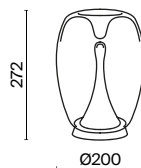

LED 15W 800lm
t° 3000K >80Ra 360°
IP 20

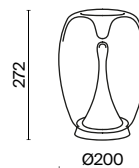



MOS282TL-L15G3K

Gilbert

B

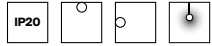

EN Fittings material— metal, color — black. Horns are bent at right angles. Actual industrial style.

DE Material der Beschläge: Metall, Farbton: Schwarz. Arme sind rechteckig gebogen. Aktueller Industrielicht.

IT Materiale dell'armatura - metallo, colore - nero. Le luci sono piegate ad angolo retto. Stile industriale moderno.

FR Matériau de l'armature : métal, couleur : noir. Bras à angle droit. Style industriel en vogue.



1 ■



2 ■



3 ■

1 ■ **T532CL-08B**

💡 8 × E27 60 W
IP 20

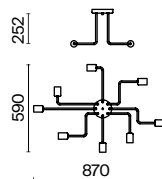

2 ■ **T532WL-02B**

💡 2 × E27 60 W
IP 20

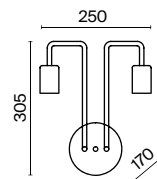

3 ■ **T532CL-12B**

💡 12 × E27 60 W
IP 20

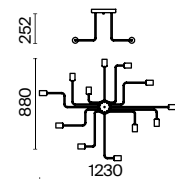



Gioia

CH G

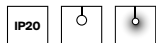

EN Metal fittings in two shades: chrome and gold. Dome lamps of blown glass are plated with the same color as the fittings. A recess in the body of pendant models hides the wire attachment. Wall lamps with image effect. Bidirectional light flux. Light source – lamp with E14 base.

DE Metallbeschläge in 2 Farbtönen: Chrom und Gold. Lampenschirme aus geblasenem Glas, galvanisiert im Farbton der Beschläge. Eine Vertiefung im Rahmen der Pendelmodelle verbirgt die Befestigung des Kabels. Wandleuchten mit Spiegeleffekt. Bidirektionaler Lichtstrom. Lichtquelle: Leuchtmittel mit E14-Fassung.

IT Armatura in metallo in due tonalità: cromo e oro. Plafoniere in vetro soffiato galvanizzate in tinta con l'armatura. Un incavo nel corpo dei modelli a sospensione nasconde l'attacco del filo. Applique con effetto specchio. Flusso luminoso bidirezionale. La sorgente luminosa è una lampadina con attacco E14.

FR Armature métallique en deux teintes : chrome et dorée. Globes en verre soufflé galvanisés dans la teinte de l'armature. Une cavité dans le corps des modèles de suspensions dissimule la fixation du fil. Applique avec effet miroir. Flux lumineux bidirectionnel. Source de lumière : ampoule à culot E14.



1 **P011PL-01CH**
P011PL-01G

1 x E14 40W
 IP 20

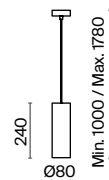



Glassy

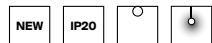

EN Metal base, color - black, gold. Glass hemisphere dome lamp in two colors: glossy smoky black, matte white. Compact height, suitable for small spaces. Light source - lamp with a E27 base.

DE Sockel aus Metall, Farbe - Schwarz, Gold. Halbkugel-Lampenschirm aus Glas in zwei Farben: Rauchschwarz glänzend, mattes Weiß. Kompakte Höhe - geeignet für kleine Räume. Lichtquelle - Leuchtmittel mit E27-Fassung.

IT Base in metallo, i colori sono nero, oro. Il paralume emisfero e' in vetro in due colori: lucido, nero fumoso, bianco opaco. Altezza compatta adatta per piccoli spazi. La sorgente dell'illuminazione è una lampadina con un portalampada di E27.

FR Base en métal, couleur - noir, or. Un abat-jour-hémisphère en verre en deux couleurs : noir fumé brillant, blanc mat. Hauteur compacte - adaptée aux petits espaces. Source de lumière - lampe avec culot E27.



1

1 **MOD270CL-01B**
MOD270CL-01G

💡 1 × E27 60 W
 IP 20

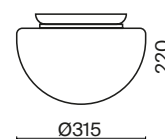



MOD270CL-01B

MOD236PL-L54B3K (p.284)

Tone

BZ

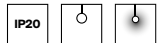

EN Metal fittings, shades – bronze, gold, nickel. Dome lamp of blown glass in amber color. Twisted wire in a textile braiding. Vintage shape of dome lamp.

DE Metallbeschläge, Farbtöne: Bronze, Gold, Nickel. Lampenschirm aus geblasenem Glas in Bernstein. Litzenkabel im Textilgeflecht. Vintage-Form des Lampenschirms.

IT Armatura in metallo, Plafoniere – bronzo, oro, nichel. Plafoniera in vetro soffiato color ambra. Filo a spirale in treccia tessile. Plafoniere stile vintage.

FR Armature en métal, teintes : bronze, dorée, nickel. Globe en verre soufflé de couleur ambre. Fil torsadé dans une tresse textile. Forme du globe vintage.



1 ■



2 ■

1 ■ **P001PL-01BZ**

💡 1 x E27 60 W
IP 20

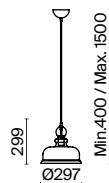

2 ■ **P003PL-01BZ**

💡 1 x E27 60 W
IP 20

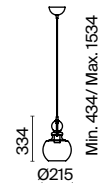



Irving

B
SM **B**
AM

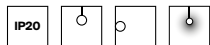

EN Metal fittings in black color. Part of metal elements is plated in brass color. Glass dome lamps in amber and smoky shades. Industrial style. Height of pendant models is adjustable.

DE Metallbeschläge in Schwarz. Ein Teil der metallischen Elemente ist im Farbton Messing galvanisiert. Lampenschirme aus Glas in Bernstein und Rauch in Farbton. Industriestil. Einstellbare Höhe der Pendelmodelle.

IT Armatura in metallo di colore nero. Alcuni degli elementi metallici sono galvanizzati nel colore dell'ottone. Plafoniere di vetro in tonalità ambra e fumé. Stile industriale. L'altezza dei modelli a sospensione è regolabile.

FR Armature en métal de couleur noire. Partie des éléments métalliques galvanisée de couleur laiton. Globes en verre en teintes ambre et fumée. Style industriel. Hauteur des modèles de suspensions réglable.



1 ■



3 ■ ■

■ **T163PL-01R**

■ **T163-01-R**
■ **T163-01-C**

💡 1 x E27 40 W
IP 20

💡 1 x E27 40 W
IP 20

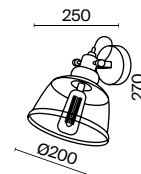



Ligero

BS

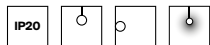

EN Fittings – metal, color – brass. Dome lamps – transparent glass with moiré effect. The height of the pendant lamp is adjustable. Light source – lamp with E27 base.

DE Metallbeschläge, Farbton: Messing. Lampenschirme: Transparentes Glas mit Moiré-Effekt. Einstellbare Höhe der Pendelleuchte. Lichtquelle: Leuchtmittel mit E27-Fassung.

IT Armatura - metallo, colore - ottone. Plafoniere - vetro trasparente con effetto moiré. L'altezza della lampada a sospensione è regolabile. La sorgente luminosa è una lampadina con attacco E27.

FR Armature : métal, couleur : laiton. Globes en verre transparent avec effet moiré. Hauteur de la suspension réglable. Source de lumière : ampoule à culot E27.



1 ■



2 ■

1 ■ **MOD061PL-01BS1**

💡 1 x E27 40 W
IP 20

2 ■ **MOD061WL-01BS**

💡 1 x E27 40 W
IP 20

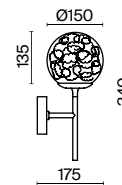
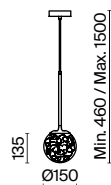

Jackson

B

IP20



EN Fittings – metal, color – black. Decorative caps in brass shade. Industrial style. Height is adjustable using cable.

DE Metallbeschläge in Schwarz. Dekorative Kappen aus Messing. Industriestil. Durch ein Seil einstellbare Höhe.

IT Armatura – metallo, colore - nero. Cappucci decorativi in tonalità ottone. Stile industriale. L'altezza è regolabile con un cavo.

FR Armature : métal, couleur : noir. Capuchons décoratifs de teinte laiton. Style industriel. Hauteur réglable par câble.



T546PL-12B

1 ■ T546PL-12B

💡 12 × E27 7W
IP 20

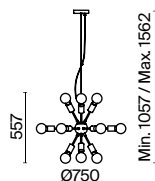

2 ■ T546PL-18B

💡 18 × E27 7W
IP 20

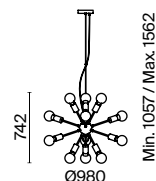

SPECTACULAR MOMENTS OF MODERN ETHNIC CA



Tradition has metamorphosed into a vibrant, contemporary marvel. Our roots serve as a source of pride, and each line bears the weight of a history enriched by the artistry, skill, and toil of countless generations. Every radiance emanating from our fixtures perpetuates this legacy, juxtaposed with the pinnacle of technological advancement.

Here, a synthesis of artisan tradition and modern innovation ushers forth a collection of light fixtures that pulsate with cultural reverence.

- Amulet P. 156
- Maya P. 162
- Golden cage P. 262
- Renaissance P. 328



Amulet

G



EN Metal fittings, color – gold. Accent decorative elements in the form of relief spheres of cast glass. Light source – LED strip – hidden under acrylic diffuser. Height of pendant lamps is adjustable.

DE Metallbeschläge in Gold. Akzentdekor in Form von geprägten Kugeln aus Gussglas. Lichtquelle: LED-Lichtband, verdeckt unter einem Acryl-Diffusor. Pendelleuchten mit einstellbarer Höhe.

IT Armatura in metallo, colore - oro. Decoro d'accento a forma di sfere a rilievo in vetro colato. La sorgente luminosa – striscia a LED – è nascosta sotto un diffusore in acrilico. Le lampade a sospensione hanno altezza regolabile.

FR Armature en métal, couleur : doré. Élément décoratif d'accentuation sous forme de sphères en verre coulé gaufré. Source de lumière : ruban LED dissimulé sous le diffuseur acrylique. Hauteur des suspensions réglable.



1



2

1 **MOD555PL-L11G3K**

LED 16 W 700lm
 t° 3000K >80Ra 360°
 IP 20

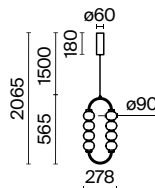

2 **MOD555WL-L11G3K**

LED 16 W 800lm
 t° 3000K >80Ra 360°
 IP 20

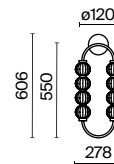



MOD555PL-L35G3K

MOD555CL-L28G3K

MOD555FL-L23G3K



Amulet

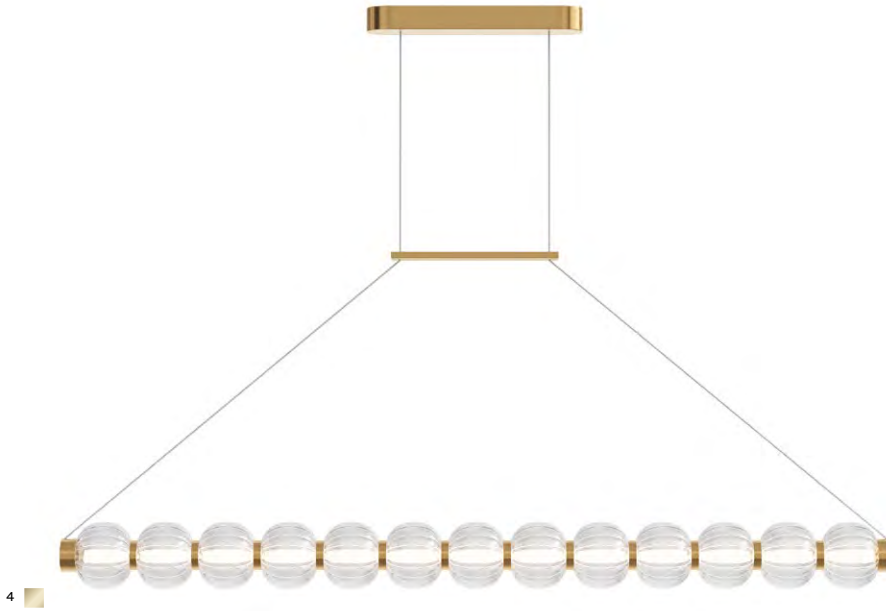

4



5



6



7

4 ■ **MOD555PL-L18G3K**

LED 22 W 1050lm
 t° 3000K >80Ra 360°
 IP 20

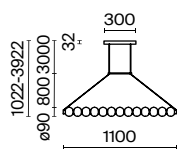

5 ■ **MOD555WL-L13G3K**

LED 19 W 800lm
 t° 3000K >80Ra 360°
 IP 20

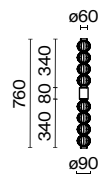

6 ■ **MOD555PL-L35G3K**

LED 40 W 1900lm
 t° 3000K >80Ra 360°
 IP 20

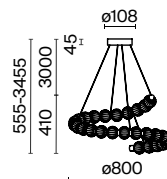

7 ■ **MOD555TL-L8G3K**

LED 10 W 500lm
 t° 3000K >80Ra 360°
 IP 20

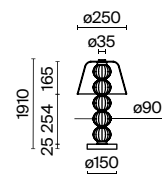



8



9



10



11

8 ■ MOD555CL-L28G3K

LED 36W 2200lm
 t° 3000K >80Ra 360°
 IP 20

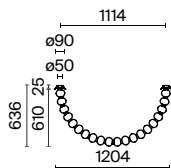

9 ■ MOD555WL-L3G3K

LED 3W 90lm
 t° 3000K >80Ra 360°
 IP 20

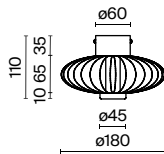

10 ■ MOD555WL-L4G3K

LED 8W 360lm
 t° 3000K >80Ra 360°
 IP 20

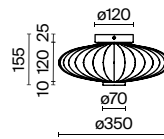

11 ■ MOD555FL-L23G3K

LED 33W 1550lm
 t° 3000K >80Ra 360°
 IP 20

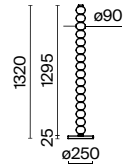

Lunare

BS

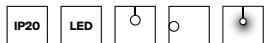

EN Fittings - metal, color - brass. Dome lamp - blown glass with a compact frosted diffuser inside. The effects of light on the outer glass element. Aesthetics of constructivism in design. LED light source. Color temperature is 3000K.

DE Beschläge aus Metall, Farbe: Messing. Lampenschirm aus geblasenem Glas mit einem kompakten, matten Diffusor im Inneren. Lichtspiel auf dem äußeren Glaselement. Die Ästhetik des Konstruktivismus im Design. LED-Lichtquelle. Farbtemperatur 3000K.

IT Armatura - metallo, colore - ottone. Plafoniera - vetro soffiato con all'interno un compatto diffusore opaco. I giochi di luce sull'elemento esterno in vetro. Estetica del costruttivismo nel design. Sorgente luminosa a LED. Temperatura di colore 3000K.

FR Armature en métal, couleur laiton. Globe en verre soufflé avec un diffuseur compact mat à l'intérieur. Jeu de lumière sur l'élément extérieur en verre. Esthétique du constructivisme dans le design. Source de lumière LED. Température de couleur 3000K.



1 ■ MOD327PL-L5BS3K

LED 5W 450lm
t° 3000K >80Ra 120°
IP 20

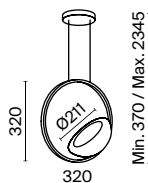

2 ■ MOD327WL-L5BS3K

LED 5W 450lm
t° 3000K >80Ra 120°
IP 20

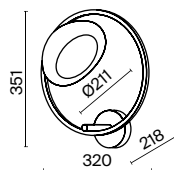

3 ■ MOD327WL-L5BS3K1

LED 5W 450lm
t° 3000K >80Ra 120°
IP 20

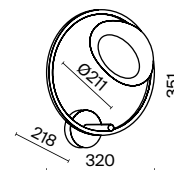

Marble

BS

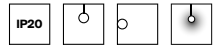

EN Metal fittings. Color – brass. Spherical dome lamps – frosted glass. Marble decoration. Lamps with E27 base are used as light sources.

DE Metallbeschläge. Farbton: Messing. Kugelförmige Lampenschirme: Milchglas. Marmor-Dekor. Als Lichtquellen werden Leuchtmittel mit E27-Fassung verwendet.

IT Armatura metallica. Colore - ottone. Plafoniere-sfera in vetro opaco. Decoro in marmo. Come sorgenti luminose sono utilizzate lampadine con attacco E27.

FR Armature métallique. Couleur : laiton. Globes sphériques en verre mat. Élément décoratif en marbre. Des ampoules à culot E27 sont utilisées comme source de lumière.



1



2



3

1 ■ **MOD187PL-06BS**

⚡ 6 × E27 60 W
IP 20

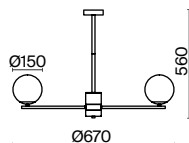
2 ■ **MOD187PL-08BS**

⚡ 8 × E27 60 W
IP 20

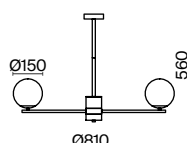
3 ■ **MOD187WL-01BS**

⚡ 1 × E27 60 W
IP 20

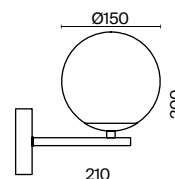

Maya

G

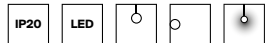

EN Metal fittings of gold color. Decorative elements— textured transparent glass. Design inspired by Meso-american jewelry. LED light source. Color temperature is 3000K.

DE Metallbeschläge in Gold. Dekor: fakturiertes transparentes Glas. Ein Design, das von der Schmuckkunst Mesoamerikas inspiriert ist. LED-Lichtquelle. Farbtemperatur 3000K.

IT Armatura in metallo color oro. Decoro - vetro trasparente strutturato. Design ispirato ai gioielli mesoamericani. Sorgente luminosa a LED. Temperatura di colore 3000K.

FR Armature métallique de couleur dorée. Élément décoratif : verre transparent texturé. Design inspiré de l'art joaillier de Mésoamérique. Source de lumière LED. Température de couleur 3000K.



1



2

1 **P091PL-L18G3K**

LED 10 W 350lm
 t° 3000K >80Ra 120°
 IP 20

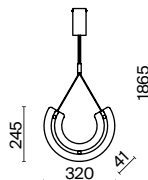

2 **P091WL-L18G3K**

LED 10 W 350lm
 t° 3000K >80Ra 120°
 IP 20

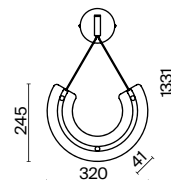



MOD091PL-L18G3K



Mood

BS B

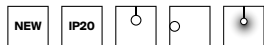

EN Fittings material – metal. Shades – brass, black. The elegant lines of the fittings, transparent glass dome lamps in the form of a ball with miniature lamps create the airy feel of the lamps. Adjustable height of pendant lamps. G4 base.

DE Material der Beschläge - Metall. Farbtöne - Messing, Schwarz. Geschmackvolle Linien der Beschläge, kugelförmige Lampenschirm aus transparentem Glas mit Miniaturlampen schaffen einen Effekt der Luftigkeit der Leuchten. Pendelleuchten mit einstellbarer Höhe. G4-Fassung.

IT Il materiale dell'armatura è il metallo. I colori sono ottone e nero. Le eleganti linee dell'armatura, i paralumi trasparenti in vetro a forma di palla con le piccole lampade creano l'effetto dell'ariosità delle lampade. Le lampade a sospensione sono regolabili in altezza. Il portalamпада e' G4.

FR Matériel de l'armature - métal. Couleur - laiton, noir. Lignes gracieuses de l'armature, abat-jour en verre transparents sous forme de boule avec lampes miniatures créent l'effet de légèreté des lampes. Lampes à suspension réglables en hauteur. Culot G4.

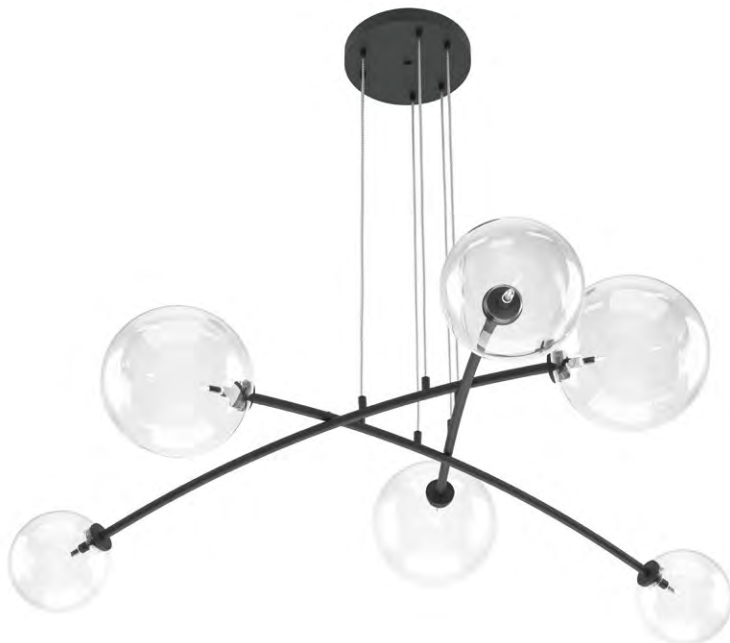

1 ■ ■



3 ■ ■



2 ■ ■

1 ■ **MOD172PL-06B**
■ **MOD172PL-06BS**

⚡ 6 x G4 20 W
IP 20

2 ■ **MOD172PL-01B**
■ **MOD172PL-01BS**

⚡ 1 x G4 20 W
IP 20

3 ■ **MOD172WL-01B**
■ **MOD172WL-01BS**

⚡ 1 x G4 20 W
IP 20

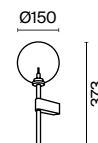
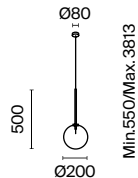
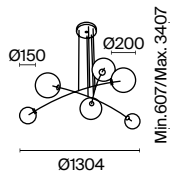



MOD172PL-01BS

MOD172PL-06BS

Muse

G CH





EN Metal base completed with sculptural cast glass in two shades: smoky and transparent. Cotton lampshade of white color. Light source – lamp with E27 base.

DE Der Metallsockel ist durch skulpturales Gussglas in zwei Farbtönen ergänzt: rauchig und transparent. Lampenschirm aus Baumwolle in Weiß. Lichtquelle: Leuchtmittel mit E27-Fassung.

IT Il piede in metallo è completato da uno scultoreo vetro colato in due tonalità: fumé e trasparente. Paralume in cotone bianco. La sorgente luminosa è una lampadina con attacco E27.

FR Base métallique complétée par un verre coulé sculpté en deux teintes : fumé et transparent. Abat-jour en coton de couleur blanche. Source de lumière : ampoule à culot E27.



1  **MOD304TL-01G**
 **MOD304TL-01CH**

1 × E27 60 W
 IP 20

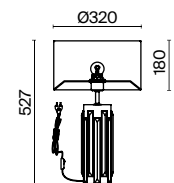



MOD304TL-01CH

Rueca

B BS

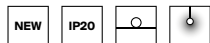

EN Metal fittings, color - brass, black. A transparent glass dome lamp with an embossed pattern and a hidden light source creates the illusion of a lamp inside. A convenient switch on top of the lamp rod. LED light source, color temperature - 3000K.

DE Material der Beschläge - Metall, Farbe - Messing, Schwarz. Lampenschirm aus transparentem Glas mit reliefartigen Ornamenten und versteckter Lichtquelle erzeugt die Illusion einer Lampe im Inneren. Praktischer Schalter oben am Leuchtenstab. LED-Lichtquelle, Farbtemperatur - 3000K.

IT Il materiale dell'armatura è metallo, i colori sono ottone, nero. Il paralume in vetro trasparente con ornamenti in rilievo e con una fonte di luce nascosta crea un'illusione lampade all'interno. Il comodo interruttore si trova sulla parte superiore dell'asta della lampada. Sorgente luminosa a LED, la temperatura di colore e' 3000K.

FR Armature métallique, couleur - noir, blanc. Abat-jour-boule soufflé en verre à base cylindrique allongée en trois couleurs : noir fumé, blanc brumeux, beige cognac. Source de lumière LED à la base de l'abat-jour. Température de couleur 3000K. Deux diamètres d'abat-jour et longueur de fils réglables pour créer des compositions diverses.



1 ■



2 ■

1 ■ **P060TL-L12BK**

LED 8 W 100lm
t° 3000K >80Ra 120°
IP 20

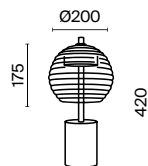

2 ■ **P060TL-L12BSK1**

LED 8 W 100lm
t° 3000K >80Ra 120°
IP 20

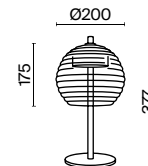



P060TL-L12BK

Nostalgia

MG

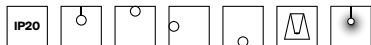

EN Metal fittings of matte gold color. Spherical dome lamps of frosted blown glass. Fashionable asymmetry in design. Light source – lamps with E14 base.

DE Metallbeschläge in mattem Gold. Kugelförmige Lampenschirme aus geblasenem Milchglas. Trendige Asymmetrie im Design. Lichtquelle: Leuchtmittel mit E14-Fassung.

IT Armatura in metallo colore oro opaco. Plafoniere a sfera in vetro soffiato opaco. Asimmetria alla moda nel design. Sorgente luminosa - lampadine con attacco E14.

FR Armature en métal de couleur dorée mat. Globes sphériques en verre soufflé mat. Design asymétrique tendance. Source de lumière : ampoules à culot E14.



1

2

3

1 **MOD048FL-03G**

3 x E14 40 W
IP 20

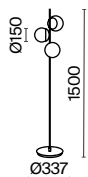

2 **MOD048PL-03G**

3 x E14 40 W
IP 20

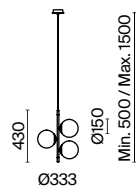

3 **MOD048WL-01G**

1 x E14 40 W
IP 20

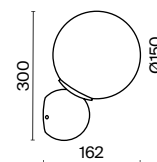



4 ■



5 ■



6 ■

4 ■ **MOD048CL-06G**

💡 6 × E14 40 W
IP 20

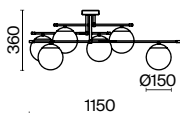

5 ■ **MOD048WL-02G**

💡 2 × E14 40 W
IP 20

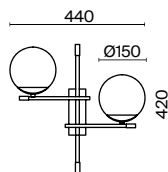

6 ■ **MOD050WL-02G**

💡 2 × E14 40 W
IP 20

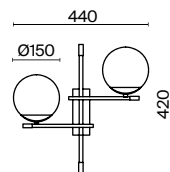

Nostalgia



7 ■ **MOD048PL-09G**

💡 9 × E14 40 W
IP 20

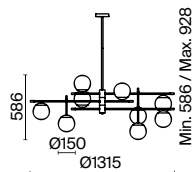

8 ■ **MOD048PL-06G**

💡 6 × E14 40 W
IP 20

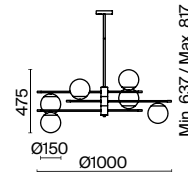

9 ■ **MOD048PL-02G**

💡 2 × E14 40 W
IP 20

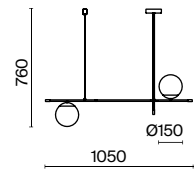



Ordo

B BS CH

NEW LED IP20

EN Metal fittings, color - chrome, brass, black. Cylindrical glass dome lamps with a vertical embossed pattern in three shades: transparent, cognac, smoky. A metaphor of ancient Greek temple columns in lamps. LED light source. Color temperature - 3000K.

DE Beschläge - Metall, Farbe - Chrom, Messing, Schwarz. Zylindrische Lampenschirme aus Glas mit vertikalem Reliefmuster in drei Farbtönen: transparent, Cognac, Rauch. Eine Metapher der antiken griechischen Tempelsäulen in Form von Leuchten. LED-Lichtquelle. Farbtemperatur 3000K.

IT L'armatura è in metallo, i colori sono cromo, ottone, nero. Paralumi cilindrici in vetro con motivo verticale in rilievo in tre tonalità: trasparente, cognac, fumoso. Metafora delle antiche colonne del tempio greco sotto forma di lampade. Sorgente luminosa a LED. La temperatura di colore è 3000K.

FR Armature - métal, couleur - chrome, laiton, noir. Abat-jour en verre cylindrique avec un motif en relief vertical en trois teintes : transparent, cognac, fumé. Métaphore des colonnes des temples grecs antiques sous forme de lampes. Source de lumière LED. Température de couleur 3000K.



1 ■ ■ ■



2 ■ ■ ■

1 ■ **MOD272PL-L12B3K**
 ■ **MOD272PL-L12BS3K**
 ■ **MOD272PL-L12CH3K**

2 ■ **MOD272PL-L12B3K1**
 ■ **MOD272PL-L12BS3K1**
 ■ **MOD272PL-L12CH3K1**

LED 12W 1600lm
 t° 3000K >80Ra 120°
 IP 20

LED 12W 1600lm
 t° 3000K >80Ra 120°
 IP 20

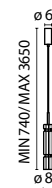



MOD272PL-L12CH3K

MOD272PL-12CH3K1

Rebel

G CH

LED IP20

EN Metal fittings in two colors: chrome and black. Dome lamp of frosted glass. External glass decorative elements in smoky and amber color. Trend – optical illusion, luminous element floating effect. LED light source. Color temperature is 3000K.

DE Metallbeschläge in 2 Farbtönen: Chrom und Schwarz. Lampenschirm aus Milchglas. Äußerer Glasdekor in Farbtönen Rauch und Bernstein. Trend: eine optische Täuschung, Effekt eines schwebenden Lichtelements. LED-Lichtquelle. Farbtemperatur 3000K.

IT Armatura in metallo in due tonalità: cromo e nero. Plafoniera in vetro opaco. Decoro esterno in vetro affumicato e ambra. Tendenza – illusione ottica, effetto di sospensione dell'elemento luminoso. Sorgente luminosa a LED. Temperatura di colore 3000K.

FR Armature métallique en deux teintes : chrome et noir. Globe en verre mat. Élément décoratif extérieur de couleur fumée et ambre. Tendance : illusion d'optique, effet de lévitation de l'élément éclairant. Source de lumière LED. Température de couleur 3000K.



1

1 **MOD322PL-L6B3K**
MOD322PL-L6G3K

LED 6W 500lm
 t° 3000K >80Ra 360°
 IP 20

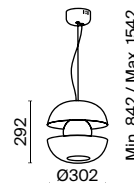



MOD322PL-L6B3K

Reels

G B

NEW IP20

EN Metal fittings, color - black, gold. Dynamic round dome lamps with a spiral relief. Material of dome lamps - glass, colors - matte white, glossy smoky. Light source - lamps with a E14, E27 base.

DE Material der Beschläge - Metall, Farben - Schwarz, Gold. "Dynamische" runde Lampenschirme mit spiralförmigem Relief. Material der Lampenschirme - Glas, Farben - mattes Weiß, Rauch glänzend. Lichtquelle - Leuchtmittel mit E14, E27-Fassung.

IT Il materiale dell'armatura è metallo, i colori sono nero, oro. I paralumi rotondi "dinamichi" con rilievo a spirale. Il materiale dei paralumi è vetro, i colori sono bianchi opachi, fumosi lucidi. La sorgente dell'illuminazione sono le lampadine con portalampade E14, E27.

FR Matériau de l'armature - métal, couleurs - noir, doré. Abat-jour ronds "dynamiques" avec un relief en spirale. Le matériau des abat-jour est le verre, les couleurs sont blanc mat, fumé brillant. Source de lumière - lampes avec culot E14, E27.



1 ■ ■



2 ■ ■



1 ■ **MOD268CL-01B**
■ **MOD268CL-01G**

⚡ 1 x E27 60 W
IP 20

2 ■ **MOD268CL-03B**
■ **MOD268CL-03G**

⚡ 3 x E14 40 W
IP 20

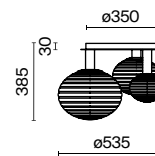
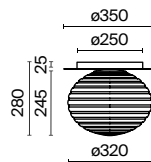

Nebula

EN Metal fittings, color - black, white. A blown glass spheric dome lamp with an elongated cylindrical base in three colors: smoky black, misty white, beige cognac. LED light source at the dome lamp base. Color temperature - 3000K. Two dome lamp diameters and adjustable wire length for a variety of compositions.

DE Metallbeschläge, Farbe - Schwarz, Weiß. Geblasener Kugel-Lampenschirm aus Glas mit langgestrecktem zylindrischem Sockel in drei Farben: Rauchschar, Nebelweiß, Beige/Cognac. LED-Lichtquelle im Sockel des Lampenschirms. Farbtemperatur 3000K. Zwei Lampenschirmdurchmesser und einstellbare Kabellänge ermöglichen, eine Vielzahl von Kompositionen zu gestalten.

IT L'armatura è in metallo, i colori sono nero, bianco. Il paralume soffiato e' una palla di vetro con una base cilindrica allungata in tre colori: nero fumoso, bianco nebbioso, beige-cognac. LED-sorgente luminosa alla base del paralume. La temperatura del colore e' 3000K. Due diametri dei paralumi e la lunghezza regolabile dei cavi per creare una varietà di composizioni.

FR Armature métallique, couleur - noir, blanc. Abat-jour-boule soufflé en verre à base cylindrique allongée en trois couleurs: noir fumé, blanc brumeux, beige cognac. Source de lumière LED à la base de l'abat-jour. Température de couleur 3000K. Deux diamètres d'abat-jour et longueur de fils réglables pour créer des compositions diverses.



1 ■ **MOD182PL-L4B3K**
□ **MOD182PL-L4W3K**

LED 4W 400lm
t° 3000K >80Ra 120°
IP 20

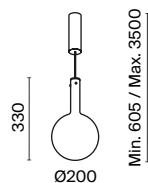

2 ■ **MOD182PL-L6B3K**
□ **MOD182PL-L6W3K**

LED 6W 700lm
t° 3000K >80Ra 120°
IP 20

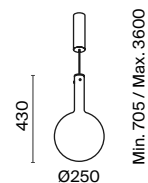

Rendez-vous

BS

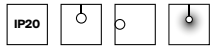

EN Metal fittings of brass color. Spherical dome lamps of frosted white glass. Trend streamlined forms. Retro style design. Light source – lamps with E14 base.

DE Metallbeschläge in Messing. Kugelförmige Lampenschirme aus weißem Milchglas. Trendige Stromlinienformen. Design im Retro-Stil. Lichtquelle: Leuchtmittel mit E14-Fassung.

IT Armatura in metallo verniciato in color ottone. Plafoniere-sfere di vetro bianco opaco. Forme aerodinamiche alla moda. Design in stile retrò. Sorgente luminosa - lampadine con attacco E14.

FR Armature en métal peint de couleur laiton. Globes sphériques en verre blanc mat. Formes épurées tendance. Design dans le style rétro. Source de lumière : ampoules à culot E14.



1



2



3

1 ■ **MOD109PL-08BS**

💡 8 × E14 40 W
IP 20

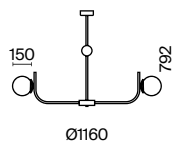

2 ■ **MOD109WL-01BS**

💡 1 × E14 40 W
IP 20

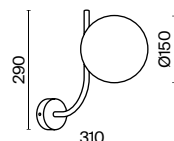

3 ■ **MOD109PL-10BS**

💡 10 × E14 40 W
IP 20

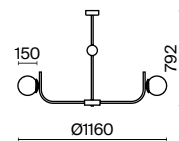



MOD109WL-01BS

MOD109PL-08BS

Ring



EN Metal fittings in three shades: white, black, brass. Spherical dome lamps are fixed on rounded metal frame. Dome lamp material – blown glass, color – white. Height of pendant models is adjustable.

DE Metallbeschläge in drei Farbtönen: Weiß, Schwarz, Messing. Kugelförmige Lampenschirme sind auf einem runden Metallrahmen befestigt. Material der Lampenschirme: geblasenes Glas, Farbton: Weiß. Einstellbare Höhe der Pendelmodelle.

IT Armatura in metallo in tre tonalità: bianco, nero, ottone. Le plafoniere-sfere sono fissate su una struttura metallica arrotondata. Materiale delle plafoniere - vetro soffiato, colore - bianco. L'altezza dei modelli a sospensione è regolabile.

FR Armature en métal en trois teintes : blanc, noir, laiton. Globes sphériques fixés sur une carcasse métallique ronde. Matériau des globes : verre soufflé, couleur : blanc. Hauteur des modèles de suspensions réglable.

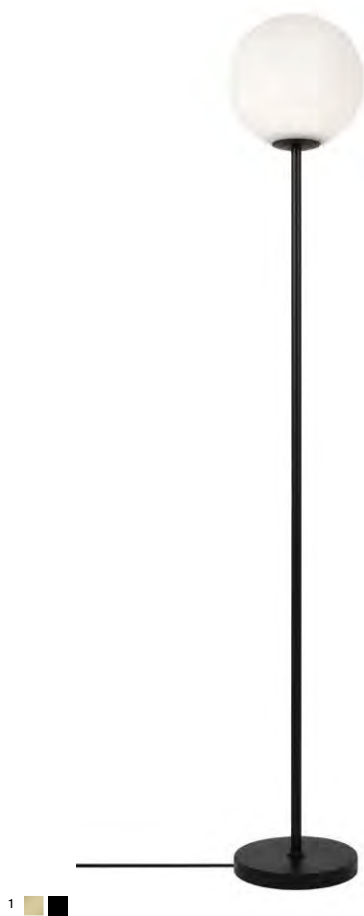

1 **MOD013FL-01BS**
MOD013FL-01B

2 **MOD013PL-02BS1**
MOD013PL-02B
MOD013PL-02W

💡 1 x E27 60 W
 IP 20

💡 2 x G9 25 W
 IP 20

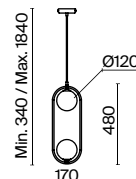
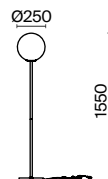



MOD013FL-01BS

Ring



3 ■ ■ ■



4 ■ ■ ■

3 ■ **MOD013PL-06BS1**
 ■ **MOD013PL-06B**
 ■ **MOD013PL-06W**

4 ■ **MOD013PL-04BS1**
 ■ **MOD013PL-04B**
 ■ **MOD013PL-04W**

⚡ 6 × G9 25 W
 IP 20

⚡ 4 × G9 25 W
 IP 20

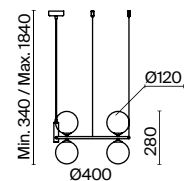
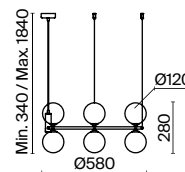

Pattern

CH G

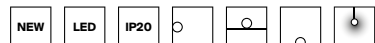

EN Metal fittings, color - gold, chrome. A mix of round and elongated dome lamps made of white matte and transparent glass with a reticulate and linear motif. LED light source, color temperature - 3000K.

DE Metallbeschläge, Farbe - Gold, Chrom. Eine Mischung aus abgerundeten und langgestreckten Lampenschirmen aus dem weißen matten und transparenten Glas mit Maschen- und linearem, sich wiederholendem Reliefmustern. LED-Lichtquelle, Farbtemperatur - 3000K.

IT L'armatura è in metallo, i colori sono oro, cromo. Un mix di paralumi di forme arrotondate e allungate in vetro bianco opaco e trasparente con motivo reticolare e lineare ripetuto in rilievo. Sorgente luminosa a LED, la temperatura di colore è 3000K.

FR Armature métallique, couleur - doré, chrome. Un mélange d'abat-jour de formes rondes et allongées en verre blanc mat et transparent avec des motifs en relief maillés linéaires répétitifs. Source de lumière LED, température de couleur 3000K.



1 **MOD267WL-L18CH3K**
MOD267WL-L18G3K

LED 18 W 2400lm
t° 3000K >80Ra 120°
IP 20

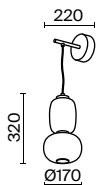

2 **MOD267TL-L28CH3K**
MOD267TL-L28G3K

LED 28 W 3800lm
t° 3000K >80Ra 120°
IP 20

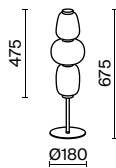

3 **MOD267FL-L32CH3K**
MOD267FL-L32G3K

LED 32 W 4500lm
t° 3000K >80Ra 120°
IP 20

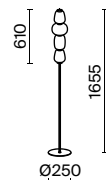

SPECTACULAR MOMENTS OF ASPIRATIONS OF NATURE





Frozen

BS

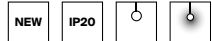

EN Fittings material - metal, color - brass. This series is inspired by the aesthetics of northern forests. Dome lamps are made of solid cast glass with a wood cut shape and texture. Three color options of dome lamps: transparent; transparent + matte; transparent + matte + pastel green. Aesthetic fastenings and a magnetic ceiling bowl with no visible screws. Ready-made compositions of 1, 5, 7 and 12 dome lamps. Light source - lamp with a G4 base.

DE Material der Beschläge - Metall, Farbe - Messing. Die Serie ist von der Ästhetik der nördlichen Wälder inspiriert. Lampenschirme - Guss-Ganzglas in Form und Textur eines Holzschnitts. Drei Farboptionen der Lampenschirme: transparent; transparent + matt; transparent + matt + pastellgrün. Ästhetische Halterungen und magnetische Deckenschale ohne sichtbare Schrauben. Fertige Kompositionen aus 1, 5, 7 und 12 Lampenschirmen. Lichtquelle - Leuchtmittel mit G4-Fassung.

IT Il materiale dell'armatura è il metallo, il colore è ottone. La serie è ispirata all'estetica delle foreste settentrionali. I paralumi sono in vetro massiccio fuso nella forma e nella trama di un taglio di legno. Tre opzioni di colore per le tonalità dei paralumi: trasparente, trasparente + opaco, trasparente + opaco + verde pastello.

FR Le matériau de fixation est le métal, la couleur est laiton. La série s'inspire de l'esthétique des forêts du nord. Les abat-jour sont en verre massif moulé ayant la forme et la texture d'une coupe de bois. Trois options de couleurs des abat-jour : transparent ; transparent + mat ; transparent + mat + vert pastel. Fixations esthétiques et cuvette de plafond magnétique sans boulons visibles. Compositions finies de 1, 5, 7 et 12 abat-jour. Source de lumière - lampe avec culot G4.



1



2



3



4

1 ■ **MOD254PL-05BS**

⚡ 5 x G4 28 W
IP 20

2 ■ **MOD254PL-01BS**

⚡ 1 x G4 28 W
IP 20

3 ■ **MOD254PL-07BS**

⚡ 7 x G4 28 W
IP 20

4 ■ **MOD254PL-12BS**

⚡ 12 x G4 28 W
IP 20

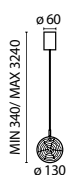



Miracle

BS

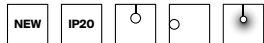

EN Metal fittings, brass color. Dome lamps-inflorescences made of cast glass in smooth shapes. Spectacular light reflections on the smooth reliefs of the dome lamp. Light source - lamp with a G9 base.

DE Metallbeschläge, Farbe - Messing. Lampenschirme-Blumen aus Gussglas in fließenden Formen. Eindrucksvolle Lichtreflexe auf den glatten Reliefs des Lampenschirm. Lichtquelle - Leuchtmittel mit G9-Fassung.

IT L'armatura è in metallo, il colore è in ottone. I paralumi sono-infiorescenze di vetro fuso in forme fluide. Spettacolari riflessi di luce sui rilievi lisci di un paralume. La sorgente dell'illuminazione è una lampadina con un portalampada G9.

FR L'armature est en métal, la couleur est laiton. Les abat-jour inflorescences en verre coulé aux formes lisses. Les reflets de lumière spectaculaires sur les reliefs lisses de l'abat-jour. La source de lumière est une lampe avec culot G9.



1



2



3



4



5

1 **MOD207WL-01BS**

1 x G9 28 W
IP 20

2 **MOD207WL-02BS**

2 x G9 28 W
IP 20

3 **MOD207PL-05BS**

5 x G9 28 W
IP 20

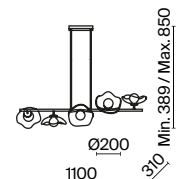
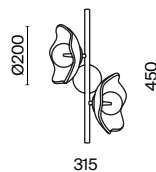
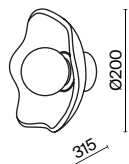



MOD207WL-04BS

4 ■ MOD207PL-03BS

3 × G9 28 W
IP 20

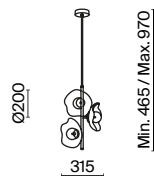

5 ■ MOD207WL-04BS

4 × G9 28 W
IP 20

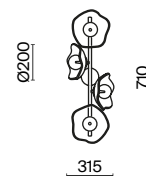

Ros

B **BS**

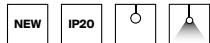

EN Metal fittings, glass dome lamps. Color combinations for fittings and a dome lamp: black + transparent, black + amber, brass + transparent. Decorative elements are blown glass beads. Adjustable wire height. Light source - lamp with a GU10 base.

DE Beschläge - Metall, Lampenschirme - Glas. Farbkombination der Beschläge und Lampenschirme: Schwarz + transparent, Schwarz + Bernstein, Messing + transparent. Dekorelemente - geblasene Glasperlen. Die einstellbare Kabelhöhe. Lichtquelle - Leuchtmittel mit GU10-Fassung.

IT L'armatura è in metallo, paralumi sono in-vetro. Combinazioni di colori dell'armatura e del paralume sono nero + trasparente, nero + ambra, ottone + trasparente. Gli elementi decorativi sono "perline" soffiate in vetro. L'altezza dei cavi è regolabile. La sorgente dell'illuminazione sono le lampadine con portalampade GU10.

FR Armature - métal, abat-jour - verre. Combinaisons de couleurs de l'armature et de l'abat-jour : noir + transparent, noir + ambré, laiton + transparent. Les éléments décoratifs sont des "perles" en verre soufflé. La hauteur des fils est réglable. Source de lumière - lampe avec culot GU10.



- 1 ■ **MOD227PL-01B**
- **MOD227PL-01B1**
- **MOD227PL-01BS**

1 x GU10 28W
IP 20

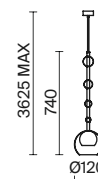



Sintesi

CH

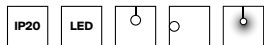

EN Chrome-plated metal fittings. Dome lamps made of glass, color - chrome. LED source with a color temperature of 3000K. Bi-directional light flux - up and down. Optical wave effect along the outer glass element.

DE Verchromte Metallbeschlage. Lampenschirme aus Glas, in Chrom. LED-Lichtquelle mit einer Farbtemperatur von 3000K. Bidirektionaler Lichtstrom: nach oben und nach unten gerichtet. Optischer Welleneffekt auf dem ueren Glaselement.

IT Armatura in metallo cromato. Plafoniere in vetro, colore - cromo. Sorgente LED con temperatura di colore 3000K. Flusso luminoso bidirezionale - in alto e in basso. Effetto onda ottica sull'elemento esterno in vetro.

FR Armature metallique chromee. Globes en verre, couleur : chrome. Source LED avec une temperature de couleur de 3000K. Flux lumineux bidirectionnel : vers le haut et vers le bas. Effet optique de vague sur l'element en verre exterieur.



1 ■ **P090PL-L12CH3K**

LED 12W 420lm
t° 3000K >80Ra 120°
IP 20

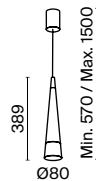

2 ■ **P090WL-L24CH3K**

LED 24W 840lm
t° 3000K >80Ra 120°
IP 20

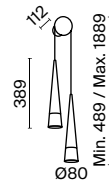



P090WL-L24CH3K

Telford

G

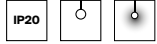

EN Metal fittings of gold color. Dome lamps of frosted white glass. Telford decorative element of dome lamp – steel wire grating of the same color as the fittings. Adjustable height.

DE Metallbeschläge in Gold. Lampenschirm aus weißem Milchglas. Dekor des Lampenschirms Telford: ein Stahldrahtgitter im Farbton der Beschläge. Einstellbare Höhe.

IT Armatura in metallo color oro. Plafoniera in vetro bianco opaco. Soffitto decorativo Telford - griglia in filo d'acciaio da abbinare ai Armatura. Altezza regolabile.

FR Armature en métal de couleur dorée. Globe en verre blanc mat. Décoration du globe Telford : grille en fils d'acier de la couleur de l'armature. Hauteur réglable.



P361PL-01G

P363PL-01G

P363PL-01G

1 **P361PL-01G**

1 x G9 25W
IP 20

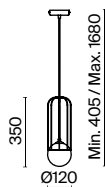

2 **P362PL-01G**

1 x E27 60W
IP 20

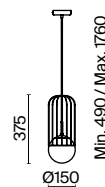

3 **P363PL-01G**

1 x E27 60W
IP 20

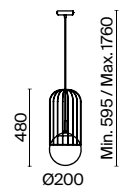

Tessara

G

NEW

LED

IP20



EN Metal fittings of gold color. Spherical dome lamps – white plastic. Design with molecular structure simulation. LED light sources.

DE Metallbeschläge in Gold. Kugelförmige Lampenschirme aus weißem Kunststoff. Design mit Nachahmung der Molekularstruktur. LED-Lichtquellen.

IT Armatura in metallo color oro. Plafoniere-sfere - plastica bianca. Design con imitazione della struttura molecolare. Sorgenti luminose a LED.

FR Armature en métal de couleur dorée. Globes sphériques en plastique blanc. Design avec imitation d'une structure moléculaire. Source de lumière LED.



1 ■ **MOD081CL-L48G3K**

LED 48W -lm
t° 3000K >80Ra 120°
IP 20

2 ■ **MOD081CL-L36G3K**

LED 36W -lm
t° 3000K >80Ra 120°
IP 20

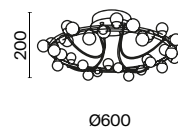
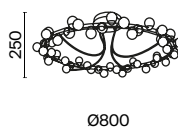

Tropic

BS

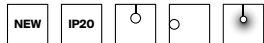

EN Metal fittings, shade – brass. Dome lamps are made of white glass. On-trend tropical plant motifs in a decor with artistic embossing. Adjustable height of the pendant lamp. G9 base. Lamps are not included.

DE Metallbeschläge, Farbton - Messing. Lampenschirme aus weißem Glas. Trendige Motive der tropischen Pflanzen im Dekor mit Kunstausprägung. Pendelleuchten mit einstellbarer Höhe. G9-Fassung. Lampen nicht im Lieferumfang enthalten.

IT Il materiale dell'armatura è il metallo, il colore è ottone. I paralumi sono fatti in vetro bianco. I motivi di tendenza delle piante tropicali nell'arredamento con il conio artistico. Le lampade a sospensione sono regolabili in altezza. Il portalampada è G9. Le lampadine non sono disponibili su questo modello.

FR Armature métallique, teinte - laiton. Abat-jour en verre blanc. Motifs tendance de plantes tropicales dans le décor avec bossellement artistique. Hauteur de la lampe à suspension réglable. Culot G9. Les lampes ne sont pas incluses.



1 ■ **MOD164PL-06BS**

⚡ 6 × G9 40W
IP 20

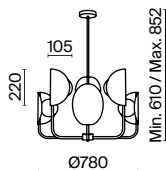

2 ■ **MOD164WL-02BS**

⚡ 2 × G9 40W
IP 20

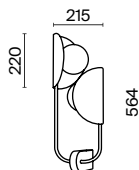

3 ■ **MOD164WL-02BS1**

⚡ 2 × G9 40W
IP 20

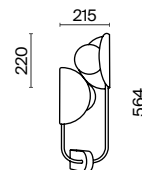



MOD164PL-06BS

MOD164WL-02BS

Ventura

MG

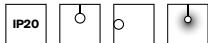

EN Metal fittings of matte gold tint. Individual elements are painted in black color. Amber glass dome lamps. Original elongated shape of dome lamps. Adjustable height of a pendant.

DE Metallbeschläge in mattem Gold. Die einzelnen Elemente sind schwarz lackiert. Lampenschirme aus Glas in Bernstein. Lampenschirme mit einer eigenartigen langgestreckten Form. Einstellbare Höhe der Pendelleuchte.

IT Armatura in metallo color oro opaco. I singoli elementi sono tinti di nero. Plafoniere di vetro color ambra. Originale forma allungata delle plafoniere. Altezza di sospensione regolabile.

FR Armature métallique, teinte dorée mat. Éléments distincts teintés en noir. Globes en verre de teinte ambre. Forme étirée originale des globes. Hauteur de la suspension réglable.



1 ■ **MOD012CL-12G**

💡 12 x G9 28 W
IP 20

2 ■ **MOD012WL-02G**

💡 2 x G9 28 W
IP 20

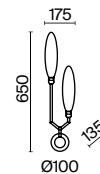
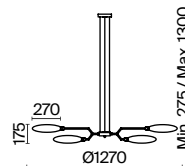



Verticale

CH CH
CG CG

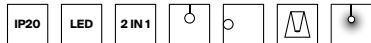

EN Fittings material- metal, color - chrome. Decorative dome lamp of cast ribbed glass. Dome lamp colors: cognac and chrome. Light source - LED strip. Color temperature is 3000K.

DE Metallbeschläge, Farbton: Chrom. Dekorativer Lampenschirm aus gegossenem geripptem Glas. Farbtöne des Lampenschirms: Cognac und Chrom. Lichtquelle: Lichtband. Farbtemperatur 3000K.

IT Materiale dell'armatura - metallo, colore - cromo. Plafoniera decorativa in vetro calato costolato. Tonalità della plafoniera: cognac e cromo. La sorgente luminosa è una striscia LED. Temperatura di colore 3000K.

FR Matériau de l'armature : métal, couleur : chrome. Globe décoratif en verre coulé nervuré. Teintes du globe: cognac et chrome. Source de lumière : ruban LED. Température de couleur 3000K.



1



2

MOD308PL-L9CG3K
 MOD308PL-L9CH3K

MOD308WL-L9CG3K
 MOD308WL-L9CH3K

LED 8 W 800lm
t° 3000K >80Ra 180°
IP 20

LED 8 W 800lm
t° 3000K >80Ra 180°
IP 20

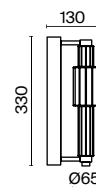
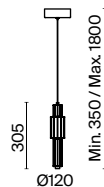



Vision

EN Fittings – aluminum, color – gold. Double glass dome lamp: internal – frosted, external – transparent. Style – Italian neoclassical. Iconic shapes of the 60s in design.

DE Aluminiumbeschläge, Farbton: Gold. Doppelter Lampenschirm aus Glas: Innenseite matt, Außenseite transparent. Stil: Italienische Neoklassik. Kultige Formen der 60er Jahre im Design.

IT Armatura - alluminio, colore - oro. Doppia plafoniera in vetro: interna - opaca, esterna - trasparente. Stile - neoclassico italiano. Forme iconiche degli anni '60 nel design.

FR Armature : aluminium, couleur : dorée. Globe double en verre : intérieur mat, extérieur transparent. Style : italien néoclassique. Formes culte du design des années 60.

G



1



2



3

1 ■ **MOD411WL-01G**

💡 1 x E14 60 W
IP 20

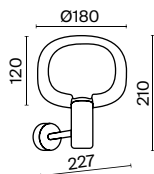

2 ■ **MOD411PL-03G**

💡 3 x E14 60 W
IP 20

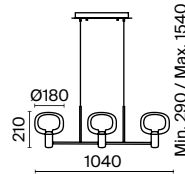

3 ■ **MOD411PL-06G**

💡 6 x E14 60 W
IP 20

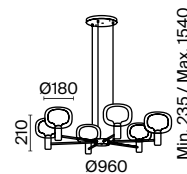

Verre

BS

IP20



EN Fittings – metal, shade – brass. Double lampshade, textile of two types: linen, translucent organza. Transparent elements: blown glass, cast acrylic base.

DE Metallbeschläge, Farbton: Messing. Doppelter Lampenschirm aus zwei Arten von Textil: Leinen, durchscheinender Organza. Transparente Elemente: geblasenes Glas, gegossenes Acryl im Sockel.

IT Armatura – metallo, tonalità – ottone. Doppio paralume, due tipi di tessuti: lino, organza traslucida. Elementi trasparenti: vetro soffiato, piede in acrilico colato.

FR Armature : métal, teinte : laiton. Double abat-jour, textile de deux types : lin, organza translucide. Éléments transparents : verre soufflé, acrylique coulé dans la base.



Z005TL-01BS

1 ■ **Z005TL-01BS**

💡 1 x E27 40W
IP 20

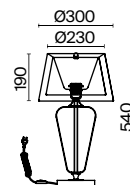

Mabell

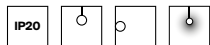



EN Metal fittings in three shades: chrome, copper and gold. Plated glass dome lamps have the same color as the fittings. Original textured shape of dome lamps. Light source – lamp with E14 base.

DE Metallbeschläge in 3 Farbtönen: Chrom, Kupfer und Gold. Lampenschirme aus Glas mit galvanischer Beschichtung im Farbton der Beschläge. Lampenschirme mit einer eigenartigen strukturierten Form. Lichtquelle: Leuchtmittel mit E14-Fassung.

IT Armatura metallica in tre tonalità: cromo, rame e oro. Plafoniere in vetro con rivestimento galvanico in tinta con l'armatura. Forma strutturata originale delle plafoniere. La sorgente luminosa è una lampadina con attacco E14.

FR Armature métallique en trois teintes: chrome, cuivre et dorée. Globes en verre avec revêtement galvanisé dans la teinte de l'armature. Forme de texture originale des globes. Source de lumière : ampoule à culot E14.



- 1  **MOD306WL-01G**
-  **MOD306WL-01C**
-  **MOD306WL-01CH**

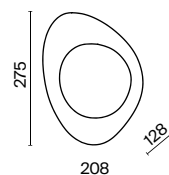

1 × E14 40W
IP 20





Mare

G CH

IP20  

EN Metal and glass fittings. Trendy relief texture on both sides of the disc for variability in interior use. Shades – chrome and brass. Decorative reflector with a mirror finish hides the light source. Lamp with G9 base.



DE Beschläge aus Metall und Glas. Trendige geprägte Textur auf beiden Seiten der Scheibe zur Variabilität der Nutzung im Innenraum. Farbtöne: Chrom und Gold. Ein spiegelbeschichteter dekorativer Reflektor verbirgt die Lichtquelle. Leuchtmittel mit G9-Fassung.

IT Armatura in metallo e vetro. Texture gofrata alla moda su entrambi i lati del disco per la variabilità nell'uso interno. I colori sono cromo e oro. Il riflettore decorativo con finitura a specchio nasconde la sorgente luminosa. Lampadina con attacco G9.

FR Armature en métal et verre. Texture gaufrée tendance des deux côtés du disque pour une variabilité d'utilisation dans l'intérieur. Teintes : chrome et dorée. Le réflecteur décoratif avec revêtement en miroir dissimule la source de lumière. Ampoule à culot G9.



1 

1  **MOD305WL-01G**
 **MOD305WL-01CH**

1 x G9 40 W
 IP 20

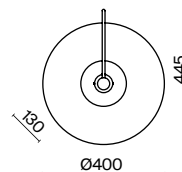



MOD305WL-01G

Prima

BZ CH



EN Fittings – metal. Shades – chrome, brass. Cotton lampshade of white color. Transparent acrylic decorative elements at the base. Bauhaus aesthetics, lampshade trendy shape. Light source – lamp with E27 base.

DE Metallbeschläge, Farbtöne: Chrom, Messing. Lampenschirm aus Baumwolle in Weiß. Transparenter Acryldekor am Sockel. Die Ästhetik des Bauhauses, die trendige Form des Lampenschirms. Lichtquelle: Leuchtmittel mit E27-Fassung.

IT Armatura - metallo. Tonalità: cromo, ottone. Paralume in cotone bianco. Decoro acrilico trasparente del piede. Estetica Bauhaus, forma della plafoniera alla moda. La sorgente luminosa è una lampadina con attacco E27.

FR Armature : métal. Teintes : chrome, laiton. Abat-jour en coton de couleur blanche. Élément décoratif en acrylique blanc dans la base. Esthétique de Bauhaus, forme tendance dell'abat-jour. Source de lumière : ampoule à culot E27.



1



2

1 **Z034WL-01CH**
Z034WL-01BS

2 **Z034TL-01BZ**

1 1 x E27 60 W
IP 20

2 1 x E27 60 W
IP 20

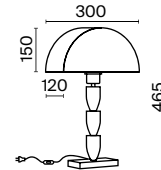
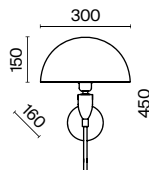



Jupiter

EN Brushed metal fittings, shades - brass, marble. Diffuser of two types: corrugated glass and white matte acrylic. Light source - LED strip, temperature is 3000K.

DE Gebürstete Metallbeschläge, Farbtöne: Messing, Marmor. Zwei Arten von Diffusoren: geriffeltes Glas und weißes mattes Acryl. Lichtquelle: Lichtband, Farbtemperatur 3000K.

IT Armatura in metallo opaco, sfumature - ottone, marmo. Diffusore di due tipologie: vetro ondulato e acrilico bianco opaco. Sorgente luminosa - striscia a LED, temperatura 3000K.

FR Armature métallique mate, teinte : laiton, marbre. Diffuseurs de deux types : verre en relief et acrylique blanc mat. Source lumineuse : ruban LED, température 3000K.

BS MR



1 ■



2 ■



3 ■



4 ■

1 ■ **MOD320WL-L8BS3K** 2 ■ **MOD320WL-L5BS3K** 3 ■ **MOD320WL-L10BS3K** 4 ■ **MOD320WL-L12BS3K**

LED 8W 400lm
t° 3000K >80Ra 120°
IP 20

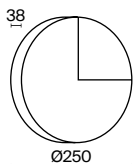

LED 6W 300lm
t° 3000K >80Ra 120°
IP 20

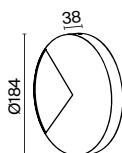

LED 10W 1100lm
t° 3000K >80Ra 120°
IP 20

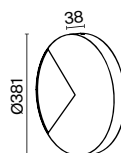

LED 12W 1300lm
t° 3000K >80Ra 120°
IP 20

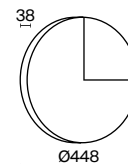



MOD320WL-L10BS3K

MOD320WL-L8BS3K

MOD320WL-L12BS3K

MOD320WL-L5BS3K

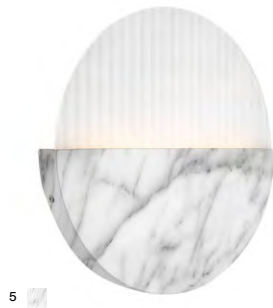

5  MOD320WL-L13MR3K1 6  MOD320WL-L6BS3K1

LED 13W 200lm
 t° 3000K >80Ra 120°
 IP 20

LED 6W 200lm
 t° 3000K >80Ra 120°
 IP 20

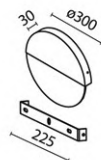

Rotta

B **G**

LED IP20

EN Reinforcement material - aluminum, shades - black, gold. Hidden mount. Balanced black and white pattern. Rotary mechanism for adjusting the light flux. Minimalistic design. Ability to create light compositions. LED source with a color temperature of 3000K.

DE Material der Beschläge: Aluminium, Farbtöne: Schwarz, Gold. Verdeckte Befestigung. Ausgewogenes Licht- und Schattenspiel. Schwenkvorrichtung zur Einstellung des Lichtstroms. Minimalistisches Design. Mit der Möglichkeit, Lichtkompositionen zu schaffen. LED-Quelle mit einer Farbtemperatur von 3000K.

IT Materiale dell'armatura - alluminio, sfumature - nero, oro. Montatura nascosta. Immagine bilanciata di luci e ombre. Meccanismo rotante per la regolazione della potenza luminosa. Design minimalista. Possibilità di creare composizioni leggere. Sorgente LED con temperatura di colore 3000K.

FR Matériau de l'armature : aluminium, teinte : noir, dorée. Fixation invisible. Motif noir et blanc équilibré. Mécanisme de rotation pour le réglage du flux lumineux. Design minimaliste. Possibilité de créer des compositions lumineuses. Source LED avec une température de couleur de 3000K.



1 **MOD413WL-L6B3K**
MOD413WL-L6G3K

2 **MOD413WL-L8B3K**
MOD413WL-L8G3K

LED 6W 400lm
t° 3000K >80Ra 120°
IP 20

LED 8W 600lm
t° 3000K >80Ra 120°
IP 20

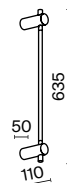

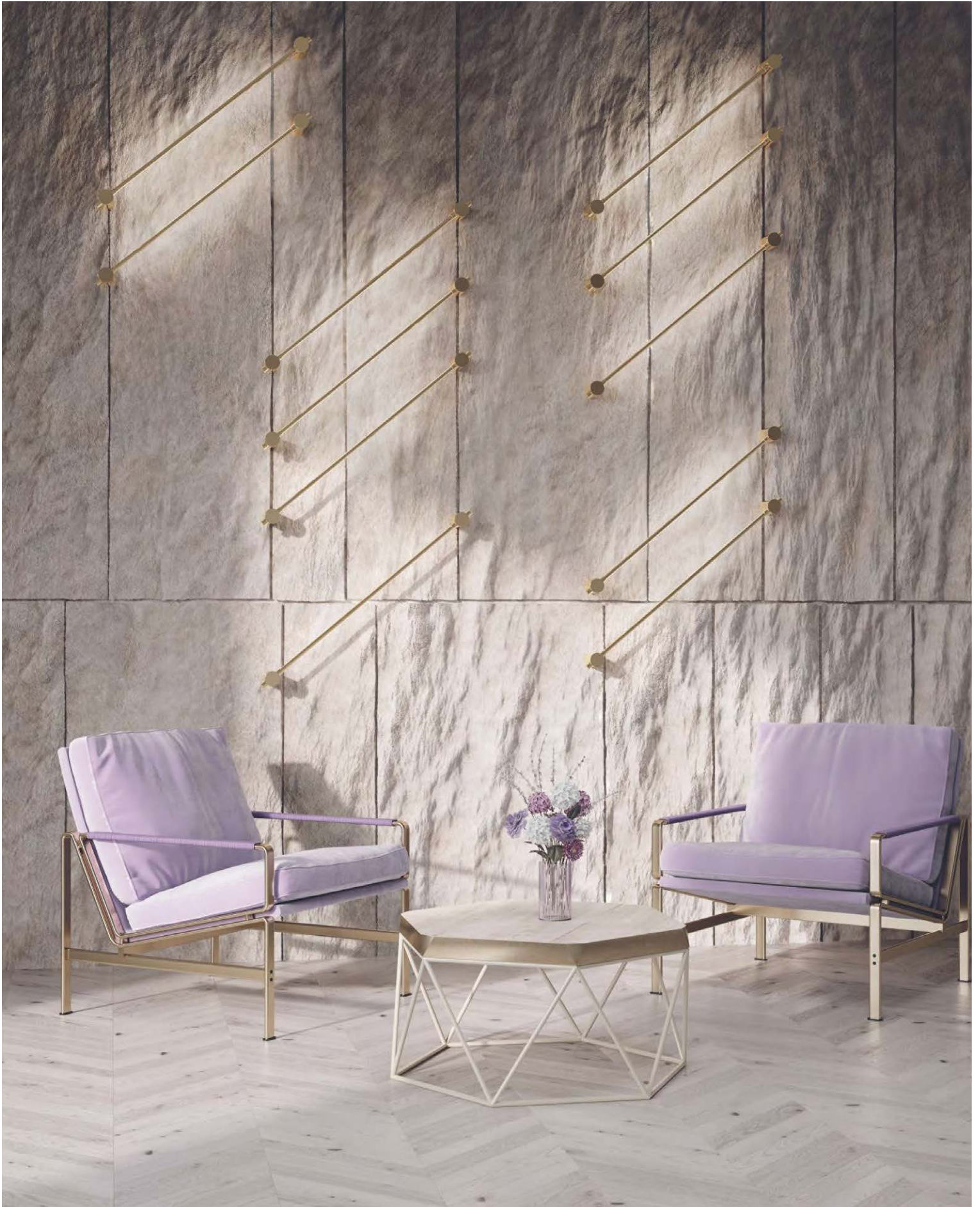

MOD413WL-L6G3K

Cerezo

CH

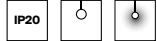

EN Metal fittings, color – chrome. Dome lamp is made up of transparent optical glass plates. The metal frame of the dome lamp is colored to match the fittings. Height of pendant models is adjustable.

DE Metallbeschläge in Chrom. Lampenschirm besteht aus transparentem optischem Glas. Metallrahmen des Lampenschirms ist im Farbton der Beschläge gefärbt. Einstellbare Höhe der Pendelmodelle.

IT Armatura in metallo, colore - cromo. La plafoniera è composta da lastre di vetro ottico trasparente. La struttura metallica della plafoniera è verniciata in tinta con l'armatura. L'altezza dei modelli a sospensione è regolabile.

FR Armature en métal, couleur : chrome. Globe composé de plaques de verre optique transparent. Car-casse métallique du globe dans la teinte de l'armature. Hauteur des modèles de suspensions réglable.



1



2

1 **MOD201PL-08N**

8 × E14 40W
IP 20

2 **MOD201PL-01N**

1 × E14 40W
IP 20

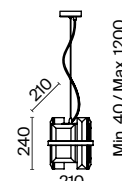
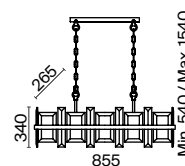



MOD201PL-01N

Coil

CH

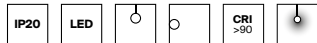

EN Stainless steel and glass fittings, fittings color – chrome. Textured dome lamp with glass decorative elements. Light source – LEDs with a color temperature of 3000K.

DE Beschläge aus Edelstahl und Glas, Farbton der Beschläge: Chrom. Fakturierter Lampenschirm mit Dekor aus Glasmassiv. Lichtquelle: LEDs mit einer Farbtemperatur von 3000K.

IT Armatura in acciaio inox e vetro, colore dell'armatura - cromo. Plafoniera strutturata con decori in vetro massiccio. La sorgente luminosa è LED con una temperatura di colore di 3000K.

FR Armature en acier inoxydable et en verre, couleur de l'armature : chrome. Globe texturé avec élément décoratif en verre massif. Source de lumière : LED avec une température de couleur de 3000K.



1



2

1 **MOD124PL-L3CH3K**

LED 3W 200lm
 t° 3000K >90Ra 360°
 IP 20

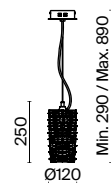

2 **MOD124WL-L6CH3K**

LED 6W 300lm
 t° 3000K >90Ra 360°
 IP 20

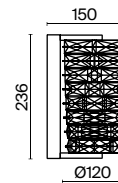



MOD124WL-L6CH3K

Dune

G CH

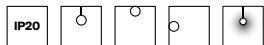

EN Metal fittings in two colors: chrome, gold. Decorative elements— clear crystals. Ceiling models have two tiers of pendants. Height of the pendant chandelier is adjustable using cable.

DE Metallbeschläge in 2 Farbtönen: Chrom und Gold. Dekor: transparente Kristalle. Deckenmodelle haben zwei Schichten von Anhängern. Durch ein Seil einstellbare Höhe der Pendel-Kronleuchte.

IT Armatura metallica in due tonalità: cromo, oro. Decoro - cristalli trasparenti. I modelli da soffitto hanno due livelli di pendenti. L'altezza del lampadario a sospensione è regolabile con un cavo.

FR Armature métallique en deux teintes : chrome, dorée. Élément décoratif: cristaux transparents. Les modèles de plafond disposent de deux niveaux de pendentifs. Hauteur du lustre suspendu réglable par câble.



1



2



3



4

DIA005CL-06G
DIA005CL-06CH

6 × E14 60 W
IP 20

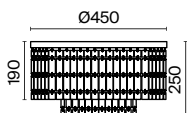

DIA005CL-10CH

10 × E14 60 W
IP 20

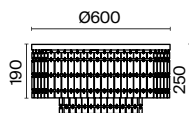

DIA005PL-06G

6 × E14 60 W
IP 20

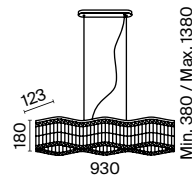

DIA005WL-02G

2 × E14 60 W
IP 20

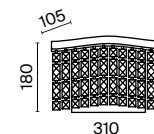



DIA005PL-06G

Facet

G CH

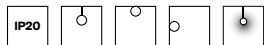

EN Fittings material – metal, shades – chrome and gold. Decorative elements – transparent glass crystals. Architectural faceting of decorative elements. Light source – lamps with E14 base.

DE Metallbeschläge, Farbtöne: Chrom und Gold. Dekor: transparente Glaskristalle. Architektonischer Schliff von dekorativen Elementen. Lichtquelle: Leuchtmittel mit E14-Fassung.

IT Materiale dell'armatura - metallo, Plafoniere - cromo e oro. Decoro - cristalli di vetro trasparenti. Staccature architettoniche di elementi decorativi. Sorgente luminosa - lampadine con attacco E14.

FR Matériau de l'armature : métal, teintes : chrome et dorée. Élément décoratif : cristaux de verre transparent. Taille architecturale des éléments décoratifs. Source de lumière: ampoules à culot E14.



1



2



3



4

1 **MOD094CL-04CH**
MOD094CL-04G

⚡ 4 x E14 60 W
IP 20

2 **MOD094CL-06CH**
MOD094CL-06G

⚡ 6 x E14 60 W
IP 20

3 **MOD094WL-03CH**
MOD094WL-03G

⚡ 3 x E14 60 W
IP 20

4 **MOD094WL-01CH**
MOD094WL-01G

⚡ 1 x E14 60 W
IP 20

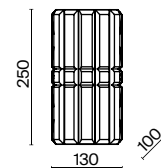
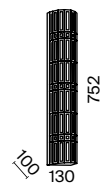
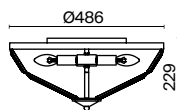
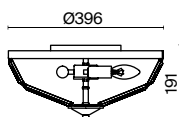



Flare

G

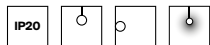

EN Fittings material— metal, color — gold. Decorative elements— crystal of large architectural faceting. Height of pendant chandeliers is adjustable by chain. Light source — lamps with E14 base.

DE Metallbeschläge, Farbton: Gold. Dekor: Kristall mit großformatigem architektonischem Schnitt. Durch eine Kette einstellbare Höhe der Pendel-Kronleuchte. Lichtquelle: Leuchtmittel mit E14-Fassung.

IT Materiale dell'armatura - metallo, colore - oro. Decoro: cristallo di grandi dimensioni con taglio architettonico. L'altezza dei lampadari a sospensione è regolabile con una catena. Sorgente luminosa - lampadine con attacco E14.

FR Matériau de l'armature : métal, couleur : dorée. Élément décoratif : cristal taillé architecturalement en grande dimension. Hauteur des lustres suspendus réglable par une chaîne. Source de lumière : ampoules à culot E14.



1



2



3

DIA200PL-08G

8 x E14 40 W
IP 20

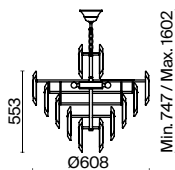

DIA200PL-06G

6 x E14 40 W
IP 20

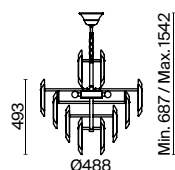

DIA200WL-02G

2 x E14 40 W
IP 20

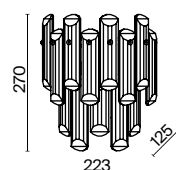



DIA200PL-06G

Frame

G



EN Fittings material – metal, shade – gold. Decorative element made of transparent glass in the form of embossed tubes. E14 base. Lamps are not included.

DE Material der Beschläge - Metall, Farbton - Gold. Dekoratives Element aus transparentem Glas in Form von geprägten Röhren. E14-Fassung. Lampen nicht im Lieferumfang enthalten.

IT Il materiale dell'armatura è metallo, il colore è oro. L'elemento decorativo è realizzato in vetro trasparente sotto forma di tubi in rilievo. Il portalampada è E14. Le lampadine non sono disponibili su questo modello.

FR Matériel de l'armature - métal, teinte - or. Élément décoratif en verre transparent en forme de tubes en relief. Culot E14. Les lampes ne sont pas incluses.



1



2



3



4

1 **MOD174CL-06G**

6 x E14 60 W
IP 20

2 **MOD174CL-09G**

9 x E14 60 W
IP 20

3 **MOD174PL-06G**

6 x E14 60 W
IP 20

4 **MOD174WL-02G**

2 x E14 60 W
IP 20

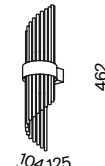
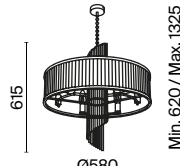
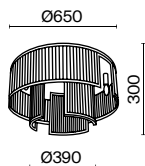
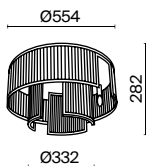



MOD174PL-06G

MOD174WL-02G

Gelid

CH



EN Metal fittings, color – chrome. Lampshades frame – metal, decorative elements– transparent crystal glass. Height of pendant lamps is adjustable.

DE Metallbeschläge in Chrom. Rahmen des Lampenschirms: Metall, Dekor: transparenter Kristall. Einstellbare Höhe der Pendelleuchte.

IT Armatura in metallo, colore - cromo. La struttura del paralume è in metallo, il decoro è in cristallo trasparente. L'altezza delle lampade a sospensione è regolabile.

FR Armature métallique, couleur chrome. Carcasse de l'abat-jour : métal, élément décoratif : cristal transparent. Hauteur des suspensions réglable.



1



2



3

MOD184-PL-04-CH

4 x E27 60 W
IP 20

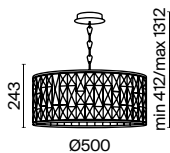

MOD184-PL-01-CH

1 x E27 60 W
IP 20

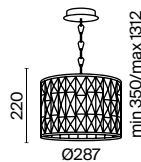

MOD184-WL-01-CH

1 x E27 60 W
IP 20

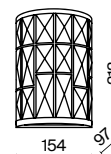



Hail

CH

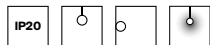

EN Metal fittings, color – chrome. Crystal decorative elements of two types: large, elongated along the outer perimeter and rounded on pendants. Height of pendant models is adjustable. Light source – lamps with E14 base.

DE Metallbeschläge in Chrom. Zwei Arten von Kristalldekor: ein großer, länglicher am äußeren Rand und ein abgerundeter Dekor mit Anhängern. Einstellbare Höhe der Pendelmodelle. Lichtquelle: Leuchtmittel mit E14-Fassung.

IT Armatura in metallo, colore - cromo. Decoro in cristallo di due tipologie: grande, allungato lungo il perimetro esterno, e arrotondato sui pendenti. L'altezza dei modelli a sospensione è regolabile. Sorgente luminosa - lampadine con attacco E14.

FR Armature en métal, couleur : chrome. Éléments décoratifs en cristal de deux types : important étiré sur le périmètre extérieur et arrondi sur les pendants. Hauteur des modèles de suspension réglable. Source de lumière : ampoules à culot E14.



MOD097PL-08CH

8 x E14 40 W
IP 20

MOD097WL-02CH

2 x E14 40 W
IP 20

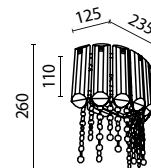
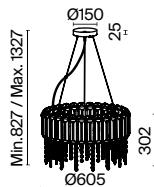



Krone

G BS

NEW IP20 LED CRI >90

EN Metal fittings of gold color. Asymmetrical crystal decoration. Trendy circle shape. LED light source with temperature of 4000K. High color rendering index is 90Ra.

DE Metallbeschläge in Gold. Asymmetrischer Kristalldekor. Trendige Kreisform. LED-Lichtquelle mit einer Farbtemperatur von 4000K. Hoher Farbwiedergabeindex von 90Ra.

IT Armatura in metallo color oro. Decoro asimmetrico in cristallo. Forma circolare alla moda. Sorgente luminosa a LED con una temperatura di 4000K. Alto indice di resa cromatica 90Ra.

FR Armature métallique de couleur dorée. Élément décoratif asymétrique en cristal. Forme ronde tendance. Source de lumière LED avec une température de 4000K. Indice de rendu de couleur élevé : 90Ra.



1 ■ **P097PL-L90G4K**

LED 90W 6000lm
t° 4000K >90Ra 180°
IP 20

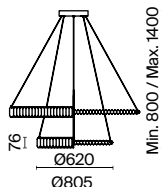

2 ■ **P097PL-L36G4K**

LED 36W 2400lm
t° 4000K >90Ra 180°
IP 20

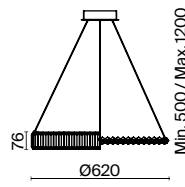

3 ■ **P097PL-L45G4K**

LED 45W 3000lm
t° 4000K >90Ra 180°
IP 20

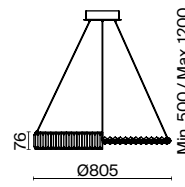



Krone

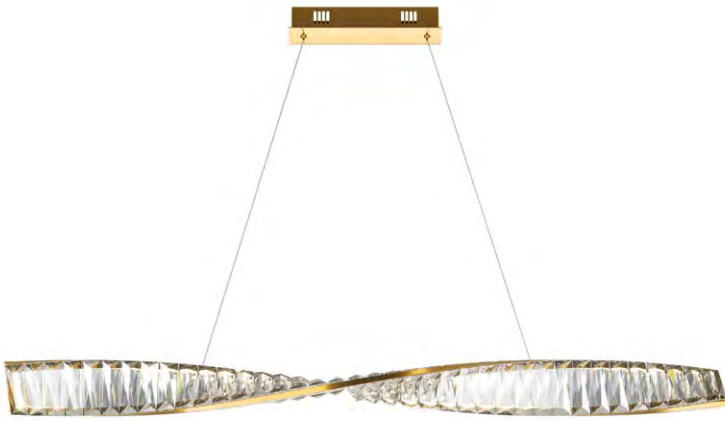

4



5



6

4 ■ **P097PL-L28BS3K**

LED 27W 1900lm
 t° 3000K >80Ra 80°
 IP 20

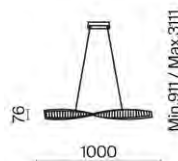

5 ■ **P097PL-L48BS3K**

LED 48W 3300lm
 t° 3000K >80Ra 80°
 IP 20



6 ■ **P097PL-L36BS3K**

LED 36W 2600lm
 t° 3000K >80Ra 80°
 IP 20

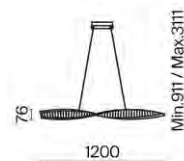



MOD097PL-L36BS3K

Puntes

EN Fittings material— metal, shades – chrome and gold. Decorative elements— bulk crystal of complex cut. Height of pendant models is adjustable by chain length.

DE Metallbeschläge, Farbtöne: Chrom und Gold. Dekor: massive Kristalle mit komplexem Schliff. Durch die Länge der Kette einstellbare Höhe der Pendelmodelle.

IT Materiale dell'armatura - metallo, tonalità - cromo e oro. Decoro: cristalli massicci di taglio complesso. L'altezza dei modelli a sospensione è regolata dalla lunghezza della catena.

FR Matériau de l'armature : métal, teintes : chrome et dorée. Élément décoratif : cristaux massifs à structure complexe. Hauteur des modèles de suspensions réglable par une longue chaîne.

CH G



1



2



3

1 **MOD043FL-08CH**
MOD043FL-08G

⚡ 8 × E14 60 W
IP 20

2 **MOD043TL-02CH**
MOD043TL-02G

⚡ 2 × E14 60 W
IP 20

3 **MOD043WL-01CH**
MOD043WL-01G

⚡ 1 × E14 60 W
IP 20

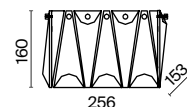
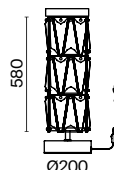



MOD043TL-02G

MOD043FL-08G

Puntes



6



5



4



7

4 **MOD043PL-12CH**
MOD043PL-12G

💡 12 x E14 40 W
IP 20

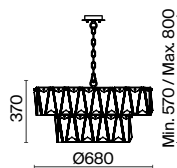

5 **MOD043PL-04G**

💡 4 x E14 60 W
IP 20

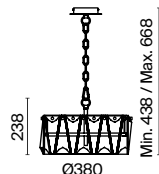

6 **MOD043PL-18CH**
MOD043PL-18G

💡 18 x E14 40 W
IP 20

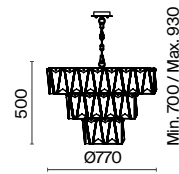

7 **MOD043PL-06CH**
MOD043PL-06G

💡 6 x E14 60 W
IP 20

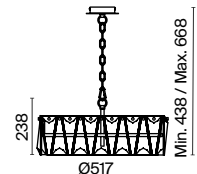



Revero

G BS

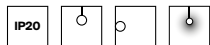

EN Metal fittings in two colors: brass, gold. Multi-layered decoration. Pendants: transparent (fittings – brass) and amber (fittings – gold) glass. Height of pendant models is adjustable.

DE Metallbeschläge in zwei Farbtönen: Messing, Gold. Mehrstufiger Dekor. Anhänger: transparentes (Beschläge: Messing) und bernsteinfarbenes (Beschläge: Gold) Glas. Einstellbare Höhe der Pendelmodelle.

IT L'armatura e' in metallo in due tonalità: l'ottone, l'oro. Decoro a più livelli. Pendenti: vetro trasparente (armatura: ottone) e ambra (armatura: ottone). L'altezza dei modelli a sospensione è regolabile.

FR Armature en métal, en deux teintes : laiton, dorée. Élément de décoration sur plusieurs niveaux. Pendants : verre transparent (armature : laiton) et ambre (armature : dorée). Hauteur des modèles de suspensions réglable..



1



2



3



4

MOD085PL-12BS

12 x E14 40 W
IP 20

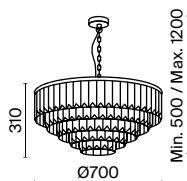

MOD085PL-16BS

16 x E14 40 W
IP 20

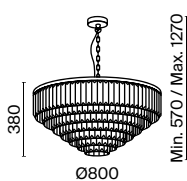

MOD085PL-07G
MOD085PL-07BS

7 x E14 40 W
IP 20

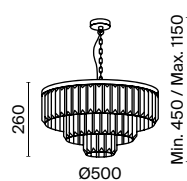

MOD085WL-01G
MOD085WL-01BS

1 x E14 40 W
IP 20

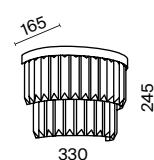



Wonderland

G

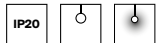

EN Stainless steel fittings of gold color. Dome lamp of blown glass, inside – crystal pendants. Part of the dome lamps with a mirror finish to match the fittings. Light source – lamps with E14 base.

DE Beschläge aus Edelstahl in Gold. Lampenschirm aus geblasenem Glas, mit Kristallanhänger innen. Ein Teil des spiegelbeschichteten Lampenschirms im Farbton der Beschläge. Lichtquelle: Leuchtmittel mit E14-Fassung.

IT Armatura in acciaio inossidabile color oro. Plafoniera in vetro soffiato con pendenti in cristallo all'interno. Parte della plafoniera con rivestimento a specchio in tinta con l'armatura. Sorgente luminosa - lampadine con attacco E14.

FR Armature en acier inoxydable de couleur dorée. Globe en verre soufflé, à l'intérieur pendentifs en cristal. Partie du globe avec revêtement en miroir dans la teinte de l'armature. Source de lumière : ampoules à culot E14.



1



2

1 **MOD313PL-06G**

6 x E14 60 W
IP 20

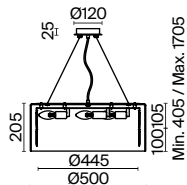

2 **MOD313PL-04G**

4 x E14 60 W
IP 20

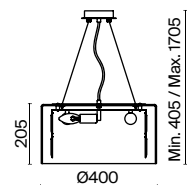

Recinto

CH

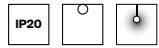

EN Metal fittings, color – chrome. Decorative elements – rectangular crystal plates. Light sources are hidden under textured glass. The height of the lamps is adjustable using cable.

DE Metallbeschläge in Chrom. Dekor: Rechteckige Kristallplatten. Lichtquellen sind unter dem fakturierten Glas verdeckt. Durch ein Seil einstellbare Höhe der Leuchten.

IT Armatura in metallo, colore - cromo. Decoro - piastre di cristallo rettangolari. Le sorgenti luminose sono nascoste sotto il vetro strutturato. L'altezza delle lampade è regolabile con un cavo.

FR Armature métallique, couleur : chrome. Élément décoratif : plaques de cristal rectangulaires. Sources de lumière dissimulée sous verre texturé. Hauteur des luminaires réglable par câble.



1



2

1 ■ **MOD080CL-08CH**

⚡ 8 × E27 60 W
IP 20

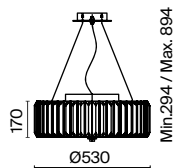
2 ■ **MOD080CL-06CH**

⚡ 6 × E27 60 W
IP 20

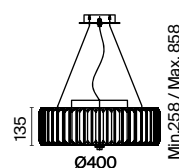

Basic colors

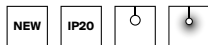

EN Fittings material – metal. Shades – black, white and two instant shades of gray. Universal and basic forms of dome lamps. Included: a hook, an additional base and a metal element allowing you to fix the suspension in the desired area or use it as a wall lamp. E27 base. Lamps are not included.

DE Material der Beschläge - Metall. Farbtöne - Schwarz, Weiß, sowie zwei aktuelle Grautöne. Universelle und grundlegende Formen von Lampenschirmen. Im Lieferumfang enthalten: Haken, zusätzliche Basis und metallisches Element, mit denen Sie die Pendelleuchte an der gewünschten Stelle befestigen oder als Wandleuchte verwenden können. E27-Fassung. Lampen nicht im Lieferumfang enthalten.

IT Il materiale dell'armatura è il metallo. I colori sono nero, bianco e anche due sfumature di grigio moderne. I paralumi sono in forme universali e di base. Il kit include un gancio, una base aggiuntiva e un elemento metallico che fissano una sospensione nella zona desiderata. Si può utilizzarla come applique. Il portalam-pada è E27. Le lampadine non sono disponibili su questo modello.

FR Matériel de l'armature - métal. Teintes - noir, blanc et également deux nuances de gris actuelles. Formes universelles et basiques des abat-jour. Crochet, base supplémentaire et élément métallique sont inclus. Ils permettent de fixer la suspension à l'endroit souhaité ou de l'utiliser comme applique murale. Culot E27. Les lampes ne sont pas incluses.



- 1 ■ MOD167PL-01B
- MOD167PL-01BG
- MOD167PL-01W
- MOD167PL-01GR

- 2 ■ MOD168PL-01B
- MOD168PL-01BG
- MOD168PL-01W
- MOD168PL-01GR

1 × E27 40 W
IP 20

1 × E27 40 W
IP 20

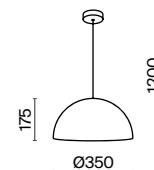
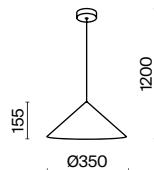



MOD167PL-01BG

MOD167PL-01W

Bowi

G

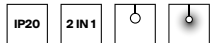

EN Fittings – metal, color – gold. Dome lamps of transparent glass. Frame made of metal frames superimposed on each other. Mount 2 in 1 – mounting with or without chain.

DE Metallbeschläge in Gold. Lampenschirme aus transparentem Glas. Rahmen aus übereinander angeordneten Metallrähmchen. 2-in-1-Befestigung; Montage mit oder ohne Kette.

IT Armatura - metallo, colore - oro. Plafoniere in vetro trasparente. Struttura dai telai metallici sovrapposti l'uno all'altro. Attacco 2 in 1 - montaggio con o senza catena.

FR Armature : métal, couleur: dorée. Globes en verre transparent. Carcasse de cadres métalliques superposés les uns sur les autres. Fixation 2 en 1 : pose avec ou sans chaîne.



H009PL-06G

6 × E14 40W
IP 20

H009PL-08G

8 × E14 40W
IP 20

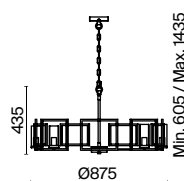
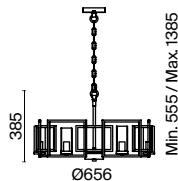



Dynamics

MG MB MW

NEW IP20 



EN Fittings material— aluminum. Powder coating in three colors: matte black, matte white, matte gold. Dome lamp with trendy corrugated texture. Pendant models with external glass elements. Bright key-light.

DE Material der Beschläge: Aluminium. Pulverbeschichtung in drei Farbtönen: Mattes Schwarz, Mattes Weiß, Mattes Gold. Lampenschirm mit einer trendigen, geriffelten Textur. Pendelmodelle mit einem äußeren Glaselement. Helles gerichtetes Licht.

IT Materiale dell'armatura - alluminio. Verniciato a polvere in tre colori: nero opaco, bianco opaco, oro opaco. Plafoniere con trama ondulata alla moda. Modelli a sospensione con elemento esterno in vetro. Luce direzionale vivida.

FR Matériau de l'armature : aluminium. Revêtement par poudre en trois couleurs : noir mat, blanc mat, dorée mat. Globe avec texture ondulée tendance. Modèles de suspensions avec élément en verre extérieur. Lumière orientée vivide.



- 1  **MOD326WL-02MG**
-  **MOD326WL-02W**
-  **MOD326WL-02B**

 2 x GU10 50 W
IP 20

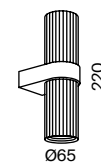



MOD326WL-02B



EN Metal body, color palette: black, white, brass, gold and terracotta. Two types of dome lamps: "tablet" with a graphic pattern of asymmetrical lines; "tablet" + perfectly smooth metal "plate". The design is inspired by the suprematist aesthetics of El Lissitzky. LED light source, color temperature: 3000K. A 3-meter adjustable wire.

DE Metallgehäuse, Farbpalette - Schwarz, Weiß, Messing, Gold und Terrakotta. Zwei Arten von Lampenschirmen: "Tablette" mit einem grafischen Relief aus asymmetrischen Linien; "Tablette" + perfekt glatte Metall-"Platte". Das Design ist inspiriert von der suprematistischen Ästhetik von El Lissitzky. LED-Lichtquelle, Farbtemperatur - 3000K. Verstellbares Kabel - 3 Meter.

IT Il corpo fatto in metallo, la tavolozza dei colori e' nero, bianco, ottone, oro e terracotta. Due tipi di paralumi: una "tavoletta" con un rilievo grafico di linee asimmetriche; una "tavoletta" + un "piatto" di metallo perfettamente liscio. Il design è ispirato all'estetica suprematista di El Lissitzkij (in russo - Эль Лисицкий). La sorgente luminosa a LED, la temperatura di colore e' 3000K. Il cavo regolabile di 3 metri.

FR Corps en métal, palette de couleurs : noir, blanc, laiton, or et terre cuite. Deux types d'abat-jour : «tablette» avec un relief graphique de lignes asymétriques ; «tablette» + « plaque» métallique parfaitement lisse. Le design s'inspire de l'esthétique suprématisiste d'El Lissitzky. Source de lumière LED, température de couleur - 3000K. Fil réglable - 3 mètres.

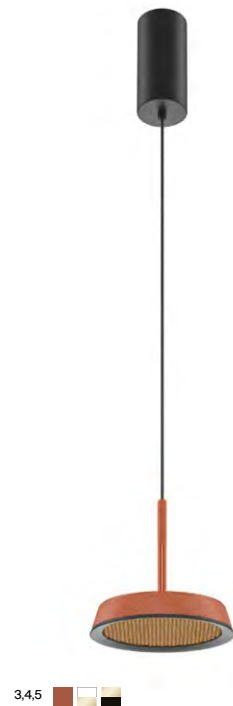

1 **MOD041PL-L15W3K1**

LED 15W 800 lm
t° 3000K >80Ra 90°
IP 20

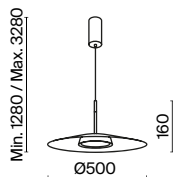

2 **MOD041PL-L15B3K1**

LED 15W 500 lm
t° 3000K >80Ra 90°
IP 20

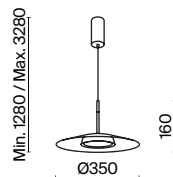

3 **MOD041PL-L15GB3K**

LED 15W 650 lm
t° 3000K >80Ra 90°
IP 20

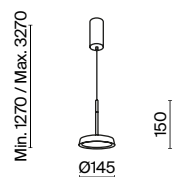



MOD041PL-L15B3K1

4 ■ MOD041PL-L15TR3K

LED 15W 700lm
 t° 3000K >80Ra 90°
 IP 20

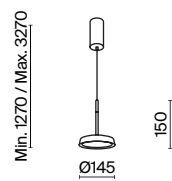

5 ■ MOD041PL-L15WG3K

LED 15W 800lm
 t° 3000K >80Ra 90°
 IP 20

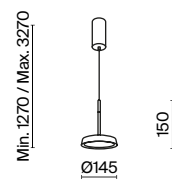

Enigma

BS W

NEW IP20 CRI >90

EN Metal fittings. Two color scores: black + brass, black + white. Light height and direction are adjustable. LED source with a color temperature of 3000K. High color rendering index is 90Ra.

DE Metallbeschläge. Zwei Farbtöne: Schwarz mit Messing, Schwarz mit Weiß. Einstellbare Höhe und Lichtrichtung. LED-Lichtquelle mit einer Farbtemperatur von 3000K. Hoher Farbwiedergabeindex von 90Ra.

IT Armatura metallica. Due combinazioni di colori: nero + ottone, nero + bianco. L'altezza e la direzione della luce sono regolabili. Sorgente LED con temperatura di colore 3000K. Alto indice di resa cromatica 90Ra.

FR Armature métallique. Deux choix de couleurs: noir + laiton, noir + blanc. Hauteur et direction de la lumière réglables. Source LED avec une température de couleur de 3000K. Fort indice de rendu de couleur de 90Ra.



1 ■ ■

1 ■ **MOD150PL-L5BS3K**
 □ **MOD150PL-L5W3K**

LED 5W 350lm
 t° 3000K >90Ra 36°
 IP 20

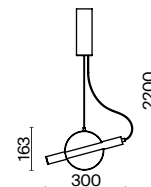

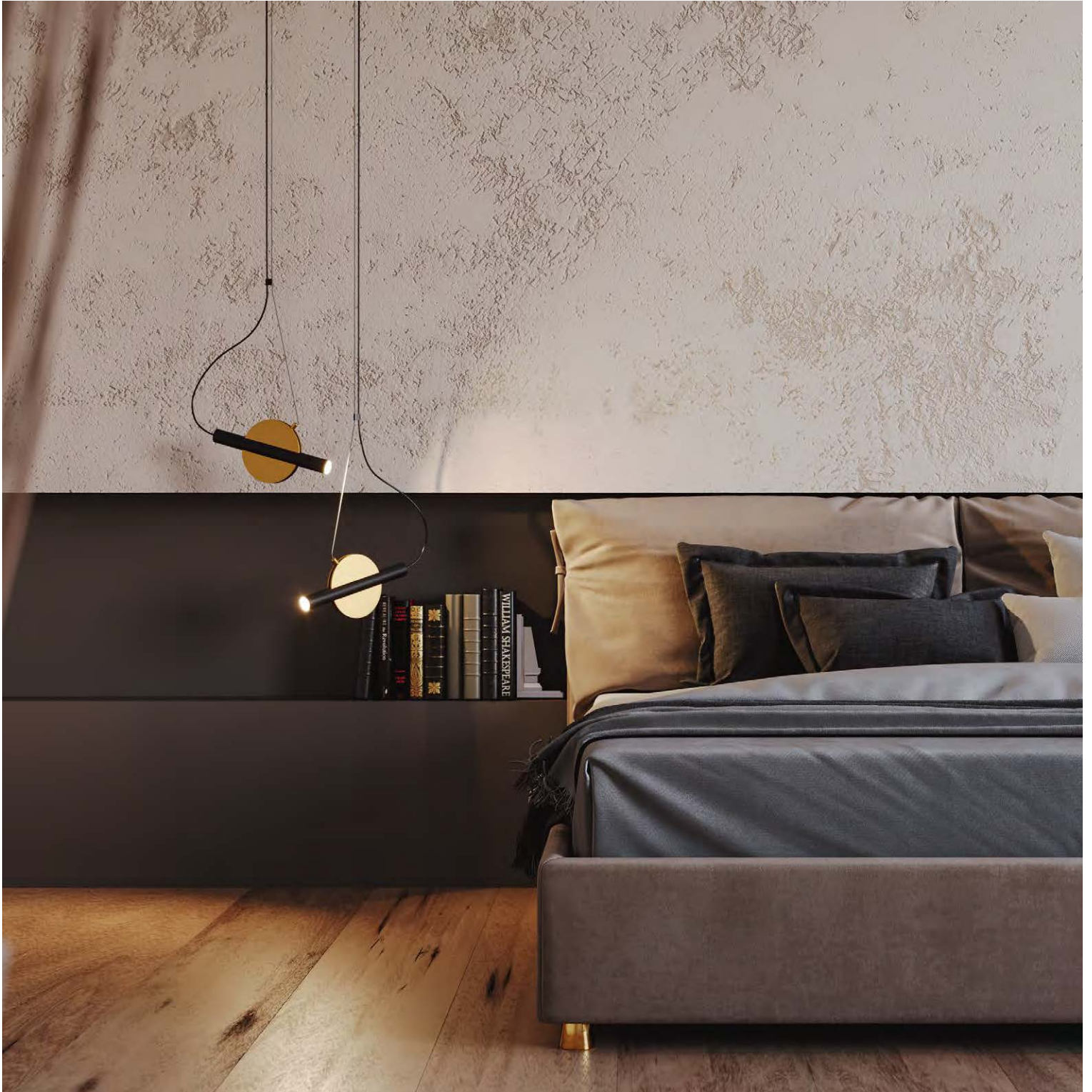

MOD150PL-L5BS3K



Gerhard

B W GR

NEW LED IP20

EN Metal fittings and dome lamp, color - black, white, grey. The shagreen surface prevents appearance of hand marks and dust. The white matte acrylic diffuser transmits light well and prevents glare. Adjustable wire length: up to 3 meters. LED light source. Color temperature - 3000K.

DE Beschläge und Lampenschirm aus Metall, Farben - Schwarz, Weiß, Grau. Shagreenfläche verhindert Handabdrücke und Staub. Weißer matter Acryl-Diffusor ermöglicht eine gute Lichtdurchlässigkeit und verhindert Blendung. Einstellbare Kabellänge - bis 3 Metern. LED-Lichtquelle. Farbtemperatur 3000K.

IT L'armatura e il paralume sono in metallo, i colori sono-nero, bianco, grigio. Superficie shagreen-previene segni di mani e polvere. Il diffusore bianco opaco in acrilico trasmette bene la luce, previene l'effetto accecante. Lunghezza del cavo regolabile e' fino a 3 metri. L'illuminazione a LED. La temperatura del colore e' 3000 K.

FR L'armature et l'abat-jour sont en métal, couleurs - noir, blanc, gris. Surface de chagrin - évite les traces de mains et la poussière. Le diffuseur blanc mat en acrylique transmet bien la lumière et évite l'éblouissement. Longueur de fil réglable - jusqu'à 3 mètres. Source de lumière LED. Température de couleur 3000K.

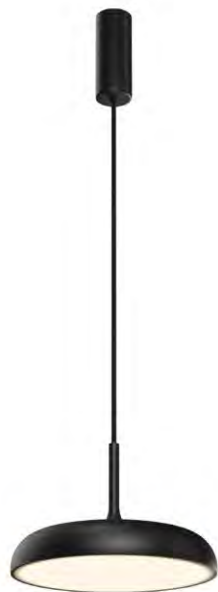

1 ■ ■ ■



2 ■ ■ ■

- 1 ■ **MOD189PL-L12B3K1**
- **MOD189PL-L12W3K1**
- **MOD189PL-L12GR3K1**
- 2 ■ **MOD189PL-L18B3K1**
- **MOD189PL-L18W3K1**
- **MOD189PL-L18GR3K1**

LED 19 W 1000lm
 t° 3000K >80Ra 120°
 IP 20

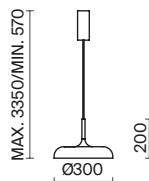

LED 26 W 1400lm
 t° 3000K >80Ra 120°
 IP 20

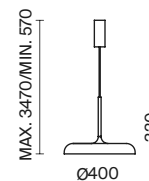



MOD189PL-L12B3K1

Giro

B
BS



EN Black metal fittings. Cone-shaped dome lamps are made of aluminum. Shade – brass. Revolving horns, direction of the light can be changed. Height is adjustable with collapsible central element.

DE Metallbeschläge in Schwarz. Kegelförmige Lampenschirme aus Aluminium. Farbton: Messing. Drehbare Arme, man kann die Lichtrichtung ändern. Durch ein klappbares Mittelstück einstellbare Höhe.

IT Armatura in metallo in nero. Le plafoniere-coni sono realizzate in alluminio. Colore: ottone. Le luci ruotano, si può cambiare la direzione della luce. L'altezza è regolabile con un elemento centrale pieghevole.

FR Armature métallique de couleur noire. Globes sphériques en aluminium. Teinte : laiton. Bras pivotants, possibilité de modifier la direction de la lumière. Hauteur réglable à l'aide d'un élément central pliable.



MOD095PL-10BS

💡 10 × GU10 50 W
IP 20

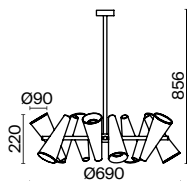

MOD095PL-02BS

💡 2 × GU10 50 W
IP 20

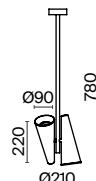

MOD095WL-02BS

💡 2 × GU10 50 W
IP 20

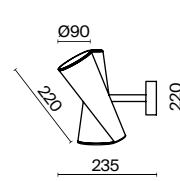

Palette

CFL

IP20



EN Metal fittings combine grey, gold and silver color. Combination of cylindrical shapes in design. Height is adjustable using cable. Light source – lamp with GU10 base.

DE Metallbeschläge mit Kombination von Grau, Gold und Silber. Kombination von zylindrischen Formen im Design. Die Höhe kann mit Kabel eingestellt werden. Lichtquelle: Leuchtmittel mit GU10-Fassung.

IT L'armatura in metallo combina grigio, oro e argento. Combinazione di forme cilindriche nel design. Altezza regolabile con cavo. La sorgente luminosa è una lampadina con attacco GU10.

FR L'armature métallique combine les couleurs grise, dorée et argent. Design avec combinaison des formes cylindriques. Hauteur réglable à l'aide d'un câble. Source de lumière: ampoule à culot GU10.



- 1 **MOD303PL-01CFL2**
MOD303PL-01CFL3

💡 1 x GU10 40W
 IP 20

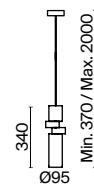

Jack-stone

EN Stainless steel fittings in two shades: nickel and gold. Trendy combination of matte and glossy metal. LED light source with temperature of 3000K.

DE Beschläge aus Edelstahl in zwei Farbtönen: Nickel und Gold. Eine trendige Kombination aus mattem und glänzendem Metall. LED-Lichtquelle mit einer Farbtemperatur von 3000K.

IT Armatura in acciaio inossidabile in due tonalità: nickel e oro. Combinazione alla moda di metallo opaco e lucido. Sorgente luminosa a LED con una temperatura di 3000K.

FR Armature en acier inoxydable en deux teintes : nickel et dorée. Combinaison tendance du métal mat et brillant. Source lumineuse LED avec une température de 3000K.

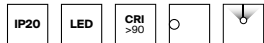

1



2

1 **MOD314WL-L8G3K**
MOD314WL-L8N3K

LED 8W 350lm
t° 3000K >90Ra 120°
IP 20

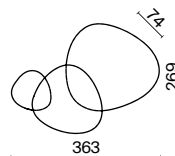

2 **MOD314WL-L13G3K**
MOD314WL-L13N3K

LED 13W 550lm
t° 3000K >90Ra 120°
IP 20

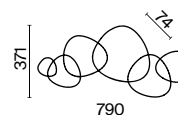



MOD314WL-L13G3K

Lovetann

G

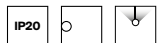

EN Metal frame, color - brushed brass. Decor - openwork discs to match the fittings. Effective lighting design. Trendy floral motifs in design. The lamps of the series are easy to combine, creating compositions. Light source - lamp with E14 base.

DE Metallbeschläge, Farbton: Mattes Messing. Dekor: Durchbrochene Scheiben im Farbton der Beschläge. Eindrucksvolles Lichtmuster. Trendige Blumenmotive im Design. Die Leuchten der Serie lassen sich leicht kombinieren und bilden Kompositionen. Lichtquelle: Ein Leuchtmittel mit E14-Fassung.

IT Corpo in metallo, colore - ottone opaco. Decoro - dischi traforati in tono con i raccordi. Progettazione illuminotecnica impressionante. Motivi floreali alla moda nel design. Le lampade della serie sono facili da combinare, creando composizioni. La sorgente luminosa è una lampadina con attacco E14.

FR Armature en métal, couleur : laiton mat. Éléments décoratifs : disques ajouré dans la teinte de l'armature. Dessin lumineux saisissant. Motifs floraux tendance dans le design. Luminaires de la série facilement combinables en créant une composition. Source de lumière : ampoule à culot E14.



1



2

1 ■ **MOD082WL-01G**

1 x E14 40 W
IP 20

2 ■ **MOD082WL-04G**

4 x E14 40 W
IP 20

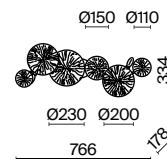
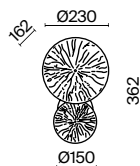



Golden Cage

G

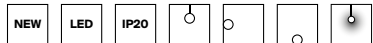

EN Metal fittings, gold color. Decorative handmade wire sphere lamps. Horizontal suspensions in two mount options - surface and hidden ones. The luminous element is a silicone tube with a LED source. Color temperature: 3000K.

DE Metallbeschläge, goldfarben. Dekorative Drahtkugellampenschirme - handgemacht. Horizontale Aufhänger mit zwei Montagemöglichkeiten - Aufsatzmontage oder verdeckte Montage. Das Leuchtelement: Silikonschlauch mit einer LED-Quelle. Farbtemperatur: 3000K

IT L'armatura e' in metallo, colore e' l'oro. I paralumi in forma di sfere decorative in filo metallico sono fatti a mano. Sospensioni orizzontali realizzate in due opzioni di montaggio di quello in testa e di nascosto. L'elemento luminoso è un tubo di silicone con una sorgente a LED. La temperatura di colore e' 3000K.

FR Armature - métal, couleur - or. Les abat-jour-sphères décoratifs en fil sont fabriqués à la main. Suspensions horizontales en deux options de montage - en saillie et caché. L'élément lumineux est un tube en silicone avec une source LED. Température de couleur 3000K.



1 ■ **MOD216FL-L38G3K**

LED 48W 3000lm
t° 3000K >80Ra 360°
IP 20

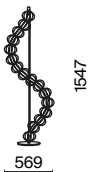

2 ■ **MOD216PL-L10G3K**

LED 17W 1050lm
t° 3000K >80Ra 360°
IP 20

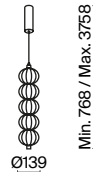

3 ■ **MOD216WL-L10G3K**

LED 17W 1100lm
t° 3000K >80Ra 360°
IP 20

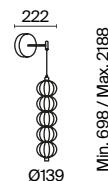



MOD216FL-L38G3K

MOD216PL-L55G3K

4 ■ MOD216PL-L42G3K

5 ■ MOD216PL-L55G3K

LED 37W 1700lm
 t° 3000K >80Ra 360°
 IP 20

LED 107W 6110lm
 t° 3000K >80Ra 360°
 IP 20

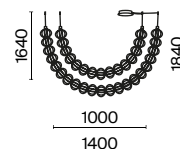
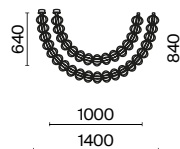

Imaginary

G

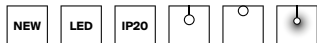

EN Metal fittings, shade – gold. The design incorporates motives of jewelry art. Elegant chains on the lamp body create shimmering highlights. LED light source. Color temperature – 3000K. Adjustable height of the pendant lamp.

DE Metallbeschläge, Farbton - Gold. Motive der Schmuckkunst im Design. Geschmackvolle Ketten am Rahmen der Leuchte schaffen Spiel der Blendung. LED-Lichtquelle. Farbtemperatur - 3000K. Pendelleuchten mit einstellbarer Höhe.

IT L'armatura metallica, il colore è oro. Motivi di gioielleria nel design. Le eleganti catene sul corpo della lampada creano i riflessi traboccanti. L'illuminazione a LED, la temperatura del colore-3000 K. Le lampade a sospensione sono regolabili in altezza.

FR Armature métallique, teinte - or. Motifs de bijouterie dans le design. Des chaînes gracieuses sur le corps de la lampe créent des débordements de reflets. Source de lumière LED. Température de couleur - 3000K. Hauteur de la lampe à suspension réglable.



1



2



3

1 **MOD190PL-L5G3K**

LED 5W 100lm
 t° 3000K >80Ra 120°
 IP 20

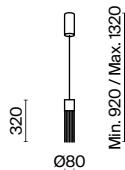

2 **MOD190CL-L18G3K**

LED 18W 750lm
 t° 3000K >80Ra 120°
 IP 20

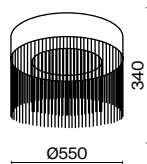

3 **MOD190CL-L36G3K**

LED 36W 1300lm
 t° 3000K >80Ra 120°
 IP 20

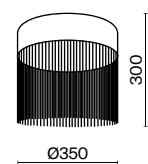



MOD190PL-L5G3K

Mollis

B



EN Fittings and dome lamps of metal, color – black. The original shape of the dome lamp with a smooth contour. The light sources are hidden under the acrylic diffuser.

DE Beschläge und Lampenschirm aus Metall, Farbton: Schwarz. Eine eigenartige Form des Lampenschirms mit einer weichen Kontur. Lichtquellen sind unter dem Acryl-Diffusor verdeckt.

IT Armatura e plafoniera in metallo, colore – nero. Forma originale della plafoniera con un contorno scorrevole. Le sorgenti luminose sono nascoste sotto il diffusore in acrilico.

FR Armature et globes en métal, couleur : noir. Globe à la forme originale au contour lisse. Sources de lumière dissimulée sous le diffuseur en acrylique.

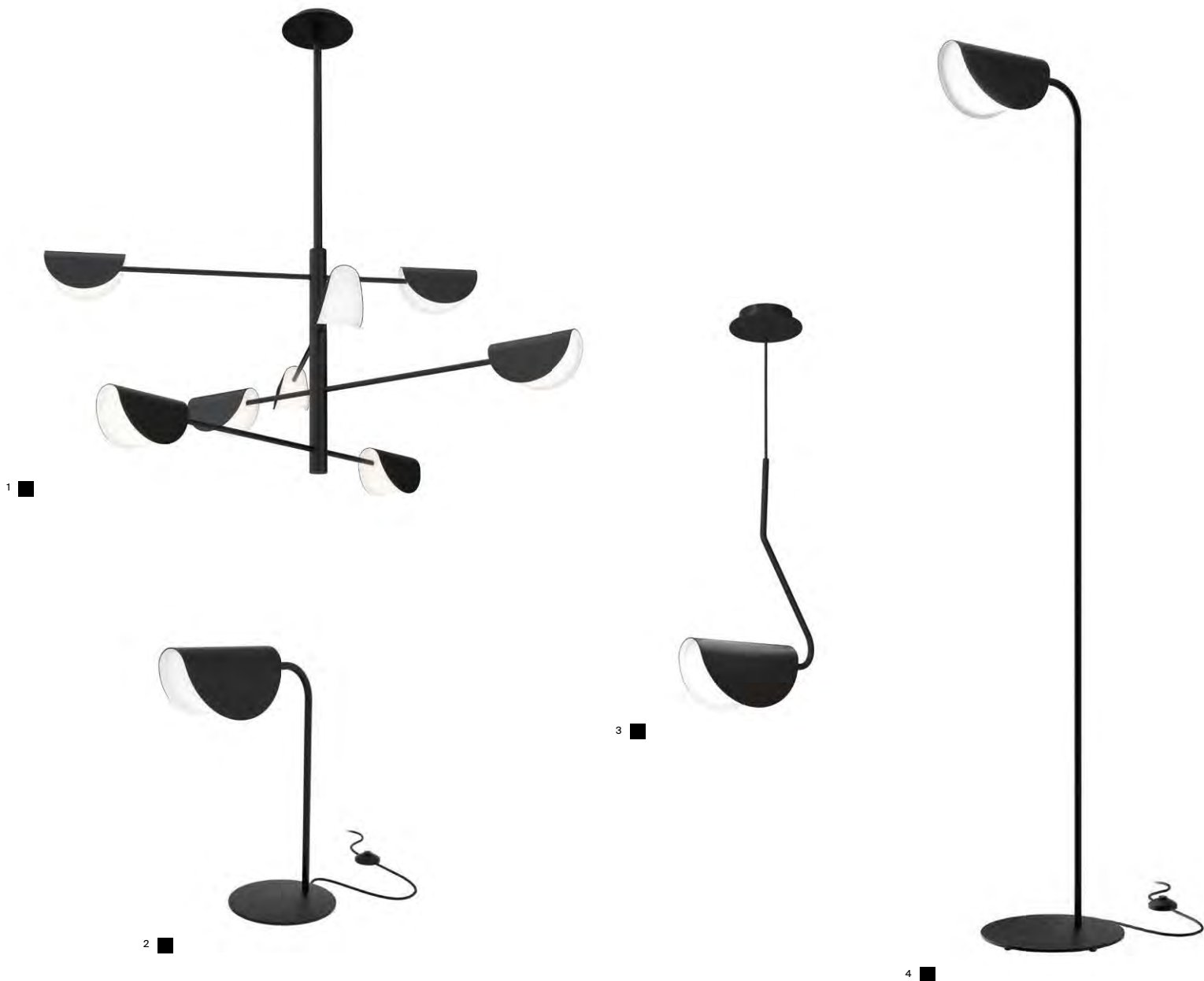

1 ■ MOD126PL-08B

💡 8 x G9 28 W
IP 20

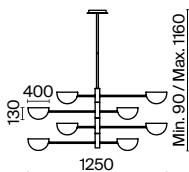

2 ■ MOD126TL-01B

💡 1 x G9 28 W
IP 20

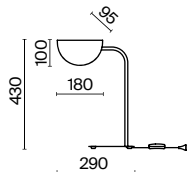

3 ■ MOD126FL-01B

💡 1 x G9 28 W
IP 20

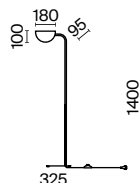

4 ■ MOD126PL-01B

💡 1 x G9 28 W
IP 20

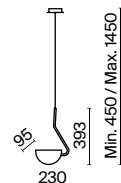



MOD126WL-01B



5 ■



6 ■

5 ■ **MOD126WL-01B**

💡 1 x G9 28 W
IP 20

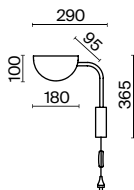

6 ■ **MOD126WL-01B1**

💡 1 x G9 28 W
IP 20

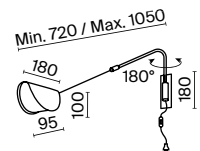

Notta

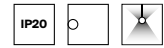
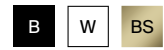

EN Metal fittings in three shades: brass, matte black, matte white. Original geometry in design. Bidirectional light flux: up and down. Compact dimensions. Accent backlight.

DE Metallbeschläge in 3 Farbtönen: Messing, mattes Schwarz und mattes Weiß. Eigenartige Geometrie im Design. Bidirektionaler Lichtstrom: nach oben und nach unten. Kompakte Abmessungen. Akzentbeleuchtung.

IT Armatura metallica in tre tonalità: ottone, nero opaco, bianco opaco. Geometria originale nel design. Flusso luminoso bidirezionale: su e giù. Dimensioni compatte. Illuminazione d'accento.

FR Armature métallique en trois teintes : laiton, noir mat, blanc mat. Design à géométrie originale. Flux lumineux bidirectionnel : vers le haut et vers le bas. Dimensions compactes. Applique d'accentuation.



- 1 **MOD417WL-01W**
 MOD417WL-01B
 MOD417WL-01BS

1 × G9 40 W
 IP 20

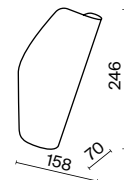



Pixel

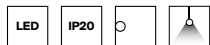

EN Metal fittings. Shades – white, black, brass, combination of black and brass. Swivel dome lamps. Switch button on the lamp. LED light source with a color temperature of 3000K.

DE Metallbeschläge. Farbtöne: Weiß, Schwarz, Messing, eine Kombination aus Schwarz und Messing. Drehbare Lampenschirme. Schaltknopf an der Leuchte. LED-Lichtquelle mit einer Farbtemperatur von 3000K.

IT Armatura in metallo. Tonalità: bianco, nero, ottone, combinazione di nero e ottone. Plafoniere girevoli. Pulsante di selezione sulla lampada. Sorgente luminosa a LED con temperatura di colore di 3000K.

FR Armature en métal. Teintes : blanc, noir, laiton, combinaison de noir et laiton. Globes orientables. Bouton d'allumage sur le luminaire. Source de lumière LED avec une température de couleur de 3000K.



- 1 ■ **MOD421WL-L6B3K**
- **MOD421WL-L6W3K**
- **MOD421WL-L6BS3K**
- **MOD421WL-L6BBS3K**

LED 7W 350lm
 t° 3000K >80Ra 120°
 IP 20

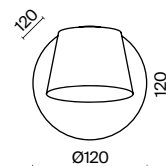



MOD421WL-L6B3K

Plec

G

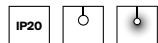

EN Metal fittings in gold color. Spherical dome lamp of white frosted glass and decorative metal element. Adjustable height of the lamp.

DE Metallbeschläge in 2 Farbtönen: Schwarz und Gold. Kugelförmiger Lampenschirm aus weißem Milchglas und einem dekorativen Element aus Metall. Einstellbare Höhe der Leuchte.

IT Armatura metallica in due tonalità: nero e oro. Plafoniera a forma di sfera in vetro opaco bianco e elemento decorativo in metallo. Altezza della lampada regolabile.

FR Armature en métal, en deux teintes : noir et dorée. Globe sphérique en verre blanc mat et élément de décoration en métal. Hauteur du luminaire réglable.



1

1 ■ **P364PL-01G**

1 × E27 60W
IP 20

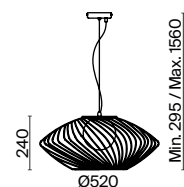

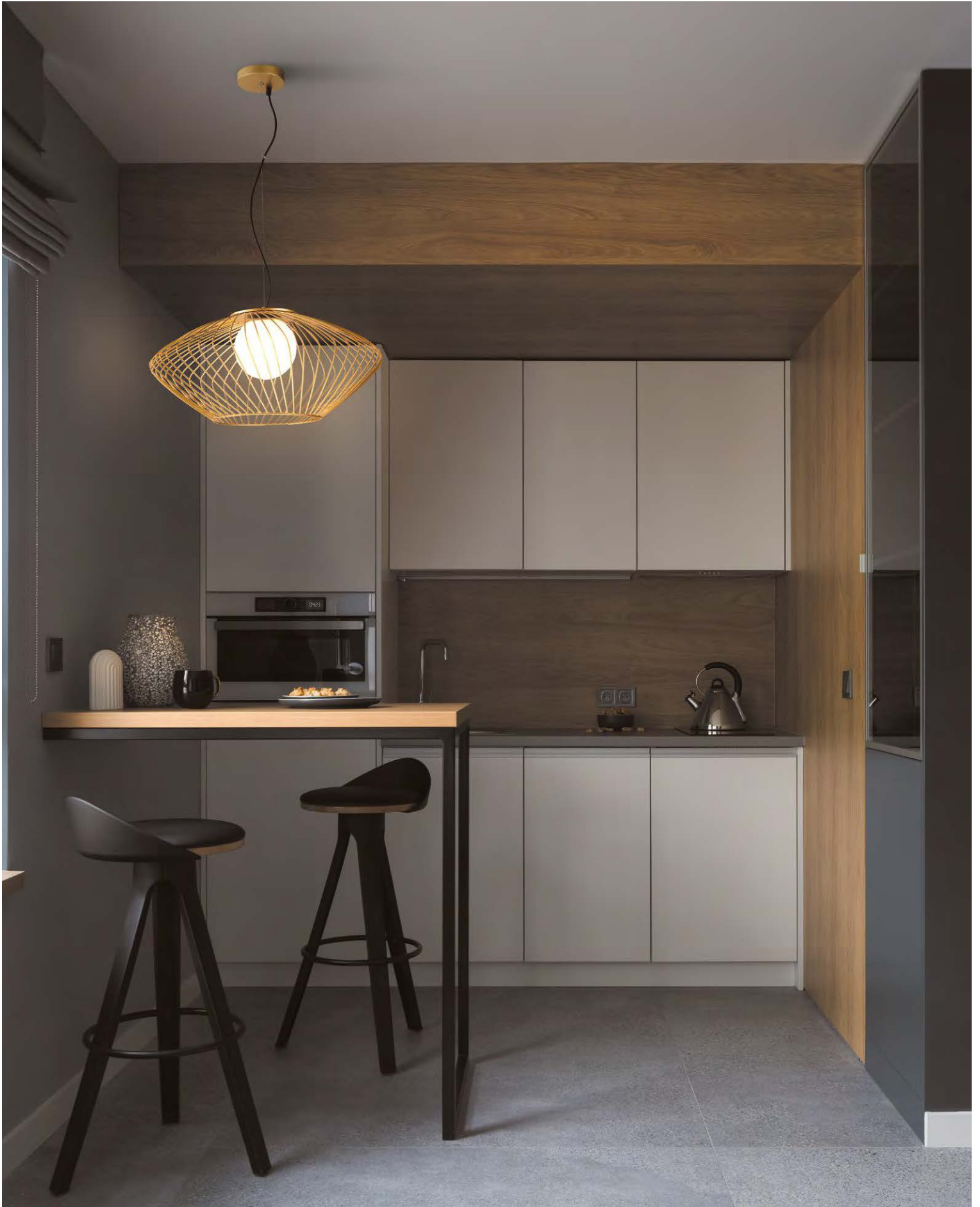

Sonata

BS CH

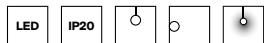

EN Aluminum fittings in two shades: brass, chrome. Soft acrylic diffuser, smooth light distribution. Decorative elements – metal tubes have the same color as the fittings. LED light source, color temperature is 3000K.

DE Aluminiumbeschläge in zwei Farbtönen: Messing, Chrom. Milder Acryl-Diffusor, gleichmäßige Lichtverteilung. Dekor: Metallrohre im Farbton der Beschläge. LED-Lichtquelle mit einer Farbtemperatur von 3000K.

IT Armatura in alluminio in due tonalità: ottone, cromo. Diffusore in acrilico morbido, distribuzione della luce uniforme. Decoro – tubi di metallo in tinta con l'armatura. Sorgente luminosa a LED, temperatura di colore 3000K.

FR Armature en aluminium en deux teintes : laiton, chrome. Diffuseur doux acrylique, diffusion uniforme de la lumière. Élément décoratif : tubes métalliques de la teinte de l'armature. Source de lumière LED, température de couleur : 3000K.



1 **MOD410PL-L12BS3K** **MOD410PL-L12CH3K** 2 **MOD410WL-L12BS3K** **MOD410WL-L12CH3K**

LED 12W 330lm
 t° 3000K >80Ra 120°
 IP 20

LED 12W 330lm
 t° 3000K >80Ra 120°
 IP 20

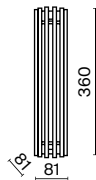
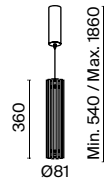



Vesper

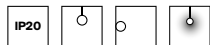

EN Metal fittings, shade – gold. Metal dome lamps are colored in gold from inside. External side in two shade options: black and white. Rotary mechanism, revolving horns.

DE Metallbeschläge in Gold. Lampenschirme aus Metall, auf der Innenseite in Gold lackiert. Außenseite in zwei Farbtönen: Schwarz und Weiß. Schwenkmechanismus, drehbare Arme.

IT Armatura in metallo, tonalità - oro. Le plafoniere in metallo sono verniciate all'interno in colore ottone. Il lato esterno è disponibile in due varianti di colore: bianco e nero. Meccanismo girevole, luci ruotano.

FR Armature en métal, teinte : dorée. L'intérieur des globes métalliques sont teints en couleur dorée. Le côté extérieur existe en deux teintes : noir et blanc. Mécanisme orientable, les bras sont pivotants.



1



2

MOD108PL-14WG
 MOD108PL-14GB

MOD108WL-02WG
 MOD108WL-02GB

14 x E14 40 W
 IP 20

2 x E14 40 W
 IP 20

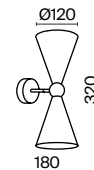
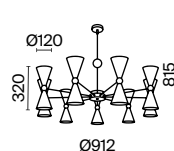



Cipresso

G

IP20



EN Fittings – metal of gold color. Dome lamp – white cast glass. Trendy asymmetry in design. Soft zone light. Light source – lamp with E14 base.

DE Beschläge: Metall in Gold. Lampenschirm: Weißes Gussglas. Trendige Asymmetrie im Design. Weiches Zonenlicht. Lichtquelle: Leuchtmittel mit E14-Fassung.

IT L'armatura: metallo color oro. Plafoniera: vetro colato bianco. Asimmetria alla moda nel design. Luce d'area morbida. La sorgente luminosa è una lampadina con attacco E14.

FR Armature : métal de couleur dorée. Globe en verre coulé blanc. Design asymétrique tendance. Lumière zonale douce. Source de lumière : ampoule à culot E14.



Z014TL-01G

1 ■ Z014TL-01G

💡 1 × E14 40W
IP 20

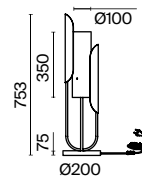

Lantern

W

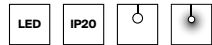

EN Metal fittings of white color. Lampshade of the lamp— screen-printed metal for the effect of sunlight on tree crowns. Lampshade color— white. Wooden decorative element. Adjustable cable length.

DE Metallbeschläge in Weiß. Lampenschirm der Leuchte: Metall mit einem Schablonenmuster für einen Effekt von Sonnenlicht auf den Baumkronen. Farbe des Lampenschirms: Weiß. Dekoratives Element aus Buche. Verstellbare Seillänge.

IT Armatura metallica in bianco. Il paralume è in metallo con un motivo a stencil per l'effetto della luce solare sulle chiome degli alberi. Colore del paralume - bianco. Elemento decorativo in legno. Lunghezza del cavo regolabile.

FR Armature métallique de couleur blanche. Abat-jour du luminaire : métal avec dessin par pochoir pour un effet de lumière du soleil sur les écorces des arbres. Couleur de l'abat-jour : blanc. Élément décoratif en bois. Longueur du câble réglable.

1 1 **MOD029-PL-01-W**

1 x E27 60 W
IP 20

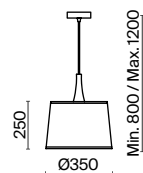

SPECTACULAR MOMENTS OF LIGHT DIVERSITY

In a domain where each detail is birthed from a deep wellspring of affection for the art of illumination, finding one's essence is paramount. Here, every luminary, each symphony of colors and tones, stands as a quintessential embodiment of harmony and aesthetics. Every fixture within my collection transforms into a luminal narrator, articulating untold tales through the language of beams and emotions, communicating moods that transcend the boundaries of words.

The Light Diversity collection draws inspiration from this emotional interplay of light.

Ambience	P. 282
Light stick	P. 284
Halo	P. 286
Curve	P. 294



Ambience

B



EN Aluminium fittings, black color. Round and flat dome lamp, white color. Reflected and diffused light effect for basic lighting. Two diffuser diameters. Adjustable wire length: 3 meters. LED light source. Color temperature - 3000K.

DE Beschläge aus Aluminium, Farbe - Schwarz. Runder und flacher Metalllampenschirm, Farbe - Weiß. Effekt von reflektiertem und diffusen Licht für die Grundbeleuchtung. Zwei Diffusordurchmesser. Die einstellbare Kabellänge - 3 Meter. LED-Lichtquelle. Farbtemperatur 3000K.

IT L'armatura è in alluminio, il colore è nero. Il paralume metallico rotondo e piatto, il colore è bianco. Effetto luce riflessa e diffusa per l'illuminazione principale. Due diametri del diffusore. La lunghezza regolabile dei cavi è di 3 metri. Sorgente luminosa a LED. La temperatura di colore è 3000K.

FR Armature en aluminium, couleur - noir. Abat-jour rond et plat en métal, couleur - blanc. L'effet de la lumière réfléchié et diffusé pour l'éclairage principal. Deux diamètres de diffuseur. Longueur de fil réglable - 3 mètres. Source de lumière LED. Température de couleur 3000K.



1 ■



2 ■

1 ■ **MOD280PL-L30B3K**

LED 30 W 1400lm
 t° 3000K >80Ra 120°
 IP 20

2 ■ **MOD280PL-L23B3K**

LED 23 W 1000lm
 t° 3000K >80Ra 120°
 IP 20

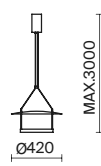
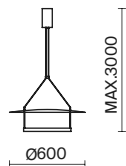



MOD280PL-L30B3K

Light stick

BS B

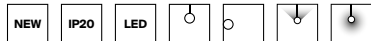

EN Fittings material - aluminium, color - black, brass. Exquisite metal «strings» with the same color as fittings with a built-in light module are covered with a white acrylic diffuser. This series is designed for accent and supplementary lighting. Adjustable length of suspended modules. LED light source. Color temperature - 3000K.

DE Material der Beschläge - Aluminium, Farbe - Schwarz, Messing. Elegante Metall-«Saiten» in der Farbe der Beschläge mit integriertem Lichtmodul werden von einem weißen Acryl-Diffusor abgedeckt. Serie für Akzent- und Zusatzbeleuchtung. Einstellbare Länge der Pendelmodelle. LED-Lichtquelle. Farbtemperatur 3000K.

IT Il materiale dell'armatura è l'alluminio, i colori sono nero, ottone. Le eleganti «corde» metalliche nel colore dell'armatura con un modulo luminoso integrato sono coperte da un diffusore acrilico bianco. Serie per illuminazione d'accento e supplementare. La lunghezza dei modelli sospesi è regolabile. Sorgente luminosa a LED, la temperatura di colore è 3000K.

FR Matériau de l'armature - aluminium, couleur - noir, laiton. D'élégantes «ficelles» métalliques de la couleur de l'armature avec module lumineux intégré sont recouvertes d'un diffuseur en acrylique blanc. Série pour éclairage d'accentuation et supplémentaire. La longueur des modèles suspendus est réglable. Source de lumière LED. Température de couleur 3000K.



1 ■ ■



2 ■ ■



3 ■ ■

1 ■ ■ **MOD236PL-L54BS3K**
■ ■ **MOD236PL-L54B3K**

LED 46W 3350lm
t° 3000K >80Ra 120°
IP 20

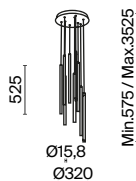

2 ■ ■ **MOD237WL-L6BS3K**
■ ■ **MOD237WL-L6B3K**

LED 7W 500lm
t° 3000K >80Ra 120°
IP 20

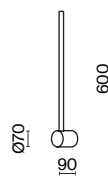

3 ■ ■ **MOD237WL-L11BS3K**
■ ■ **MOD237WL-L11B3K**

LED 10W 750lm
t° 3000K >80Ra 120°
IP 20

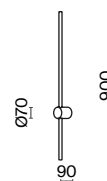



MOD237WL-L11BS3K

Halo

BS B



EN Aluminium fittings. Colors - black, brass. Trendy geometry in design. LED light source with a color temperature of 4000K. Adjustable length of pendant lamps.

DE Material der Beschläge - Aluminium Farben - Schwarz, Messing. Trendige Geometrie im Design. LED-Lichtquelle mit einer Farbtemperatur von 4000K. Einstellbare Höhe der Pendelleuchten.

IT Il materiale dell'armatura è alluminio. I colori sono nero, ottone. Geometria di tendenza nel design. Sorgente luminosa a LED con la temperatura di colore 4000K. L'altezza delle lampade a sospensione è regolabile.

FR Matériau de l'armature - aluminium. Couleurs - noir, laiton. Géométrie tendance dans la conception. Source de lumière LED avec une température de couleur de 4000K. La hauteur des lampes à suspension est réglable.



1 ■



2 ■

1 ■ **MOD005PL-L48BK** 2 ■ **MOD005PL-L48BSK**

LED 48 W 2200lm **LED 48 W 2200lm**
t° 3000-4000K >80Ra 120° **t° 2600-3500K >80Ra 120°**
IP 20 **IP 20**

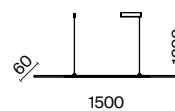
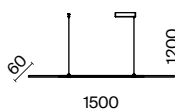



Halo



3 ■ MOD005WL-L46BSK1 4 ■ MOD005WL-L22BSK1 5 ■ MOD005WL-L22BSK

LED 47W 2300lm
 t° 4000K >80Ra 120°
 IP 20



LED 36W 1800lm
 t° 4000K >80Ra 120°
 IP 20

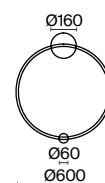

LED 24W 1250lm
 t° 4000K >80Ra 120°
 IP 20

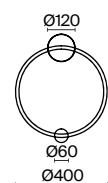



6,7

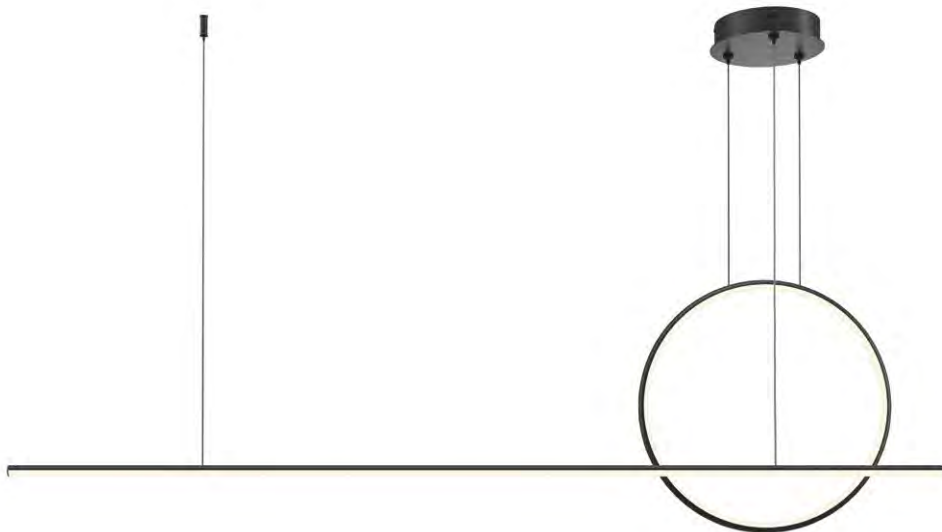

8,9

6 **MOD244PL-L50BSK** 7 **MOD244PL-L50BK** 8 **MOD247PL-L49BSK** 9 **MOD247PL-L49BK**

LED 40W 560lm
 t° 2600-3500K >80Ra 120°
 IP 20

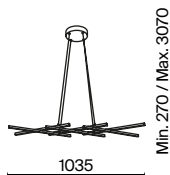

LED 40W 400lm
 t° 3000-4000K >80Ra 120°
 IP 20



LED 40W 2100lm
 t° 2600-3500K >80Ra 120°
 IP 20

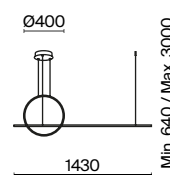

LED 40W 1500lm
 t° 3000-4000K >80Ra 120°
 IP 20

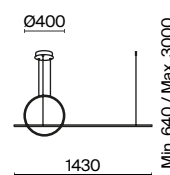

Halo



10 ■ MOD246PL-L24BSK1 11 ■ MOD246PL-L24BK1 12 ■ MOD246PL-L12BSK 13 ■ MOD246PL-L12BK

LED 15W 1100lm
 t° 2600-3500K >80Ra 120°
 IP 20

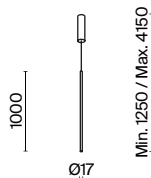

LED 15W 750lm
 t° 3000-4000K >80Ra 120°
 IP 20

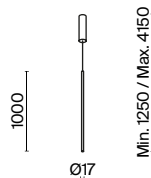

LED 11W 750lm
 t° 2600-3500K >80Ra 120°
 IP 20

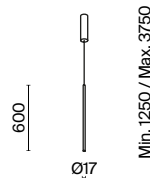

LED 11W 600lm
 t° 3000-4000K >80Ra 120°
 IP 20

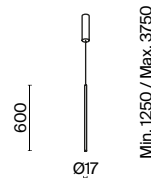



MOD005WL-L46BSK1

MOD005WL-L22BSK

14 ■ MOD248WL-L24BK

15 ■ MOD245WL-L24BSK

16 ■ MOD245WL-L24BK

LED 24W 750lm
 t° 3000-4000K >80Ra 120°
 IP 20

LED 15W 760lm
 t° 2600-3500K >80Ra 120°
 IP 20

LED 15W 520lm
 t° 3000-4000K >80Ra 120°
 IP 20

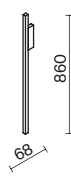
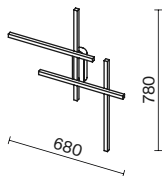

Halo



17, 18 



19, 20 

17  **MOD246PL-L16BSK**

18  **MOD246PL-L16BK**

19  **MOD246PL-L24BSK**

20  **MOD246PL-L24BK**

LED 10W 500lm
 t° 2600-3500K >80Ra 120°
 IP 20

LED 10W 630lm
 t° 3000-4000K >80Ra 120°
 IP 20

LED 16W 1100lm
 t° 2600-3500K >80Ra 120°
 IP 20

LED 16W 800lm
 t° 3000-4000K >80Ra 120°
 IP 20

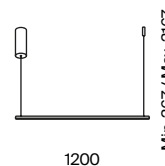
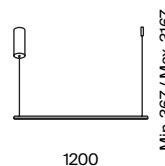
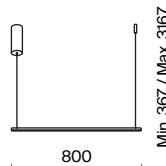
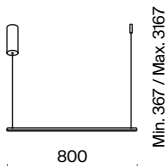



MOD246PL-L12BSK

Curve

BS B

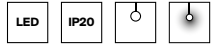

EN Fittings material– aluminum. Shades – black, gold. Trendy minimalistic design, accent silhouette. LED-diffuser with color temperature of 4000K.

DE Material der Beschläge: Aluminium. Farbtöne: Schwarz, Gold. Trendiges minimalistisches Design, akzentuierte Silhouette. LED-Diffusor mit einer Farbtemperatur von 4000K.

IT Materiale dell'armatura - alluminio. Sfumature: nero, oro. Design minimalista alla moda, sagoma d'accento. Diffusore LED con temperatura di colore 4000K.

FR Matériau de l'armature: aluminium. Teintes : noir, dorée. Design minimaliste tendance, silhouette d'accentuation. Diffuseur LED avec une température de couleur de 4000K.



1 ■ ■

1 ■ **MOD156PL-L52B4K**
 ■ **MOD156PL-L52G4K**

LED 42 W 2800lm
 t° 4000K >80Ra 120°
 IP 20

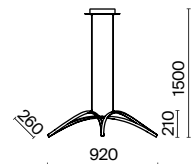



MOD156PL-L52G4K

Curve

BS B

NEW LED IP20

EN Metal fittings, color - black, brass. Rounded silicone light elements with a built-in LED light source along the entire perimeter. An adjustable color temperature range 2600K to 3500K for brass lamps and 3000K to 4000K for black ones. Adjustable cable length. A fancy image of chaotic spiral fragments freely floating in space.

DE Metallbeschläge, Farben - Schwarz, Messing. Abgerundete Silikon-Leuchtelemente mit rundum integrierter LED-Lichtquelle. Einstellbarer Farbtemperaturbereich 2600K-3500K für Leuchten in Messing und 3000K-4000K in Schwarz. Einstellbare Länge von Seilen. Phantasiegestalt von chaotischen, frei im Raum schwebenden Fragmenten von Spiralen.

IT L'armatura è in metallo, i colori sono nero, ottone. Elementi luminosi arrotondati in silicone con sorgente luminosa a LED integrata tutt'intorno. La gamma di colore regolabile della temperature di colore è 2600K-3500K per le lampade in ottone e 3000K-4000K per quelle di colore nero. La lunghezza dei cavi è regolabile. Immagine fantasy di frammenti caotici di spirali che fluttuano liberamente nello spazio.

FR Armature métallique, couleurs - noir, laiton. Éléments lumineux arrondis en silicone avec une source lumineuse LED intégrée sur tout le périmètre. Plage de température de couleur réglable 2600K-3500K pour les lampes en laiton et 3000K-4000K pour les lampes noires. Longueur de câbles réglable. Une image fantastique de fragments chaotiques de spirales flottant librement dans l'espace.



1,2 ■ ■



3,4 ■ ■

1 ■ **MOD242PL-L33BK** 2 ■ **MOD242PL-L33BSK** 3 ■ **MOD243PL-L18BK** 4 ■ **MOD243PL-L18BSK**

LED 31W 1600lm
t° 3000-4000K >80Ra 120°
IP 20

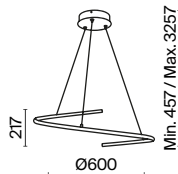

LED 31W 2100lm
t° 2600-3500K >80Ra 120°
IP 20

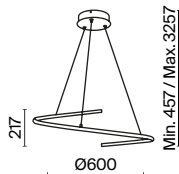

LED 15W 800lm
t° 3000-4000K >80Ra 120°
IP 20

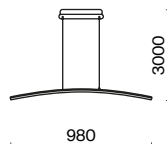

LED 15W 1150lm
t° 2600-3500K >80Ra 120°
IP 20

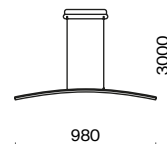



Anillo

CH G

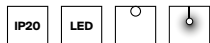

EN Metal fittings in two colors: chrome and gold. LED strip is enclosed in an acrylic diffuser. Color temperature is 3000-3500K. Reflective surface at diffuser attachment point creates light loop effect.

DE Metallbeschläge in 2 Farbtönen: Chrom und Gold. Lichtband in Acryl-Diffusor eingeschlossen. Farbtemperatur 3000-3500K. Die lichtreflektierende Oberfläche am Befestigungspunkt des Diffusors erzeugt einen Lichtschleifeneffekt.

IT Armatura in metallo in due tonalità: cromo e oro. La striscia LED è racchiusa in un diffusore in acrilico. Temperatura di colore 3000-3500K. La superficie riflettente nel punto di attacco del diffusore crea l'effetto di un anello luminoso.

FR Armature en métal en deux teintes : chrome et dorée. Ruban LED incrusté dans le diffuseur acrylique. Température de couleur : 3000-3500K. La surface réfléchissante au point de fixation du diffuseur crée l'effet d'une boucle lumineuse.



1



2

1 **MOD315CL-L25CH3K** 2 **MOD315CL-L25G3K**

LED 25W 1400lm
 t° 3500K >80Ra 120°
 IP 20

LED 25W 1400lm
 t° 3000K >80Ra 120°
 IP 20

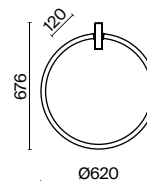
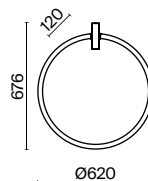



MOD315CL-L25G3K

Axis

W B G

NEW IP20 LED

EN Fittings material— aluminum, color – gold. Wall models with fittings in three shades: brass, black, white. Tube-shaped dome lamps made of matte acrylic distribute light evenly. Trendy asymmetry in chandelier design. LED light sources with a color temperature of 3000K.

DE Aluminiumbeschläge, Farbton: Gold. Wandmodelle in drei Farbtönen: Gold, Schwarz, Weiß. Röhrenförmige Lampenschirme aus mattem Acryl verteilen das Licht gleichmäßig. Trendige Asymmetrie im Kronleuchten-Design. LED-Lichtquellen mit einer Farbtemperatur von 3000K.

IT Materiale dell'armatura - alluminio, colore - oro. Modelli da parete in tre tonalità di armatura: ottone, nero, bianco. I tubi in acrilico opaco distribuiscono la luce in modo uniforme. Asimmetria alla moda nel design dei lampadari. Sorgenti luminose a LED con temperatura di colore di 3000K.

FR Matériau de l'armature: aluminium, couleur : dorée. Modèles muraux en trois teintes d'armature : laiton, noir, blanc. Les globes-tubes en acrylique mat diffusent uniformément la lumière. Design tendance de l'asymétrie des lustres. Sources de lumière LED avec une température de couleur de 3000K.

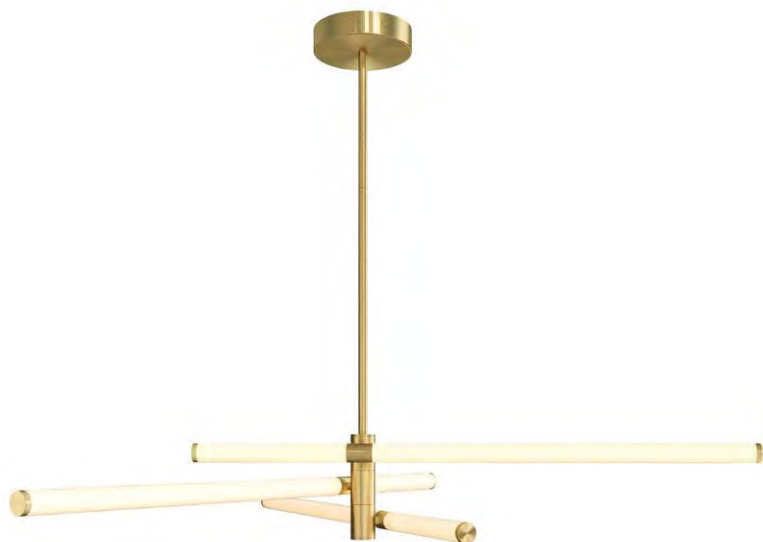

1



2



3



4

1 **MOD106CL-L40G3K**

2 **MOD106PL-L28G3K**

3 **MOD106WL-L10G3K**

4 **MOD106WL-L16W3K**
MOD106WL-L16B3K
MOD106WL-L16G3K

LED 40W 3600lm
 t° 3000K >80Ra 360°
 IP 20

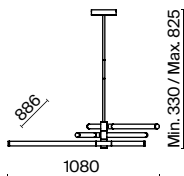

LED 28W 3000lm
 t° 3000K >80Ra 360°
 IP 20

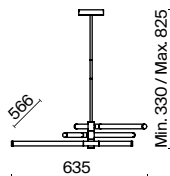

LED 16W 1400lm
 t° 3000K >80Ra 360°
 IP 20

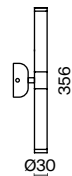

LED 16W 1400lm
 t° 3000K >80Ra 360°
 IP 20

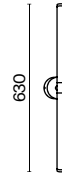



MOD106WL-L16B3K

Cascade

EN Fittings material – aluminum. Shades – black, brass. Trendy design – lines of light. LED source with color temperature of 3000-4000K.

DE Material der Beschläge: Aluminium. Farbtöne: Schwarz, Messing. Trenddesign: Lichtlinien. LED Lichtquelle mit einer Farbtemperatur von 3000-4000K.

IT Materiale dell'armatura - alluminio. Tonalità: nero, ottone. Design alla moda: linee di luce. Sorgente LED con temperatura di colore 3000-4000K.

FR Matériau de l'armature : aluminium. Teintes : noir, laiton. Design tendance : lignes de lumière. Source LED avec une température de couleur de 3000-4000K.

B BS

LED IP20



1



2



3

1 ■ MOD132PL-L6BSK

LED 6 W 700lm
 t° 2600-3500K >80Ra 120°
 IP 20

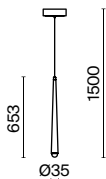

2 ■ MOD132PL-L18BSK

LED 19 W 1550lm
 t° 2600-3500K >80Ra 120°
 IP 20

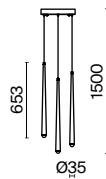

3 ■ MOD132PL-L30BSK

LED 31 W 2550lm
 t° 2600-3500K >80Ra 120°
 IP 20

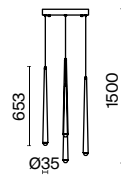



MOD132PL-L18BSK

Cascade



4 ■



5 ■



6 ■

4 ■ **MOD132PL-L6BK**

LED 6W 400lm
 t° 3000-4000K >80Ra 120°
 IP 20

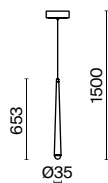

5 ■ **MOD132PL-L18BK**

LED 19W 1400lm
 t° 3000-4000K >80Ra 120°
 IP 20

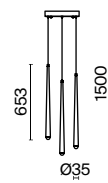

6 ■ **MOD132PL-L30BK**

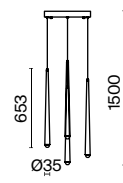

LED 31W 2400lm
 t° 3000-4000K >80Ra 120°
 IP 20





Estudo

B **W**

LED IP20   

EN Body material— metal, color — black, white. Decorative backlight of the base. Rotating cylinder-shaped dome lamp used for light direction adjustment. LED light source.

DE Rahmenmaterial: Metall, Farbton: Schwarz, Weiß. Dekorative Beleuchtung im Sockel. Drehbarer zylinderförmiger Lampenschirm zum Einstellen der Lichtrichtung. LED-Lichtquelle.

IT Materiale del corpo - metallo, colore - nero, bianca. Illuminazione decorativa del piede. Plafoniera a cilindro rotante per regolare la direzione della luce. Sorgente luminosa a LED.

FR Matériau du corps : métal, couleur : noir, blanche. Pendentifs décoratifs de la base. Globe cylindrique pivotant pour le réglage de l'orientation de la lumière. Source de lumière LED.

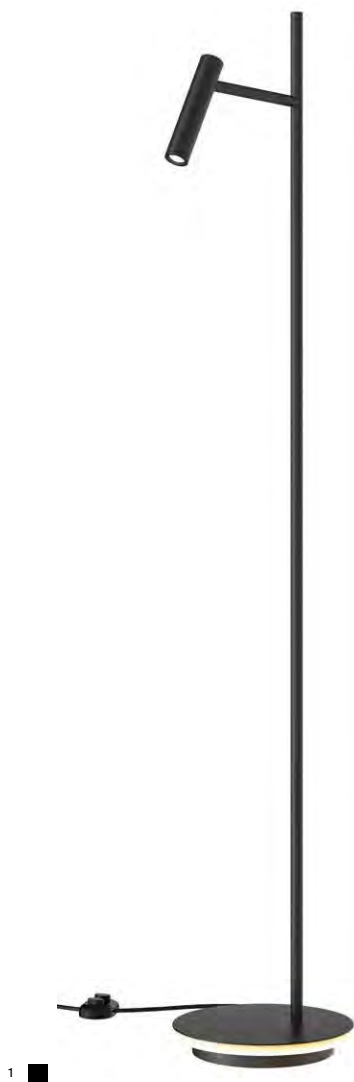

1 ■ **Z010FL-L8B3K**

2 ■ **Z010TL-L8B3K**
□ **Z010TL-L8W3K**

LED 11W 730lm
t° 3000K >80Ra 90°
IP 20

LED 9W 589lm
t° 3000K >80Ra 90°
IP 20

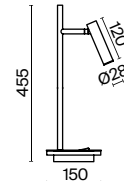



Z010FL-L8B3K

Fad

MB B

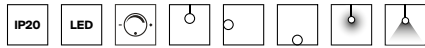

EN Fittings and dome lamps of metal. Shades – matte black and black. Dome lamps rotate 340° horizontally and 90° vertically. Matte acrylic diffuser. Integrated LED module. Switch of the wall lamp and table lamp with dimmer.

DE Beschläge und Lampenschirme aus Metall. Farbtöne: Mattes Schwarz und Schwarz. Lampenschirme drehen sich horizontal um 340° und vertikal um 90°. Matted Acryl-Diffusor. Integriertes LED-Modul. Schalter für Wandleuchte und Tischleuchte mit einem Dimmer.

IT Armatura e plafoniere in metallo. Colori – nero opaco e nero. Le plafoniere ruotano di 340° in orizzontale e di 90° in verticale. Diffusore in acrilico opaco. Modulo LED integrato. Interruttore dell'appliche e della lampada da tavolo con dimmer.

FR Armature et globes en métal. Teintes : noir mat et noir. Les globes pivotent sur 340° à l'horizontale et 90° sur le plan vertical. Diffuseur acrylique mat. Module intégré LED. Interrupteur de l'applique et de la lampe de bureau avec gradateur.



1 ■ **MOD070FL-L12B3K**

LED 12W 1000lm
t° 3000K >80Ra 120°
IP 20

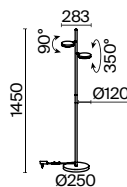

2 ■ **MOD070WL-L6B3K**

LED 6W 550lm
t° 3000K >80Ra 120°
IP 20

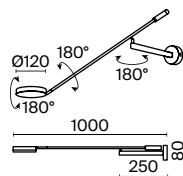

3 ■ **MOD070WL-L8B3K**

LED 6W 550lm
t° 3000K >80Ra 120°
IP 20

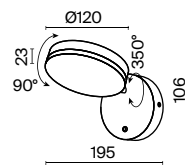



4 ■

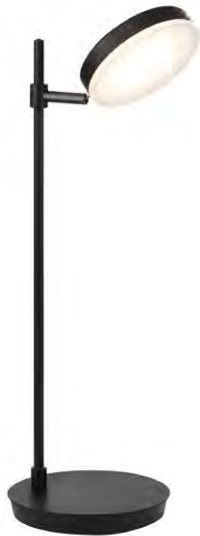

5 ■



6 ■

4 ■ **MOD070PL-L63B3K**

LED 63W 2800lm
 t° 3000K >80Ra 120°
 IP 20

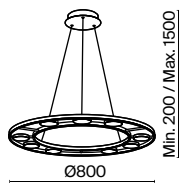

5 ■ **MOD070TL-L8B3K**

LED 8W 418lm
 t° 3000K >80Ra 120°
 IP 20



6 ■ **MOD070PL-L18B3K**

LED 18W 1100lm
 t° 3000K >80Ra 120°
 IP 20

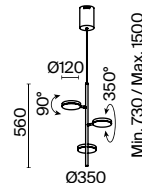

Fad



7 ■



8 ■

7 ■ **MOD070PL-L48B3K**

LED 48 W 2200lm
 t° 3000K >80Ra 120°
 IP 20

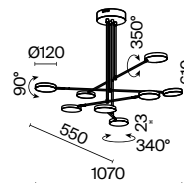

8 ■ **MOD070PL-L38B3K**

LED 36 W 2100lm
 t° 3000K >80Ra 120°
 IP 20

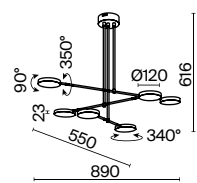



MOD070WL-L6B3K

Flow

B BS



EN Metal fittings. Shades – matte black, brass. Dimmable and color temperature adjustment function (3000K-6000K). LED light source.

DE Metallbeschläge. Farbtöne: Mattes Schwarz, Messing. Dimmfunktion und Farbtemperatureinstellung (3000K-6000K). LED-Lichtquelle.

IT Armatura in metallo. Plafoniere: nero opaco, ottone. Funzione di regolazione della luminosità e regolazione della temperatura del colore (3000K-6000K). Sorgente luminosa a LED.

FR Armature en métal. Teintes : noir mat, laiton. Fonction de graduation et de réglage de la température de couleur (3000K - 6000K). Source de lumière LED.

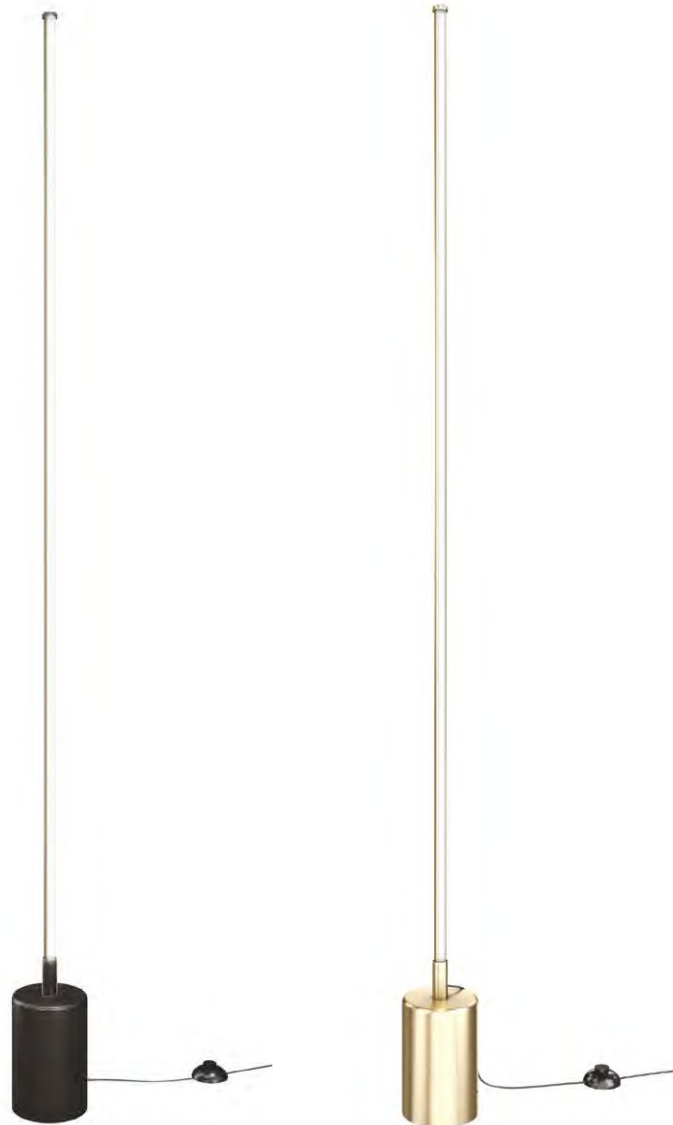

1 ■ ■

1 ■ **MOD147FL-L20BK1**
 ■ **MOD147FL-L20BSK1**

LED 25W 2600lm
 t° 3000-6000K >80Ra 120°
 IP 20

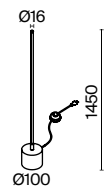



MOD147FL-L20BK1

Glint

EN Fittings material— aluminum. Shades — brass, black. Minimalistic design. Trendy effect of soaring. LED light source. Color temperature is 3000K.

DE Material der Beschläge: Aluminium. Farbtöne: Messing, Schwarz. Minimalistisches Design. Trendeffekt des Schwebens. LED-Lichtquelle. Farbtemperatur 3000K.

IT Materiale dell'armatura - alluminio. Tonalità: ottone, nero. Design minimalista. Effetto galleggiamento alla moda. Sorgente luminosa a LED. Temperatura di colore 3000K.

FR Matériau de l'armature : aluminium. Teintes : laiton, noir. Design minimaliste. Effet de lévitation tendance. Source de lumière LED. Température de couleur : 3000K.

BS B

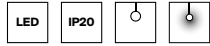

1,2 ■ ■



3,4 ■ ■

- 1 ■ **MOD072PL-L28BS3K1** 2 ■ **MOD072PL-L28B3K1** 3 ■ **MOD072PL-L36BSK1** 4 ■ **MOD072PL-L36B3K1**

LED 24 W 1500lm
t° 3000K >80Ra 120°
IP 20

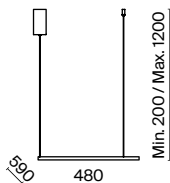

LED 24 W 1100lm
t° 3000K >80Ra 120°
IP 20

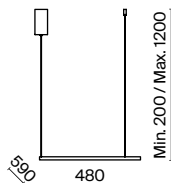

LED 36 W 2200lm
t° 3000K >80Ra 120°
IP 20

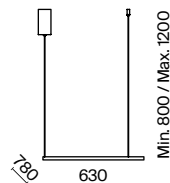

LED 36 W 1700lm
t° 3000K >80Ra 120°
IP 20

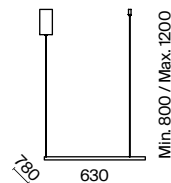



MOD072PL-L28BS3K

Motion

B **W**

NEW **LED** **IP20**  

EN Aluminium fittings, colors: black, white. LED light source, color temperature: 3000K. A minimalistic design with motion sensor control. Functions: turning on/off and dimming with a slight movement of the hand under the lamp. A 3-meter adjustable wire, suited for rooms with high ceilings.

DE Material der Beschläge - Aluminium, Farben - Schwarz, Weiß. LED-Lichtquelle, Farbtemperatur - 3000K. Minimalistisches Design mit Bewegungssensor-Steuerung. Funktionen: Einschalten, Ausschalten und Dimmen durch einfache Handbewegung unter der Leuchte. Verstellbares Kabel 3m, geeignet für Räume mit hohen Decken.

IT Il materiale dell'armatura è l'alluminio, i colori sono nero, bianco. La sorgente luminosa a LED, la temperatura di colore è 3000K. Il design minimalista con il controllo del sensore di movimento. Le caratteristiche tecniche: l'accensione, lo spegnimento e l'oscuramento con un semplice movimento della mano sotto una lampada. Il cavo regolabile da 3 metri è adatto per gli ambienti con soffitti alti.

FR Matériau de l'armature - aluminium, couleurs - noir, blanc. Source de lumière LED, température de couleur : 3000K. Conception minimaliste avec contrôle par détecteur de mouvement. Fonctions : activation, désactivation et gradateur d'un léger mouvement de la main sous la luminaire. Le fil réglable de 3 mètres, adapté aux pièces avec de hauts plafonds.



1



2

1 **MOD276PL-L40B3K**

2 **MOD276PL-L40W3K**

LED 40W 2000lm
t° 3000K >80Ra 120°
IP 20

LED 40W 2500lm
t° 3000K >80Ra 120°
IP 20

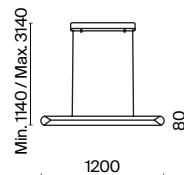
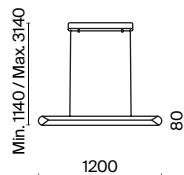



Node

G

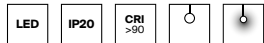

EN Fittings: metal. Color: gold. The position of the light rings is adjustable. LED light source is covered with matte diffuser. Color temperature is 3000K. High color rendering index is 90Ra.

DE Metallbeschläge, Farbton - Gold. Einstellbare Position der Lichtringe. LED-Lichtquelle, von einem matten Diffusor abgedeckt. Farbtemperatur 3000K. Hoher Farbwiedergabeindex von 90Ra.

IT Il materiale dell'armatura è il metallo. La tonalità è l'oro. La posizione degli anelli luminosi è regolabile. La sorgente luminosa a LED è ricoperta da un diffusore opaco. Temperatura di colore 3000K. Alto indice di resa cromatica 90Ra.

FR Matériau de l'armature - métal. Teinte - noir. Disposition des anneaux lumineux réglable. Source de lumière LED fermée par diffuseur mat. Température de couleur : 3 000 K. Fort indice de rendu de couleur : 90 Ra.



1



2

1 ■ **MOD165PL-L40G3K**

LED 40 W 2600lm
 t° 3000K >90Ra 180°
 IP 20

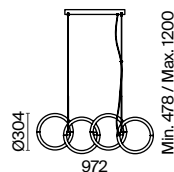

2 ■ **MOD165PL-L18G3K**

LED 18 W 1200lm
 t° 3000K >90Ra 180°
 IP 20

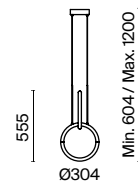



MOD165PL-L18G3K

Peso

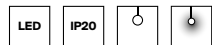

EN Metal body. The light source is a lamp with a E27 base (not included).

DE Metallrahmen. Lichtquelle: Ein Leuchtmittel mit einer Fassung E27 (nicht im Lieferumfang enthalten).

IT Corpo in metallo. La sorgente luminosa è una lampadina con attacco E27 (non inclusa).

FR Corps métallique. Source de lumière: ampoule à culot GU10 (non comprise dans le lot).



- 1 **P080PL-01B**
- P080PL-01W**

1 × E27 60 W
IP 20

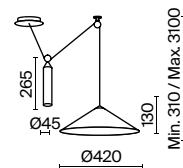



Nuance

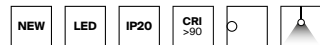

EN Fittings - aluminum, color - black, black + brass, white + black, white + brass. Functional decor: a metal rod enables the light element direction to be unfolded and adjusted. LED light source, color temperature - 3000K.

DE Beschläge - Aluminium, Farbe - Schwarz, Schwarz + Messing, Weiß + Schwarz, Weiß + Messing. Funktionelles Dekor - Metallstange ermöglicht das Öffnen und Verstellen der Richtung des Lichtelements. LED-Lichtquelle - Farbtemperatur 3000K.

IT L'armatura è in alluminio, i colori sono nero, nero + ottone, bianco + nero, bianco + ottone. Arredamento funzionale - e' lo stelo in metallo consente di rivelare e regolare la direzione dell'elemento luminoso. L'illuminazione a LED, la temperatura del colore e' 3000K

FR Armature - aluminium, couleur - noir, noir + laiton, blanc + noir, blanc + laiton. Décor fonctionnel - une tige métallique permet d'ouvrir et d'ajuster la direction de l'élément lumineux. Source de lumière LED - température de couleur 3000K.



- 1 ■ **MOD180WL-L4B3K**
- **MOD180WL-L4B3K1**
- **MOD180WL-L4W3K**
- **MOD180WL-L4W3K1**

LED 4W 200lm
t° 3000K >90Ra 24°
IP 20

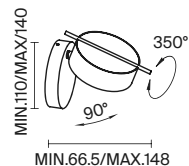



MOD18OWL-L4B3K

Origami

B W

LED IP20

EN Fittings material— metal. Shades – white, black. Portable design for light level and design adjustment. Safe live cables. LED light sources with color temperature of 4000K.

DE Metallbeschläge, Farbtöne: Weiß, Schwarz. Bewegliche Konstruktion zur Anpassung der Beleuchtungsintensität und des Designs. Sichere Stromseile. LED-Lichtquellen mit einer Farbtemperatur von 4000K.

IT Materiale dell'armatura - metallo. Tonalità: bianco, nero. Struttura snodata per la regolazione del livello di luce e del design. Conduttori sicuri. Sorgenti luminose a LED con temperatura di colore di 4000K.

FR Matériau de l'armature : métal. Teintes: blanc, noir. Construction mobile pour le réglage du niveau d'éclairage et du design. Câbles d'alimentation électriques sécurisés. Sources de lumière LED avec une température de couleur de 4000K.



1 ■



2 □

1 ■ **MOD163PL-L38B4K1**

2 □ **MOD163PL-L38W4K1**

LED 46 W 2300lm
 t° 4000K >80Ra 120°
 IP 20

LED 46 W 1000lm
 t° 4000K >80Ra 120°
 IP 20

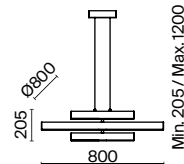
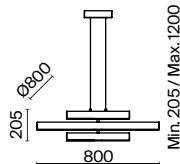



MOD163PL-L38B4K1

Ray

B

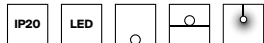

EN Fittings material – metal, color – black. Dome lamp – matte acrylic and aluminum to match fittings. Light source – SMD-LEDs. Color temperature is 3000K. Adjustable height.

DE Metallbeschläge, Farbton: Schwarz. Lampenschirm: Mattes Acryl und Aluminium im Farbton der Beschläge. Lichtquelle: SMD-LEDs. Farbtemperatur 3000K. Einstellbare Höhe.

IT Materiale dell'armatura - metallo, colore - nero. Plafoniere - acrilico opaco e alluminio in tinta con l'armatura. La sorgente luminosa è LED SMD. Temperatura di colore 3000K. Altezza regolabile.

FR Matériau de l'armature : métal, couleur : noir. Globe: acrylique mat et aluminium dans la teinte de l'armature. Source de lumière : LED SMD. Température de couleur : 3000K. Hauteur réglable.



1 ■



2 ■

■ **Z012TL-L8B3K**

LED 8 W 750lm
 t° 3000K >80Ra 270°
 IP 20

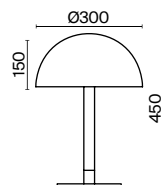

■ **Z012FL-L18B3K**

LED 18 W 2100lm
 t° 3000K >80Ra 360°
 IP 20

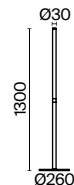



Z012TL-L8B3K

Renaissance

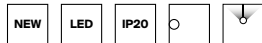
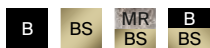

EN Two options of the body base. Metal, colors: black and satin brass. Marble, colors: black and grey. A metal tube lamp with a hidden diffuser. The series embodies Renaissance aesthetics, skilfully matching color palettes, shapes and materials typical of that period. LED light source. Color temperature: 3000K.

DE Zwei Optionen des Rahmensockels. Metall, Farben - Schwarz und satiniertes Messing. Marmor, Farben - Schwarz und Grau. Rohr-Lampenschirm aus Metall mit verstecktem Diffusor. Die Serie spiegelt die ästhetischen Gefühle der Renaissance wider und kombiniert kunstvoll Farbpaletten, Formen und Materialien, die für diese Zeit charakteristisch sind. LED-Lichtquelle. Farbtemperatur - 3000K.

IT Due opzioni per la base della custodia. Metallico, i colori sono nero e ottone satinato. Marmo, i colori sono nero e grigio. Il paralume e' un tubo di metallo con il diffusore nascosto. La serie riflette i sentimenti estetici rinascimentali, combinando abilmente le tavolozze di colori, le forme ed i materiali caratteristici del Rinascimento. La sorgente luminosa a LED. La temperatura di colore e' 3000K.

FR Deux options de base du corps. Métal, couleurs - noir et laiton satiné. Marbre, couleurs - noir et gris. Abat-jour - tube en métal avec un diffuseur caché. La série reflète les sensibilités esthétiques de la Renaissance, combinant superbement les palettes de couleurs, les formes et les matériaux caractéristiques de l'époque. Source de lumière LED. Température de couleur - 3000K.



1 ■ MOD256WL-L5BS3K1 2 ■ MOD256WL-L5BS3K2 3 ■ MOD256WL-L5BS3K3 4 ■ MOD256WL-L5B3K

LED 6W 170lm
t° 3000K >80Ra 30°
IP 20

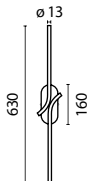

LED 6W 170lm
t° 3000K >80Ra 30°
IP 20

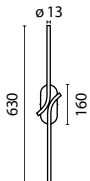

LED 6W 170lm
t° 3000K >80Ra 30°
IP 20

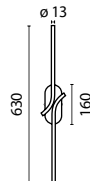

LED 6W 170lm
t° 3000K >80Ra 30°
IP 20

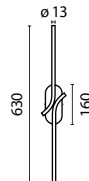



MOD256WL-L5BS3K3

Rida

G W

NEW IP20 LED

EN Metal fittings, color – white. Matte acrylic hides integrated LED sources. Geometric design: the design consists of rectangles superimposed on each other.

DE Metallbeschläge, Farbtöne: Weiß. Mattes Acryl verbirgt integrierte LED-Quellen. Geometrisches Design: die Konstruktion besteht aus übereinander angeordneten Rechtecken.

IT Armatura in metallo, colore - bianca. L'acrilico opaco nasconde le sorgenti LED integrate. Disegno geometrico: la struttura è costituita da rettangoli sovrapposti l'uno all'altro.



FR Armature métallique, couleur : blanche. L'acrylique mat dissimule les sources LED intégrées. Design géométrique : la construction est composée de rectangles superposées les uns sur les autres.



12  



3 

1  **MOD015CL-L80WK** 2  **MOD015CL-L80GK** 3  **MOD015CL-L80W**

LED 78 W 4300lm
t° 3000-4000K >80Ra 120°
IP 20

LED 78 W 4300lm
t° 2600-3500K >80Ra 120°
IP 20

LED 80 W 4100lm
t° 3000K >80Ra 360°
IP 20

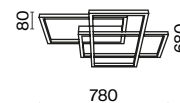
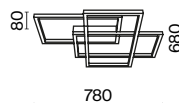
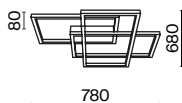

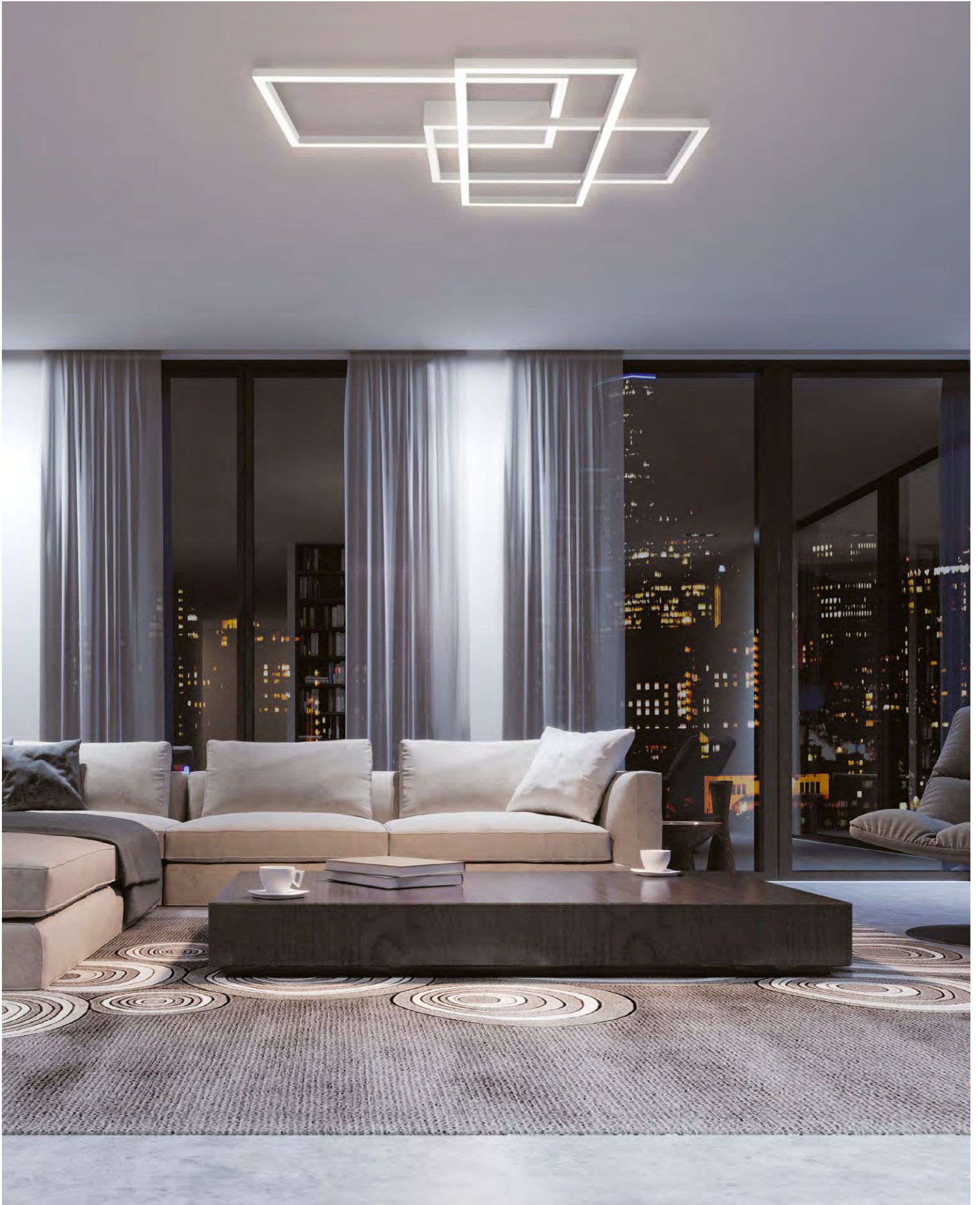

MOD015CL-L80W

Saturno

EN Fittings material— stainless steel, color – brass. Integrated LED light source. Neutral color temperature is 4000K. Trendy circle shape. The series includes pendant models of various diameters.

DE Material der Beschläge: Edelstahl, Farbton: Messing. Integrierte LED-Lichtquelle. Neutrale Farbtemperatur 4000K. Trendige Kreisform. Die Serie umfasst Pendelmodelle mit unterschiedlichen Durchmessern.

IT Materiale dell'armatura - acciaio inossidabile, colore - ottone. Sorgente luminosa a LED integrata. Temperatura di colore neutro 4000K. Forma circolare alla moda. La serie comprende modelli a sospensione di vari diametri.

FR Matériau de l'armature : acier inoxydable, couleur: laiton. Source de lumière LED intégrée. Température de couleur neutre de 4000K. Forme arrondie tendance. La série comprend des modèles de suspensions de différents diamètres.

BS



1



2



3

1 ■ **MOD415PL-L36BS4K** 2 ■ **MOD415PL-L45BS4K** 3 ■ **MOD415PL-L60BS4K**

LED 36W 2500lm
t° 4000K >80Ra 120°
IP 20



LED 45W 3100lm
t° 4000K >80Ra 120°
IP 20

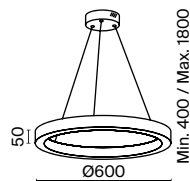

LED 60W 4200lm
t° 4000K >80Ra 120°
IP 20

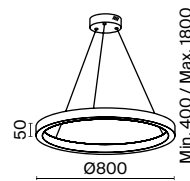



MOD415PL-L36BS4K

MOD415PL-L45BS4K

MOD415PL-L60BS4K

Skyline

BS W

NEW LED IP20

EN Fittings material – metal, shade – black. Two color solutions for decorative elements: black + brass, black + white. The asymmetrical composition creates an effect of a sea sunset for the design. Adjustable height of suspensions. Wall lamps can be used both vertically and horizontally. LED light source, color temperature - 4000K.

DE Material der Beschläge - Metall, Farbton - Schwarz. Zwei Farbtöne für dekorative Elemente: Schwarz + Messing, Schwarz + Weiß. Asymmetrische Komposition schafft einen Effekt des maritimen Sonnenuntergangs im Design. Pendelleuchten mit einstellbarer Höhe. Die Wandleuchte kann sowohl vertikal als auch horizontal verwendet werden. LED-Lichtquelle, Farbtemperatur - 4000K.

IT Il materiale dell'armatura è il metallo, il colore è nero. Gli elementi decorative sono realizzati in due colori: nero + ottone, nero + bianco. La composizione asimmetrica crea un effetto del tramonto marino nel design. L'altezza regolabile delle sospensioni. Le applique possono essere utilizzate sia verticalmente che orizzontalmente. L'illuminazione a LED, la temperatura del colore-4000K.

FR Matériel de l'armature - métal, teinte - noir. Deux combinaisons de teinte pour les éléments décoratifs : noir + laiton, noir + blanc. La composition asymétrique crée l'effet d'un coucher de soleil maritime dans le design. Hauteur de suspension réglable. L'applique murale peut être utilisée à la fois verticalement et horizontalement. Source de lumière LED, température de couleur - 4000K.

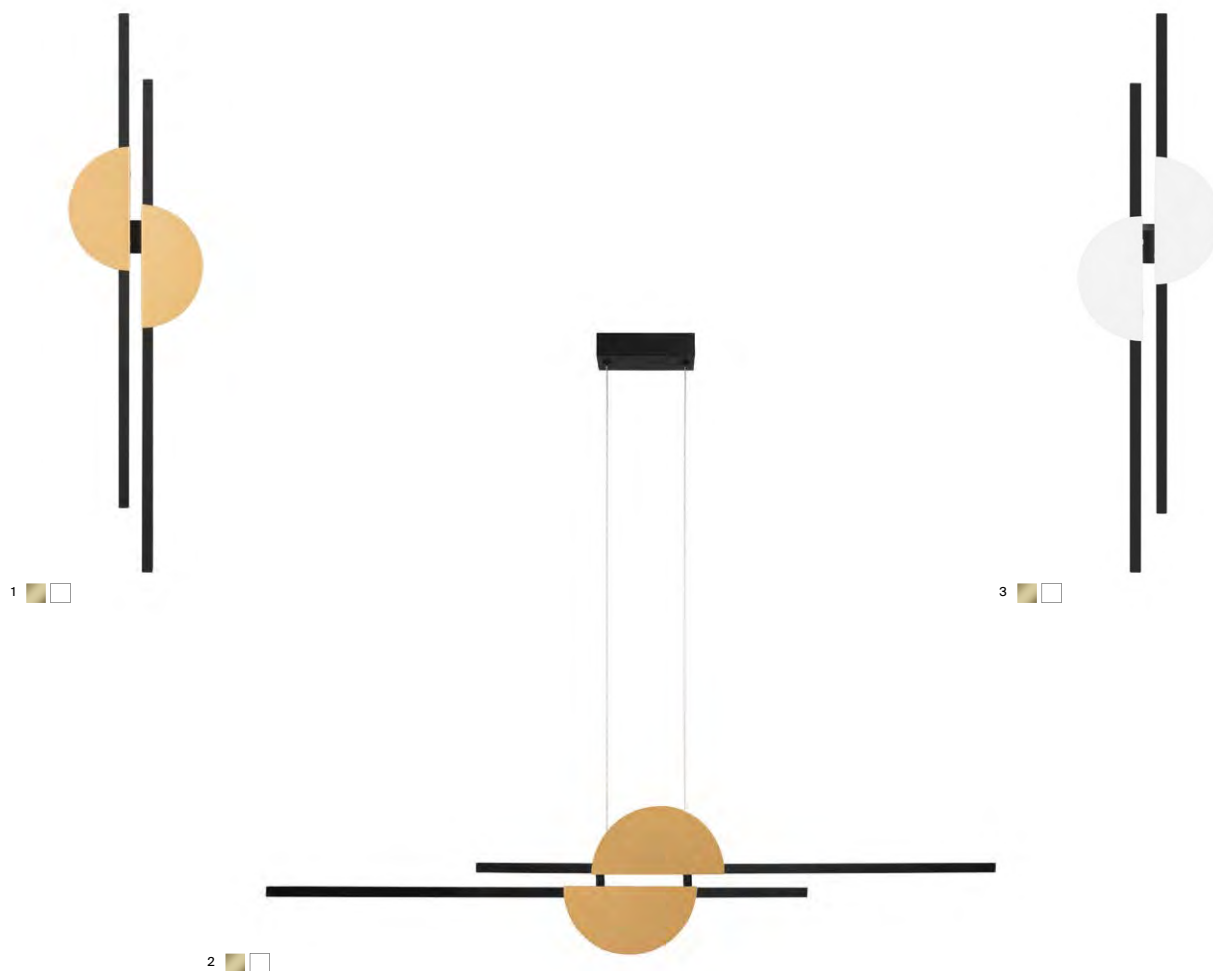

- 1 **MOD179WL-L22BS4K**
 MOD179WL-L22W4K
- 2 **MOD179PL-L26BS4K**
 MOD179PL-L26W4K
- 3 **MOD179WL-L22BS4K1**
 MOD179WL-L22W4K1

LED 23W 700lm
 t° 4000K >80Ra 120°
 IP 20

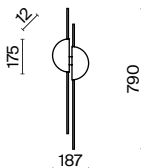

LED 26W 800lm
 t° 4000K >80Ra 120°
 IP 20

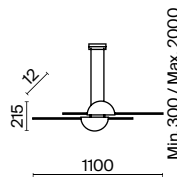

LED 23W 700lm
 t° 4000K >80Ra 120°
 IP 20

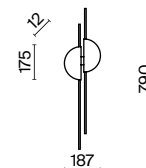



MOD179PL-L26W4K

MOD179WL-L22W4K

MOD179WL-L22W4K1

Stelo

B BS

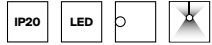

EN Metal fittings in two colors: black and brass. Dome lamp – transparent glass tube. LED light sources with a color temperature of 3000K. Simple geometric shapes.

DE Metallbeschläge in 2 Farbtönen: Schwarz und Messing. Lampenschirm: Transparenter Glasrohr. LED Lichtquellen mit einer Farbtemperatur von 3000K. Einfache geometrische Formen.

IT Armatura metallica in due tonalità: nero e ottone. Plafoniera: tubo di vetro trasparente. Sorgenti luminose a LED con temperatura di colore di 3000K. Forme geometriche semplici.

FR Armature en métal en deux teintes : noir et laiton. Globe : tube de verre transparent. Sources de lumière LED avec une température de couleur de 3000K. Formes géométriques simples.



1 ■ ■

■ **MOD116WL-L7B3K**
 ■ **MOD116WL-L7BS3K**

LED 7W 600lm
 t° 3000K >80Ra 120°
 IP 20

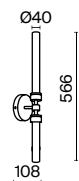



MOD116WL-L7BS3K

Supersymmetry

B W

LED IP20 SMART TUYA

EN Fittings material – metal. Shades – white, black, matte black. Dimmable driver. Transforming lamp, source of general and directional light. Symmetrical parts are separated and connected using magnetic elements. LED light source.

DE Metallbeschläge, Farbtöne: Weiß, Schwarz, mattes Schwarz. Dimmbarer Treiber. Die Kombi-Leuchte, eine Quelle für allgemeines und gerichtetes Licht. Symmetrische Teile werden durch magnetische Elemente getrennt und miteinander verbunden. LED-Lichtquelle.

IT Materiale dell'armatura - metallo. Tonalità: bianco, nero, nero opaco. driver dimmerabile. Lampada-trasformatore, sorgente di luce generale e direzionale. Le parti simmetriche sono separate e collegate mediante elementi magnetici. Sorgente luminosa a LED.

FR Matériau de l'armature : métal. Teintes: blanc, noir, noir mat. Commande de variation. Luminaire transformable, source d'éclairage général et orientable. Les parties symétriques se séparent et s'assemblent à l'aide d'éléments aimantés. Source de lumière LED.



1 ■ □



2 ■ □

1 ■ **P096PL-L11BK**
□ **P096PL-L11WK**

LED 17W 880lm
t° 4000K >80Ra 120°
IP 20

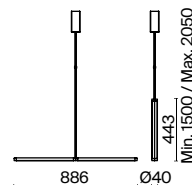

2 ■ **P096PL-L11BK1**
□ **P096PL-L11WK1**

LED 18W 1000lm
t° 4000K >80Ra 120°
IP 20

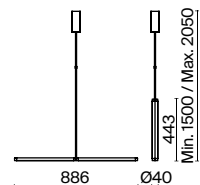



P096PL-L11BK



Tau



EN Aluminum body. Shades – gold, combination of gold and black. Diffuser of two types– silicone tube and extra strong cord (does not turn yellow over time, has high strength). Soft, even light thanks to the high density of the LEDs. Color temperature is 3000K. LED light source.

DE Rahmen aus Aluminium. Farbtöne: Gold, eine Kombination aus Gold und Schwarz. Zwei Arten von Diffusoren: Ein Silikonschlauch und ein superfestes Kabelbündel (vergilbt im Laufe der Zeit nicht, hat eine hohe Festigkeit). Weiches, gleichmäßiges Leuchten dank der hohen Dichte der LEDs. Farbtemperatur 3000K. LED-Lichtquelle.

IT Corpo in alluminio. Sfumature: oro, combinazione di oro e nero. Diffusore di due tipi: tubo in silicone e laccio super resistente super resistente (non ingiallisce nel tempo, ha un'elevata resistenza). Luce morbida e uniforme grazie all'alta densità dei LED. Temperatura di colore 3000K. Sorgente luminosa a LED.

FR Corps en aluminium. Teintes : dorée, combinaison de dorée et noir. Diffuseur de deux types : tube silicone et gaine extra résistante (ne jaunit pas avec le temps, possède une forte solidité). Éclairage doux uniforme grâce à une haute densité des LED. Température de couleur : 3000K. Source de lumière LED.



2 ■ ■



2 ■ ■

1 ■ **MOD146PL-L40B3K**
 ■ **MOD146PL-L40G3K**

LED 40 W 2200lm
 t° 3000K >80Ra 260°
 IP 20

2 ■ ■ **MOD166PL-L30GB3K**
 ■ **MOD166PL-L30G3K**

LED 30 W 1500lm
 t° 3000K >80Ra 260°
 IP 20

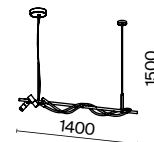
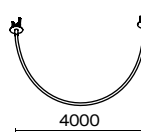



MOD166FL-L15B3K

Tau



3 ■ MOD166PL-L20G3K

LED 21W 910lm
 t° 3000K >80Ra 260°
 IP 20

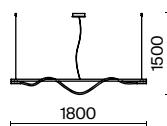

4 ■ MOD166FL-L15B3K

LED 15W 450lm
 t° 3000K >80Ra 260°
 IP 20



5 ■ MOD166WL-L12G3K

LED 13W 600lm
 t° 3000K >80Ra 260°
 IP 20

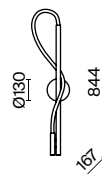

Plons

BS

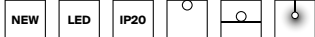

EN Aluminium fittings, color: brass. Silicone diffuser. LED light source, color temperature: 3000K.

DE Material der Beschläge - Aluminium, Farbe - Messing. Silikondiffusor. LED-Lichtquelle, Farbtemperatur - 3000K.

IT Il materiale dell'armatura è alluminio, il colore è l'ottone. Il diffusore è in silicone. La sorgente luminosa a LED, la temperatura di colore è 3000K.

FR Matériau de l'armature - aluminium, couleur - laiton. Diffuseur en silicone. Source de lumière LED, température de couleur 3000K.



1



2

1 ■ **MOD283CL-L34BS3K** 2 ■ **MOD283TL-L12BS3K**

LED 34W 2040lm
t° 3000K >80Ra 180°
IP 20

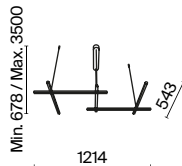

LED 12W 760lm
t° 3000K >80Ra 180°
IP 20

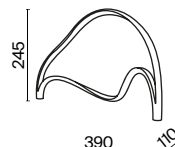

Radiance

G

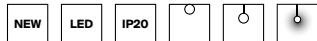

EN Metal fittings coated with a galvanic layer of satin brass. A built-in LED light source. Silicone diffuser. Color temperature: 3000K. Suspended lamps are equipped with a 3-meter adjustable wire for rooms with high ceilings.

DE Metallbeschläge, die mit einer galvanischen Schicht aus satiniertem Messing beschichtet sind. Eingebaute LED-Lichtquelle. Silikondiffusor. Farbtemperatur 3000K. Die Pendelleuchten haben ein verstellbares Kabel von 3m für Räume mit hohen Decken.

IT L'armatura metallica e' coperto da uno strato di un ottone satinato. Il sorgente luminosa a LED integrata. Il diffusore fatto in silicone. La temperatura di colore e' 3000K. Le lampade a sospensione hanno un cavo regolabile della lunghezza di 3 metri per gli ambienti con soffitti alti.

FR Armature métallique recouverte d'une couche galvanique de laiton satiné. Source de lumière LED intégrée. Diffuseur en silicone. Température de couleur 3000K. Les suspensions disposent d'un fil réglable de 3 mètres des pièces avec de hauts plafonds.

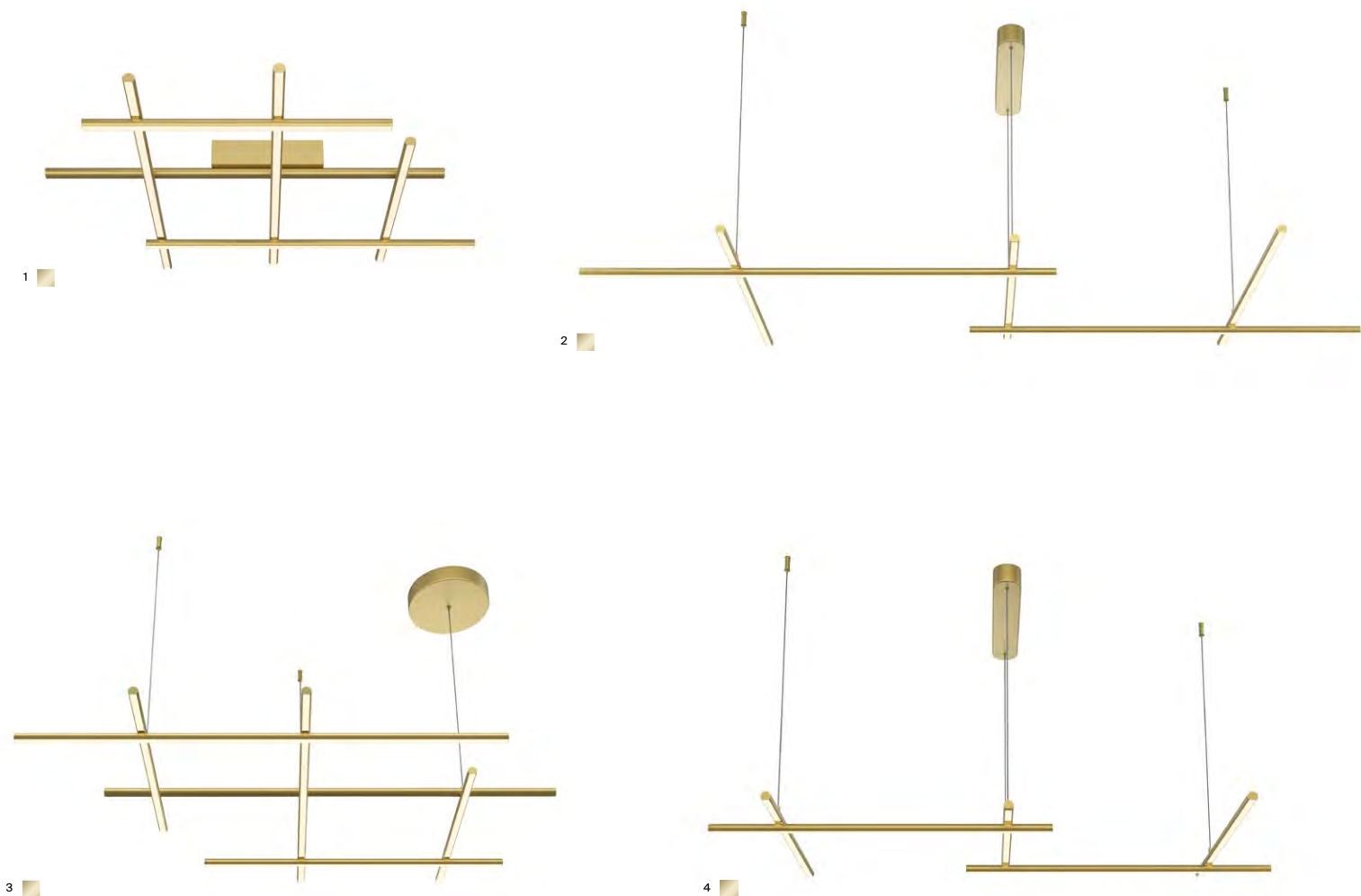

1 **MOD278CL-L50G3K**

LED 50 W 2250lm
 t° 3000K >80Ra 120°
 IP 20

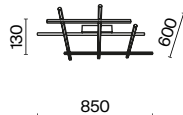

2 **MOD278PL-L86G3K**

LED 80 W 3150lm
 t° 3000K >80Ra 120°
 IP 20

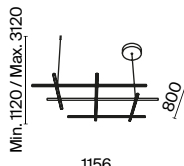

3 **MOD278PL-L86G3K1**

LED 80 W 1900lm
 t° 3000K >80Ra 120°
 IP 20

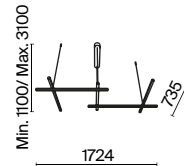

4 **MOD278PL-L50G3K**

LED 50 W 2150lm
 t° 3000K >80Ra 120°
 IP 20

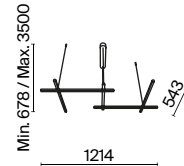



MOD278PL-L86G3K1

Mira

B G

NEW LED IP20

EN A metal luminous element in two colors (brass, black) with a hidden diffuser. A white matte reflector disc softly diffuses the light. LED light source, Color temperature: 3000K.

DE Lichtelement aus Metall in zwei Farben (Messing, Schwarz) mit verstecktem Diffusor. Die weiße und matte Reflektorscheibe streut das Licht sanft. LED-Lichtquelle, Farbtemperatur - 3000K.

IT L' elemento luminoso metallic e' in due colori (ottone, nero) con il diffusore nascosto. Il riflettore a disco bianco opaco diffonde delicatamente la luce. La sorgente luminosa a LED, la temperatura di colore e' 3000K.

FR Élément lumineux en métal bicolore (laiton, noir) avec diffuseur caché. Le disque réflecteur blanc mat diffuse doucement la lumière. Source de lumière LED, température de couleur 3000K.

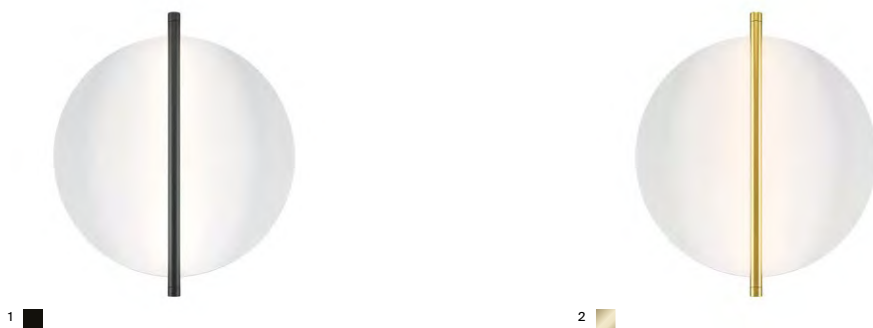

1 ■ **MOD279WL-L14B3K**

2 ■ **MOD279WL-L14G3K**

LED 14 W 200lm
 t° 3000K >80Ra 120°
 IP 20

LED 14 W 300lm
 t° 3000K >80Ra 120°
 IP 20

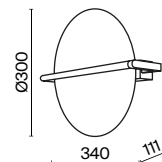
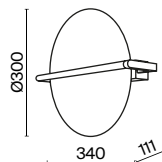



SPECTACULAR MOMENTS OF LIGHT REFLECTION

As an adept artisan, I craft luminous strokes and reflections, fashioning enthralling scenes of light and shadow that infuse space with warmth and an enigmatic allure. I stand as a wellspring of inspiration, a transformative force that imbues your surroundings with charm and mystique.

The Light Reflection collection draws its essence from the peerless theater of shadows, where narratives unfurl through the interplay of radiant beams and obsidian glimmers.



Pro	P. 350
Line	P. 358
Rim	P. 360

Pro Base

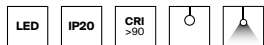

EN Fittings material – metal. Fittings' shades – black, white, gold. Minimalistic forms, concise thin shapes. Convenient for assembling compositions. Models with acrylic diffuser have LED light source, color temperature 4000K..

DE Material der Beschläge - Metall. Farbtöne der Beschläge - Schwarz, Weiß, Gold. Minimalistische, lakonische und schlanke Formen. Bequem für die Zusammenstellung von Kompositionen. Bei Modellen mit Acryl-Diffusor - LED-Lichtquelle, Farbtemperatur - 4000K.

IT Il materiale dell'armatura è il metallo, i colori sono nero, bianco, oro. Le forme sono minimaliste, sottili e laconici. Esse sono comode per la creazione delle composizioni. I modelli con diffusore acrilico dotati dell'illuminazione a LED, la temperatura del colore-4000K.

FR Matériel de l'armature - métal. Teinte de l'armature - noir, blanc, or. Formes minimalistes, formes minces laconiques. Pratiques pour faire des compositions. Les modèles avec diffuseur en acrylique ont une source de lumière LED, température de couleur 4000K.



1

- 1 **MOD159PL-L6G4K2**
- MOD159PL-L6B4K2**
- MOD159PL-L6W4K2**

LED 6W 500lm
t° 4000K >90Ra 24°
IP 20

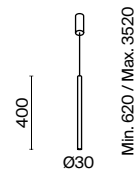



MOD159PL-L6W4K2

Pro Extra

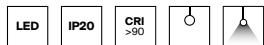

EN Fittings material – metal. Fittings' shades – black, white, gold. Minimalistic forms, concise thin shapes. Convenient for assembling compositions. Models with acrylic diffuser have LED light source, color temperature 4000K.

DE Material der Beschläge - Metall. Farbtöne der Beschläge - Schwarz, Weiß, Gold. Minimalistische, lakonische und schlanke Formen. Bequem für die Zusammenstellung von Kompositionen. Bei Modellen mit Acryl-Diffusor - LED-Lichtquelle, Farbtemperatur - 4000K.

IT Il materiale dell'armatura è il metallo, i colori sono nero, bianco, oro. Le forme sono minimaliste, sottili e laconici. Esse sono comode per la creazione delle composizioni. I modelli con diffusore acrilico dotati dell'illuminazione a LED, la temperatura del colore-4000K.

FR Matériel de l'armature - métal. Teinte de l'armature - noir, blanc, or. Formes minimalistes, formes minces laconiques. Pratiques pour faire des compositions. Les modèles avec diffuseur en acrylique ont une source de lumière LED, température de couleur 4000K.



1

- MOD160PL-L6G4K1**
- MOD160PL-L6B4K1**
- MOD160PL-L6W4K1**

LED 6W 500lm
t° 4000K >90Ra 24°
IP 20

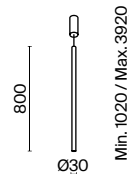

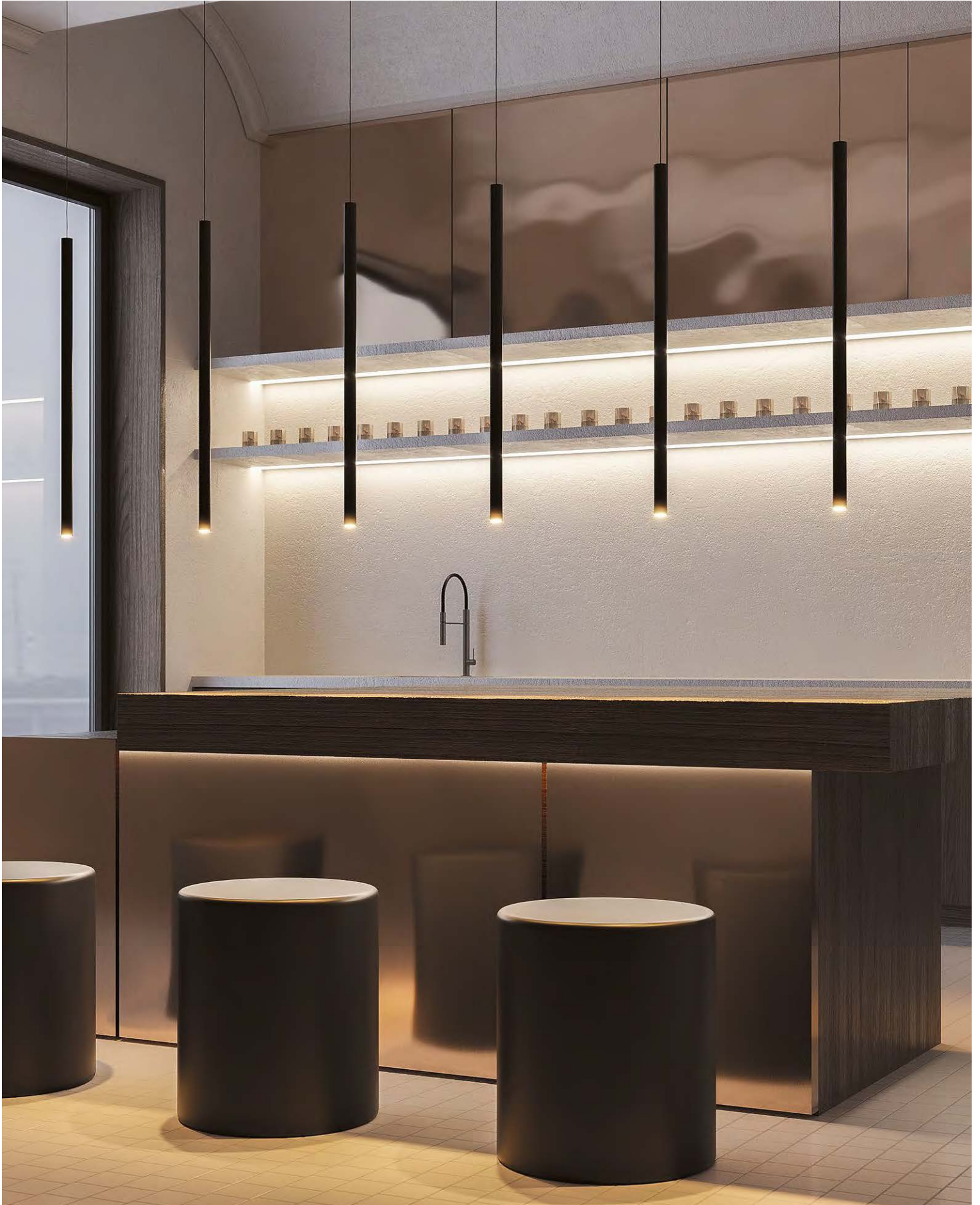

MOD160PL-L6B4K1

Pro Shade

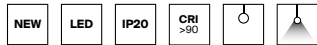

EN Fittings material – metal. Fittings' shades – black, white, gold. Minimalistic forms, concise thin shapes. Convenient for assembling compositions. Models with acrylic diffuser have LED light source, color temperature 4000K.

DE Material der Beschläge - Metall. Farbtöne der Beschläge - Schwarz, Weiß, Gold. Minimalistische, lakonische und schlanke Formen. Bequem für die Zusammenstellung von Kompositionen. Bei Modellen mit Acryl-Diffusor - LED-Lichtquelle, Farbtemperatur - 4000K.

IT Il materiale dell'armatura è il metallo, i colori sono nero, bianco, oro. Le forme sono minimaliste, sottili e laconici. Esse sono comode per la creazione delle composizioni. I modelli con diffusore acrilico dotati dell'illuminazione a LED, la temperatura del colore-4000K.

FR Matériel de l'armature - métal. Teinte de l'armature - noir, blanc, or. Formes minimalistes, formes minces laconiques. Pratiques pour faire des compositions. Les modèles avec diffuseur en acrylique ont une source de lumière LED, température de couleur 4000K.



- 1 **MOD157PL-L6G4K1**
- MOD157PL-L6B4K1**
- MOD157PL-L6W4K1**

LED 6W 500lm
t° 4000K >90Ra 75°
IP 20

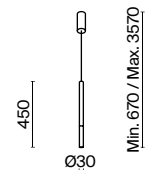



MOD157PL-L6G4K1

MOD157PL-L6B4K1

MOD157PL-L6W4K1

Pro Focus

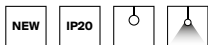

EN Fittings material – metal. Fittings' shades – black, white, gold, silver, brass. Minimalistic forms, concise thin shapes. Convenient for assembling compositions. Light source - lamp with a GU10 base. Lamps are not included.

DE Material der Beschläge - Metall. Farbtöne der Beschläge - Schwarz, Weiß, Gold, Silber, Messing. Minimalistische, lakonische und schlanke Formen. Bequem für die Zusammenstellung von Kompositionen. . Lichtquelle - Leuchtmittel mit GU10-Fassung. Lampen nicht im Lieferumfang enthalten.

IT Il materiale dell'armatura è il metallo, i colori sono nero, bianco, oro, argento, ottone. Le forme sono minimaliste, sottili e laconici. Esse sono comode per la creazione delle composizioni. La sorgente dell'illuminazione sono le lampadine con portalampe GU10. Le lampadine non sono disponibili su questo modello.

FR Matériel de l'armature - métal. Teinte de l'armature - noir, blanc, or, argent, laiton. Formes minimalistes, formes minces laconiques. Pratiques pour faire des compositions. Source de lumière - lampe avec culot GU10. Les lampes ne sont pas incluses.



- 1 **MOD161PL-01G1**
- MOD161PL-01W1**
- MOD161PL-01BS1**
- MOD161PL-01CM1**
- MOD161PL-01B1**

1 × GU10 6 W
IP 20

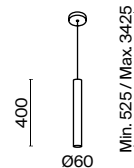



Line

W B MG

NEW IP20 LED

EN Fittings material— metal and acrylic, shades – white, black, matte gold. Integrated LED sources, acrylic diffuser. Color temperature is from 3000K to 4000K. Trendy asymmetry in design. Adjustable height.

DE Material der Beschläge: Metall und Acryl, Farbtöne: Weiß, Schwarz, mattes Gold. Integrierte LED-Quellen, Acryl-Diffusor. Farbtemperatur von 3000K bis 4000K. Trendige Asymmetrie im Design. Einstellbare Höhe.

IT Materiale dell'armatura - metallo e acrilico , tonalità - bianco, nero, oro opaco. Sorgenti LED integrate, diffusore in acrilico. Temperatura di colore da 3000K a 4000K. Asimmetria alla moda nel design. Altezza regolabile.

FR Matériau de l'armature : métal et acrylique, teintes : blanc, noir, dorée mat. Sources LED intégrées, diffuseur acrylique. Température de couleur : de 3000K à 4000K. Design asymétrique tendance. Hauteur réglable.



1,2 ■

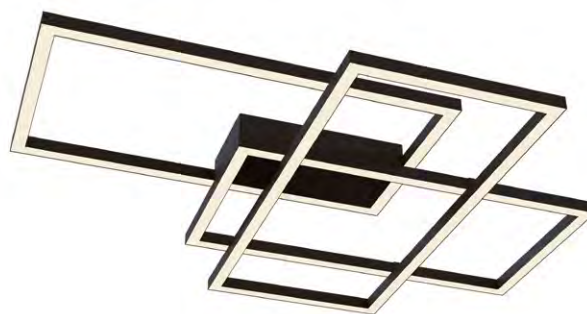

3,4 ■



5,6 ■



7 ■ □

■ **MOD016PL-L75MG3K**

LED 79W 3100lm
t° 3000K >80Ra 120°
IP 20

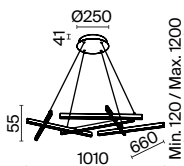

■ **MOD016PL-L75MG4K**

LED 75W 3500lm
t° 4000K >80Ra 120°
IP 20

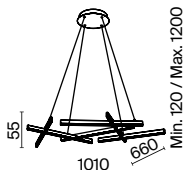

■ **MOD015CL-L80B**

LED 80W 4100lm
t° 3000K >80Ra 360°
IP 20

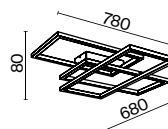

■ **MOD016CL-L80BK**

LED 78W 2900lm
t° 3000-4000K >80Ra 120°
IP 20

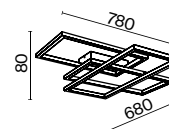



MOD016PL-L75B

- 5 ■ **MOD054PL-L52B4K** 6 ■ **MOD054PL-L52B3K** 7 ■ **MOD016PL-L75B**
 □ **MOD016PL-L75W**

LED 52W 2200lm
 t° 4000K >80Ra 60°
 IP 20

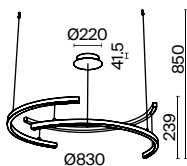

LED 52W 2000lm
 t° 3000K >80Ra 60°
 IP 20

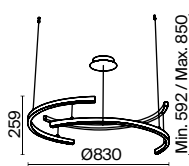

LED 79W 3100lm
 t° 3000K >80Ra 120°
 IP 20

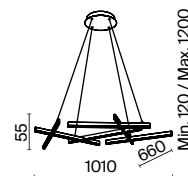

Rim

BS B

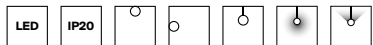

EN Fittings material— aluminum, shades — black, brass. Relevant circle shape. Integrated LED light sources. The position of the rings of pendant models is adjustable. Wall lamp with light source beamed to the wall — trendy reflective backlight.

DE Material der Beschläge: Aluminium, Farbtöne: Schwarz, Messing. Aktuelle Kreisform. Integrierte LED-Lichtquellen. Einstellbare Position der Ringe der Pendelmodelle. Wandleuchten mit einer Lichtquelle, die auf die Wand gerichtet ist: eine trendige reflektierte Beleuchtung.

IT Materiale dell'armatura - alluminio, tonalità - nero, ottone. Forma moderna del cerchio. Sorgenti luminose a LED integrate. La posizione degli anelli dei modelli pensili è regolabile. Applique con sorgente luminosa diretta alla parete - illuminazione indiretta alla moda.

FR Matériau de l'armature : aluminium, teintes : noir, laiton. Forme arrondie en vogue. Sources de lumière LED intégrées. Position des anneaux des modèles de suspension réglable. Applique avec source de lumière orientée vers le mur : luminaire réfléchissant tendance.

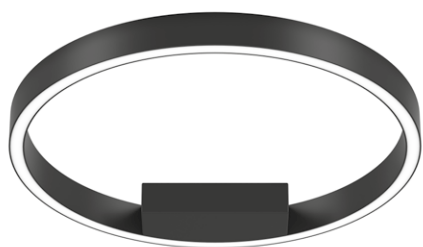

1,2 ■ ■



3,4 ■ ■



5 ■ ■



6 ■ ■



7 ■ ■

1 ■ **MOD058CL-L25B3K**
■ **MOD058CL-L25BS3K**

LED 25W 1200lm
t° 3000K >80Ra 120°
IP 20

2 ■ **MOD058CL-L25B4K**
■ **MOD058CL-L25BS4K**

LED 25W 1200lm
t° 4000K >80Ra 120°
IP 20

3 ■ **MOD058CL-L35B4K**
■ **MOD058CL-L35BS4K**

LED 37W 1800lm
t° 4000K >80Ra 120°
IP 20

4 ■ **MOD058CL-L35B3K**
■ **MOD058CL-L35BS3K**

LED 37W 1800lm
t° 3000K >80Ra 120°
IP 20

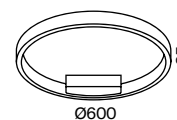
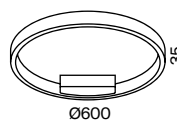
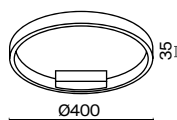
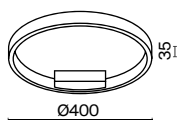



MOD058CL-L35BS4K

⁵ ■ MOD058WL-L25B3K
■ MOD058WL-L25BS3K

LED 25W 1200lm
t° 3000K >80Ra 120°
IP 20

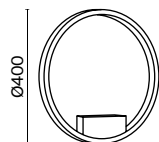

⁶ ■ MOD058WL-L35B3K
■ MOD058WL-L35BS3K

LED 37W 1800lm
t° 3000K >80Ra 120°
IP 20

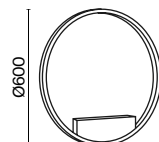

⁷ ■ MOD058WL-L50B3K
■ MOD058WL-L50BS3K

LED 51W 2400lm
t° 3000K >80Ra 120°
IP 20

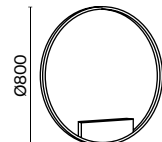

Rim

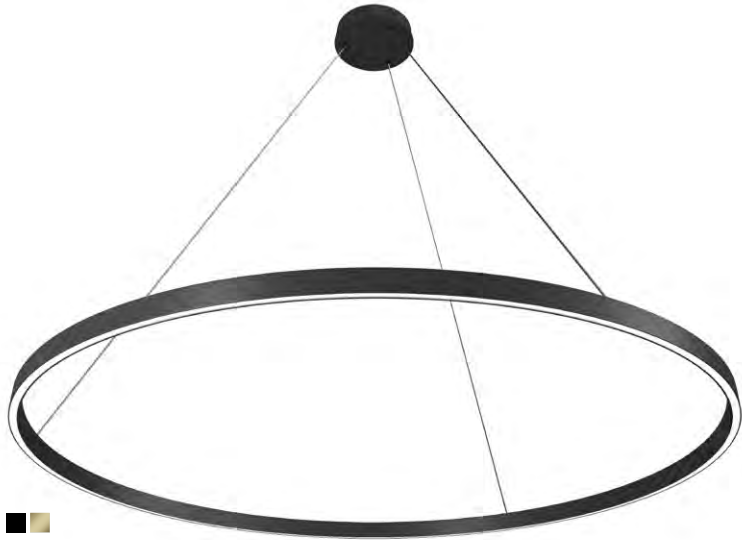

8,9 ■ ■



10,11 ■ ■

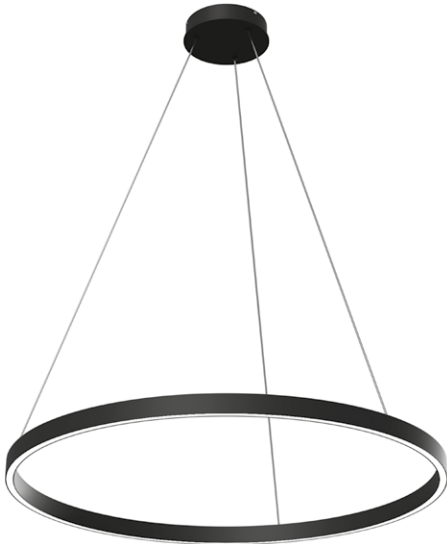

12 ■ ■



13 ■ ■

8 ■ **MOD058PL-L65B3K**
 ■ **MOD058PL-L65BS3K**

LED 81W 2800lm
 t° 3000K >80Ra 120°
 IP 20



9 ■ **MOD058PL-L54B3K**
 ■ **MOD058PL-L54BS3K**

LED 61W 3500lm
 t° 3000K >80Ra 120°
 IP 20

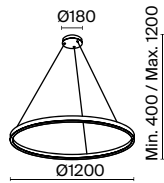

10 ■ **MOD058PL-L42B3K**
 ■ **MOD058PL-L42BS3K**

LED 51W 3000lm
 t° 3000K >80Ra 120°
 IP 20

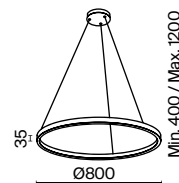

11 ■ **MOD058PL-L42B4K**
 ■ **MOD058PL-L42BS4K**

LED 51W 3000lm
 t° 4000K >80Ra 120°
 IP 20

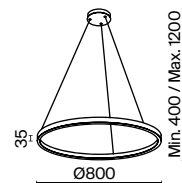



MOD058PL-L100BS3K

¹² ■ **MOD058PL-L32B4K**
 ■ **MOD058PL-L32BS4K**

LED 37W 2200lm
 t° 4000K >80Ra 120°
 IP 20

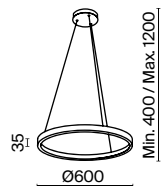

¹³ ■ **MOD058PL-L32B3K**
 ■ **MOD058PL-L32BS3K**

LED 37W 2200lm
 t° 3000K >80Ra 120°
 IP 20

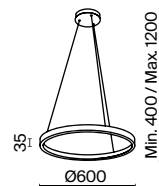

Rim



14, 15 ■ ■

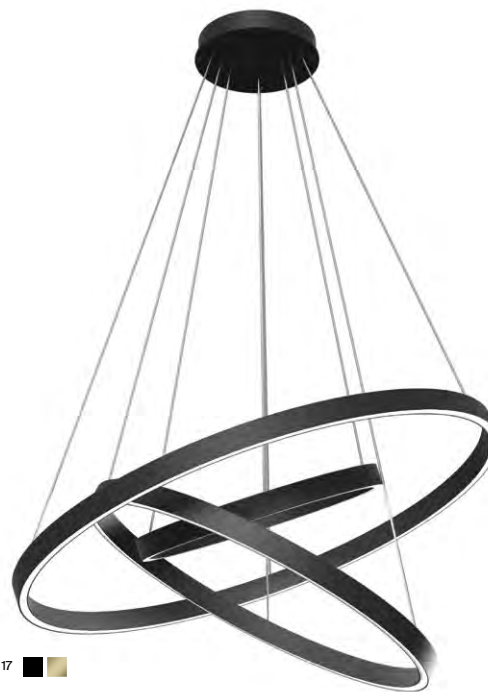

16, 17 ■ ■



18 ■ ■



19 ■ ■

14 ■ **MOD058PL-L74B3K**
■ **MOD058PL-L74BS3K**

LED 88 W 5200lm
t° 3000K >80Ra 120°
IP 20

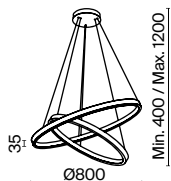

15 ■ **MOD058PL-L74B4K**
■ **MOD058PL-L74BS4K**

LED 88 W 5200lm
t° 4000K >80Ra 120°
IP 20

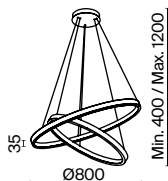

16 ■ **MOD058PL-L100B4K**
■ **MOD058PL-L100BS4K**

LED 115 W 6100lm
t° 4000K >80Ra 120°
IP 20

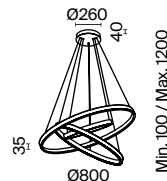

17 ■ **MOD058PL-L100B3K**
■ **MOD058PL-L100BS3K**

LED 115 W 6100lm
t° 3000K >80Ra 120°
IP 20

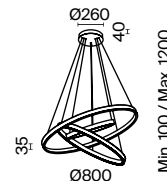



MOD058PL-L074BS3K

18 ■ **MOD058PL-L22B3K**
■ **MOD058PL-L22BS3K**

LED 25W 1200lm
t° 3000K >80Ra 120°
IP 20

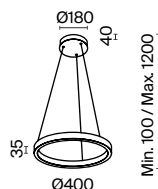

19 ■ **MOD058PL-L55B3K**
■ **MOD058PL-L55BS3K**

LED 61W 3500lm
t° 3000K >80Ra 120°
IP 20

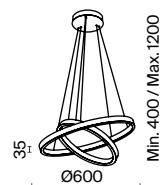

Accessories Rim

BS B



1 ■ ■

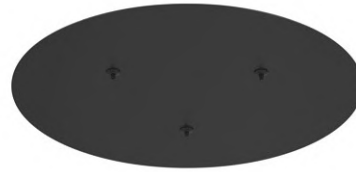

2 ■ ■



1 ■ MOD058A-02BS
■ MOD058A-02B

2 ■ MOD058A-03BS
■ MOD058A-03B

Satellite

W B



EN Fittings are made of metal in two colors: white and black. Spots with LED modules do not move around the ring and are adjustable in two planes: horizontally (340°), vertically (90°).

DE Beschläge aus Metall in zwei Farbtönen: Weiß und Schwarz. Strahler mit LED-Modulen bewegen sich nicht um den Ring und sind in zwei Ebenen verstellbar: horizontal (340°) und vertikal (90°).

IT L'armatura è realizzata in metallo di due tonalità: bianco e nero. I faretti con moduli LED non si muovono attorno all'anello e sono orientabili su due piani: orizzontalmente (340°), verticalmente (90°).

FR Armature réalisée en métal en deux teintes : blanc et noir. Spots avec modules LED non déplaçables sur l'anneau et réglables dans les deux plans : à l'horizontale (340°) et à la verticale (90°).



1 ■ □

1 ■ **MOD102PL-L42B**
□ **MOD102PL-L42W**

LED 42 W 3900lm
t° 3000K >80 Ra 24°
IP 20

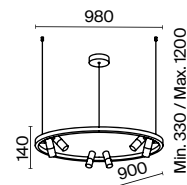

Universal base

W B



1



2



3

1 SPR-BASE-R-03-B
 SPR-BASE-R-03-W

2 SPR-BASE-R-02-B
 SPR-BASE-R-02-W

3 SPR-BASE-03-B
 SPR-BASE-03-W

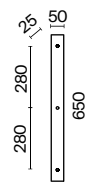
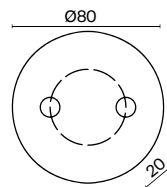
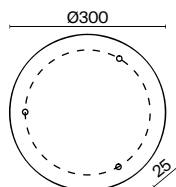



Bergamo

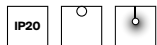

EN Metal fittings. Two color scores: white and chrome. Lampshade of textile and linen, applied to PVC. Colors – beige, grey, white. Lamp with E27 base.

DE Metallbeschläge. Zwei Farbtöne: Weiß und Chrom. Lampenschirm aus Textil und Leinen, auf PVC aufgetragen. Farbtöne: Beige, Grau, Weiß. Leuchtmittel mit E27-Fassung.

IT Armatura metallica. Due combinazioni di colori: bianco e cromato. Paralume in tessuto e lino applicato al PVC. Colori: beige, grigio, bianco. Lampadina con attacco E27.

FR Armature métallique. Deux choix de couleurs : blanc et chrome. Abat-jour en textile et lin appliqué sur PVC. Couleurs : beige, gris, blanc. Ampoule à culot E27.



1



2



3



4

1 **MOD613CL-03W**

💡 3 × E27 60 W
IP 20

2 **MOD613CL-03W1**

💡 3 × E27 60 W
IP 20

3 **MOD613CL-04GR**

💡 3 × E27 60 W
IP 20

4 **MOD617CL-04GR**

💡 3 × E27 60 W
IP 20

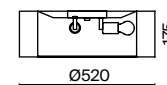
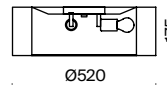
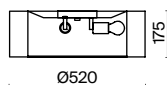
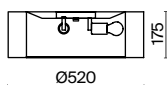



Calvin

EN Floor lamp on a tripod. Base material— wood and metal. Decorative wing screws. Cotton lampshade, applied to PVC. Color – brown, white and black.

DE Stehleuchte auf einem Stativ. Sockelmaterial: Holz und Metall. Dekorative Flügelschrauben. Lampenschirm aus Baumwolle, auf PVC aufgetragen. Farbtöne: Braun, Weiß und Schwarz.

IT Lampada da terra su treppiede. Il materiale di piede è legno e metallo. Viti ad alette decorative. Paralume in cotone applicato al PVC. Colore: marrone, bianco e nero.

FR Lampadaire sur trépied. Matériau de la base : bois et métal. Vis à oreilles décoratives. Abat-jour en coton appliqué sur PVC. Couleur : marron, blanc et noir.

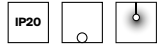
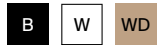

- 1 ■ **Z177FL-01B**
- **Z177FL-01W**
- **Z177FL-01BR**

1 × E27 60 W
IP 20

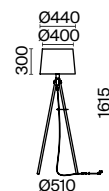



Campanula

B

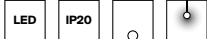

EN Fittings - metal telescopic tube in black color. Textile lampshade in black color. The base is made of concrete to maintain the balance of the structure. E27 base.

DE Beschläge: Teleskoprohr aus Metall in Schwarz. Lampenschirm aus Textil in Schwarz. Der Sockel besteht aus Beton zum Gleichgewichthalten der Konstruktion. Fassung E27.

IT Armatura: un tubo telescopico in metallo di colore nero. Paralume in tessuto di colore nero. Il piede è in cemento per mantenere l'equilibrio della struttura. Attacco E27.

FR Armature : tube métallique télescopique de couleur noire. Abat-jour en textile de couleur noire. Base en béton pour assurer l'équilibre de l'ouvrage. Culot E27.

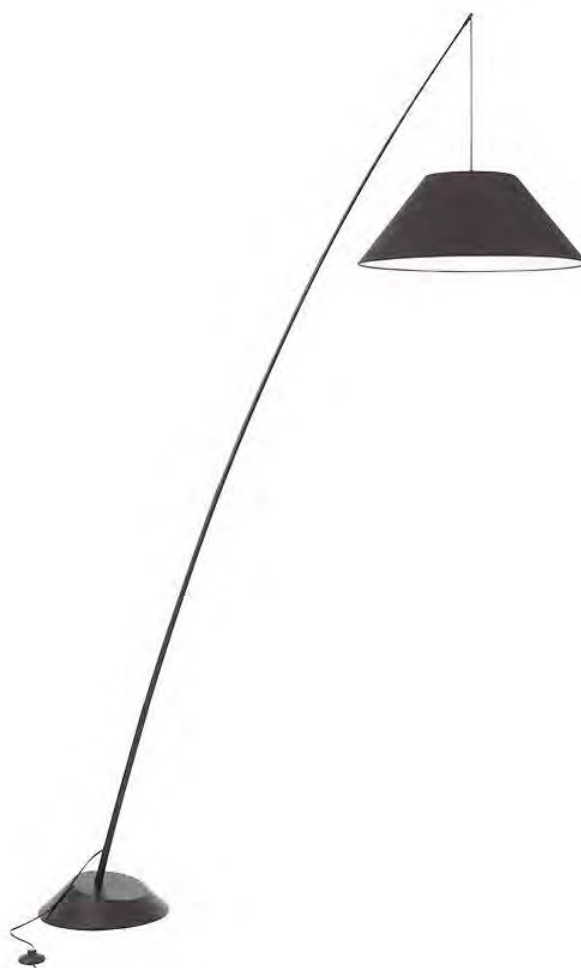

1 ■

1 ■ **Z002FL-01B**

💡 1 × E27 60 W
IP 20

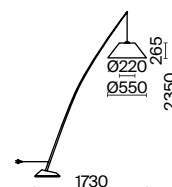



Impressive

G

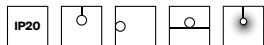

EN Fittings of stainless steel. Color – gold. Lampshade – white fabric. Decorative chains have the same color as the fittings. Removable fabric diffuser softens light flux. Light source – lamps with E14 base.

DE Beschläge aus Edelstahl. Farbton: Gold. Lampenschirm: weißer Stoff. Dekorative Ketten im Farbton der Beschläge. Der abnehmbare Stoffdiffusor mildert den Lichtstrom. Lichtquelle: Leuchtmittel mit E14-Fassung.

IT Armatura in acciaio inossidabile. Colore – oro. Paralume – tessuto bianco. Catene decorative in tinta con l'armatura. Il diffusore in tessuto rimovibile ammorbidisce il flusso luminoso. Sorgente luminosa - lampadine con attacco E14.

FR Armature en acier inoxydable. Couleur : dorée. Abat-jour en tissu blanc. Chaînettes décoratives dans la teinte de l'armature. Le diffuseur amovible en tissu tamise le flux lumineux. Source de lumière : ampoules à culot E14.



1



2



3

1 **MOD151PL-05G**

5 x E14 40 W
IP 20

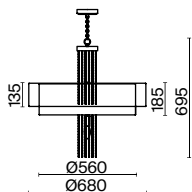

2 **MOD151WL-01G**

1 x E14 40 W
IP 20

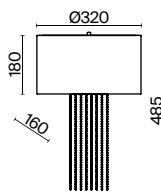

3 **MOD151TL-01G**

1 x E27 40 W
IP 20

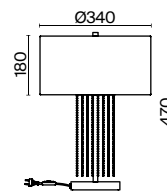



MOD151PL-05G

MOD151TL-01G

Reflex

W

NEW LED IP20

EN Fittings and dome lamp of metal and acrylic. Color – white. Decorative reflective element made of translucent textured fabric. Adjustable height. LED light sources with a color temperature of 3000K.

DE Beschläge und Lampenschirm aus Metall und Acryl. Farbton: Weiß. Dekoratives lichtreflektierendes Element aus durchscheinendem, strukturiertem Stoff. Einstellbare Höhe. LED-Lichtquellen mit einer Farbtemperatur von 3000K.

IT Armatura e plafoniera in metallo e acrilico. Colore – bianco. Elemento decorativo riflettente in tessuto testurizzato traslucido. Altezza regolabile. Sorgenti luminose a LED con temperatura di colore di 3000K.

FR Armature et globe en métal et acrylique. Couleur : blanc. Élément décoratif réfléchissant en tissu texturé translucide. Hauteur réglable. Sources de lumière LED avec une température de couleur de 3000K.



1



2

1 **MOD154PL-L6W3K1**

LED 39 W 2300lm
 t° 3000K >80Ra 300°
 IP 20

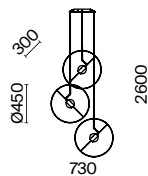

2 **MOD154PL-L6W3K**

LED 14 W 950lm
 t° 3000K >80Ra 300°
 IP 20

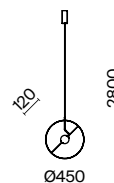



MOD154PL-L6W3K1



Talento

CH



EN Metal fittings, color – chrome. Textile lampshades, applied to PVC. Color – white. Decorative elements – bulk crystal of complex cut. Height of the pendant chandelier is adjustable.

DE Metallbeschläge in Chrom. Lampenschirme aus Textil, auf PVC aufgetragen. Farbton: Weiß. Dekor: massive Kristalle mit komplexem Schliff. Einstellbare Höhe der Pendel-Kronleuchte.

IT Armatura in metallo, colore - cromo. Paralumi in tessuto applicato al PVC. Colore bianco. Decoro: grandi cristalli di taglio complesso. L'altezza del lampadario sospeso è regolabile.

FR Armature en métal, couleur : chrome. Abat-jours en textile appliqué sur PVC. Couleur : blanc. Élément décoratif : cristaux massifs à taille complexe. Hauteur du lustre suspendu réglable.



1



2



3

1 **DIA008PL-05CH**

5 x E14 40W
IP 20

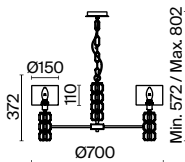

2 **DIA008WL-01CH**

1 x E14 40W
IP 20

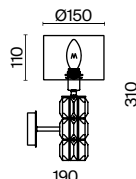

3 **DIA008TL-01CH**

1 x E27 40W
IP 20

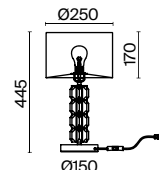



DIA800TL-01CH

DIA800PL-05CH

Bianco

BS

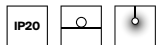

EN Metal fittings, color – brass. Lampshade – white cotton. Design highlight – natural stone elements (alabaster). Trendy mix of textures. Laconic forms in American style.

DE Metallbeschläge, Farbton: Messing. Lampenschirm: Weiße Baumwolle. Highlight des Designs: Elemente aus Naturstein (Alabaster). Trendige Mischung von Texturen. Lakonische Formen im amerikanischen Stil.

IT Armatura in metallo, colore - ottone. La plafoniera è in cotone bianco. Il valore aggiunto del design sono gli elementi in pietra naturale (alabastro). Mix di trame alla moda. Forme laconiche in stile americano.

FR Armature métallique, couleur laiton. Abat-jour en coton blanc. Point fort du design : éléments en pierre naturelle (albâtre). Mélange tendance des textures. Formes laconiques dans le style américain.



1



2

1 ■ **Z030TL-01BS**

💡 1 × E27 60 W
IP 20

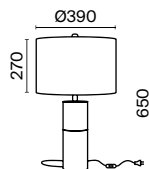

2 ■ **Z031TL-01BS**

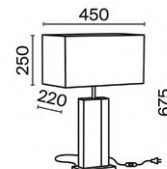

💡 1 × E27 60 W
IP 20





Bicones

W GR
WD WD

IP20  

EN Fittings and dome lamp of metal in two colors: white, grey. Beech decorative element. The wood is covered with transparent lacquer. Contemporary Scandinavian aesthetics. Adjustable height.

DE Beschläge und Lampenschirm aus Metall in zwei Farbtönen: Weiß, Grau. Dekoratives Element aus Buche. Das Holz ist mit farblosem Lack beschichtet. Aktuelle skandinavische Ästhetik. Einstellbare Höhe.

IT Armatura e plafoniera in metallo in due tonalità: bianco, grigio. Elemento decorativo in faggio. Il legno è rivestito di lacca incolore. Estetica scandinava contemporanea.



FR Armature et globe en métal en deux teintes : blanc, gris. Élément décoratif en hêtre. Bois recouvert d'un vernis incolore. Esthétique scandinave en vogue. Hauteur réglable.





1  



2  

1  **P359-PL-140-W**
 **P359-PL-140-C**

⚡ 1 x E27 60 W
IP 20

2  **P359-PL-01-W**
 **P359-PL-220-C**

⚡ 1 x E27 60 W
IP 20

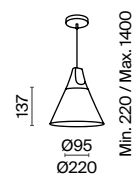
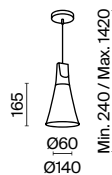



Broni

B
GR

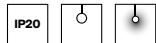

EN Black metal fittings. Grey concrete dome lamp. Optional ceiling mount. Height is adjustable by cord.

DE Metallbeschläge in Schwarz. Lampenschirm aus Beton in Grau. Zusätzliche Deckenbefestigung. Durch ein Seil einstellbare Höhe.

IT Armatura in metallo nero. Plafoniera in cemento grigio. Supporto aggiuntivo a soffitto. L'altezza è regolabile con un cordino.

FR Armature métallique de couleur noire. Globe béton de teinte grise. Fixation de plafond supplémentaire. Hauteur réglable par un cordon.



1 ■



2 ■

1 ■ **T434-PL-01-GR**

💡 1 x E27 60 W
IP 20

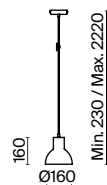

2 ■ **T451-PL-01-GR**

💡 1 x E27 60 W
IP 20

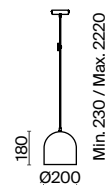



Cane

BG B

NEW IP20

EN Fittings material - metal, color - black. An outer spherical wire-woven lampshade in beige and black colors. The inner dome lamp is a white matte glass sphere. A novel mix of Neo-Classicism and eco-trend: handiwork + natural materials. Adjustable wire length: 3 meters. Light source - lamp with a G9 base.

DE Material der Beschläge - Metall, Farbe - Schwarz. Außenseite - kugelförmiger Lampenschirm aus Drahtgeflecht in Beige und Schwarz. Innenseite - weiße Milchglaskugel. Eine ungewöhnliche Mischung aus Neoklassik und Öko-Trend - handgefertigt + natürliche Materialien. Die einstellbare Kabellänge - 3 Meter. Lichtquelle - Leuchtmittel mit G9-Fassung.

IT Il materiale dell'armatura è metallo, il colore è nero. Il paralume sferico esterno è in tessitura a filo metallico nei colori beige e nero. Il paralume interno è una sfera di vetro bianco opaco. Un insolito mix di neoclassici ed eco-trend è fatto a mano + i materiali naturali. La lunghezza del cavo regolabile è di 3 metri. La sorgente luminosa è una lampadina con un portalampada G9.

FR Le matériau de l'armature est le métal, la couleur est noire. Abat-jour extérieur sphérique tissé en fil beige et noir. L'abat-jour intérieur est une boule blanche mate en verre. Un mélange inhabituel de néo-classicisme et d'éco-tendance - travail à la main + matériaux naturels. Longueur de fil réglable - 3 mètres. Source lumineuse - lampe avec culot G9.



1 **MOD204PL-01BG1**
MOD204PL-01B1

1 x G9 28 W
IP 20

2 **MOD204PL-01BG**
MOD204PL-01B

1 x G9 28 W
IP 20

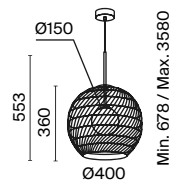
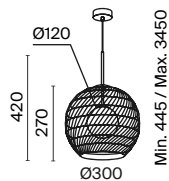



Marmo

G



EN Metal fittings are plated in gold color. Decorative elements— natural stone plates with textured pattern. The combination of rectangular lines and rounded elements in the design. Light source – lamp with E14 base.

DE Metallbeschläge, galvanisiert im Farbton Gold. Dekor: Natursteinplatten mit einem strukturierten Muster. Kombination aus rechteckigen Linien und abgerundeten Elementen im Design. Lichtquelle: Leuchtmittel mit E14-Fassung.

IT Armatura in metallo galvanizzata in colore oro. Decoro: lastre di pietra naturale con disegno strutturato. Combinazione di linee rettangolari ed elementi arrotondati nel design. La sorgente luminosa è una lampadina con attacco E14.

FR Armature métallique galvanisée de couleur dorée. Élément décoratif : plaques de pierre naturelle avec dessin texturé. Combinaison des lignes rectangulaires et des éléments ronds dans le design. Source de lumière : ampoule à culot E14.



1 **MOD099PL-03G**

3 x E14 40 W
IP 20

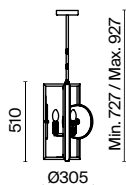

2 **MOD099PL-06G**

6 x E14 40 W
IP 20

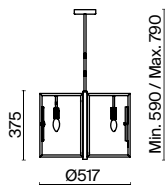

3 **MOD099WL-01G2**

1 x E14 40 W
IP 20

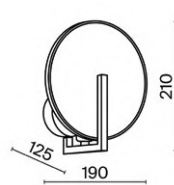

4 **MOD099WL-01G**

1 x E14 40 W
IP 20

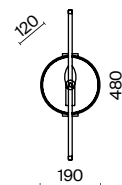





5



6



7

5 ■ **MOD099FL-02G**

💡 2 x G9 40 W
IP 20

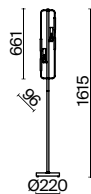

6 ■ **MOD099WL-01G3**

💡 1 x E14 40 W
IP 20

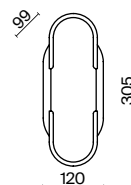

7 ■ **MOD099TL-01G**

💡 1 x E27 40 W
IP 20

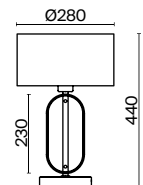

Solid

GR

NEW

LED

IP20



EN Concrete base, color: grey. LED light source, color temperature: 3000K. Diffuser: acrylic tube with a built-in LED light source. Trendy and distinguished design. A stable structure with a compact base to be closely placed to the wall. Controlled with a switch button on the wire.

DE Sockel aus Beton, Farbe - grau. LED-Lichtquelle, Farbtemperatur 3000K. Diffusor: Acrylrohr mit integrierter LED-Lichtquelle. Trendiges und ungewöhnliches Design. Stabile Ausführung mit kompaktem Sockel für die Aufstellung nah an die Wand. Die Steuerung erfolgt über einen Schaltknopf am Kabel.

IT La base è in cemento, il colore è grigio. La sorgente luminosa a LED, la temperatura di colore è 3000K. Il diffusore è il tubo acrilico con la sorgente luminosa a LED integrata. Il design di tendenza è insolito. La struttura stabile con una base compatta per il posizionamento vicino alla parete. Il controllo avviene tramite il pulsante dell'interruttore situato sul cavo.

FR La base est en béton, couleur - gris. Source lumineuse LED, température de couleur 3000K. Diffuseur : tube acrylique avec source de lumière LED intégrée. Design tendance et insolite. Construction stable avec base compacte pour un placement proche du mur. Contrôle - bouton de l'interrupteur sur le fil.



MOD099PL-06G

1 ■ MOD277FL-L24GR3K

LED 24 W 2350lm
 t° 3000K >80 Ra 120°
 IP 20

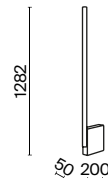

Petra

BS



EN Aluminum body, shade - graphite. Rounded plastic diffuser, large area of uniform and saturated light. LED light source. Color temperature – 3000K. Protection Code IP54.

DE Aluminiumrahmen, Farbe - Graphit. Abgerundeter Diffusor aus Kunststoff - große Fläche von gleichmäßigem und gesättigtem Licht. LED-Lichtquelle. Farbtemperatur - 3000K. Schutzgrad - IP54.

IT Il corpo e' in alluminio, il colore è grafite. Il diffusore arrotondato in plastic e' una vasta area di luce uniforme e ricca. Sorgente luminosa a LED. La temperatura di colore e' 3000K. Il grado di protezione e' IP54.

FR Corps en aluminium, couleur - graphite. Diffuseur en plastique arrondi - une grande zone de lumière uniforme et saturée. Source de lumière LED. Température de couleur - 3000K. Degré de protection - IP54.

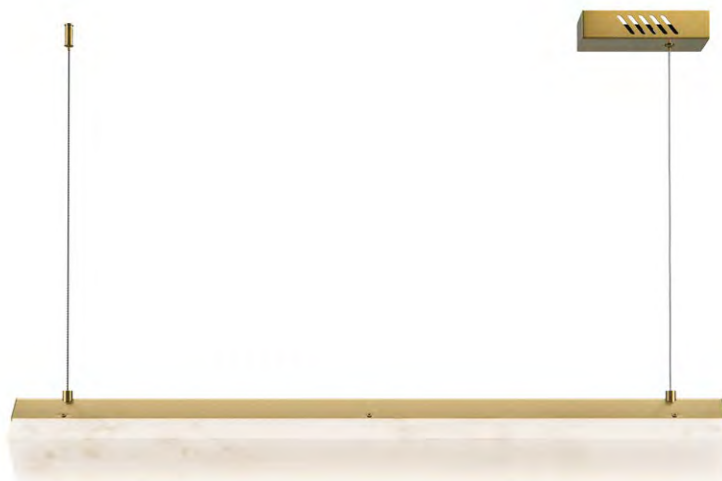

1 ■

1 ■ **MOD250PL-L36BS3K**

LED 35W 2400lm
t° 3000K >80Ra 80°
IP 20

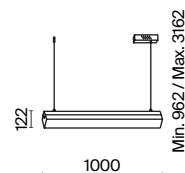



MOD250PL-L36BS3K

Roots

B

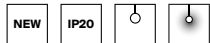

EN Fittings material – metal, shade – black. Lampshade - 5-layer plywood of beige shade, coated with a special lacquer. Fabric black wire. Adjustable height. Simple concise shape, natural materials. E27 base.

DE Material der Beschläge - Metall, Farbton - Schwarz. Lampenschirm - Beigetones 5-Schichtenfurnier, beschichtet mit Speziallack. Schwarzer Textildraht. Einstellbare Höhe. Einfache lakonische Formen, Naturstoffe. E27-Fassung.

IT Il materiale dell'armatura è il metallo, il colore è nero. Il paralume di colore beige e' realizzato in compensato a 5 strati rivestito con una vernice speciale. Tessuto filo in colore di nero. L'altezza e' regolabile. Le forme sono semplici, sottili e laconici, i materiali sono naturali. Il portalampana di E27.

FR Matériel de l'armature - métal, teinte - noir. Abat-jour - contreplaqué à 5 couches de nuance beige, recouvert d'un vernis spécial. Fil noir en tissu. Hauteur réglable. Forme simple et concise, matériaux naturels. Culot E27.



1, 2, 3 ■

1 ■ MOD197PL-01W

💡 1 x E27 40 W
IP 20

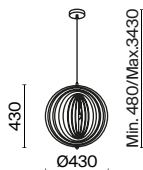

2 ■ MOD197PL-01W1

💡 1 x E27 40 W
IP 20

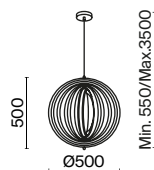

3 ■ MOD197PL-01W2

💡 1 x E27 40 W
IP 20

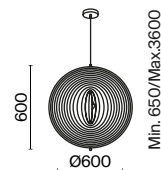



4,5 ■



6,7 ■

4 ■ MOD191PL-01W

1 x E27 40 W
IP 20

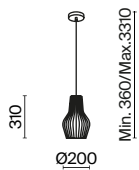

5 ■ MOD191PL-01W1

1 x E27 40 W
IP 20

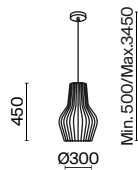

6 ■ MOD192PL-01W

1 x E27 40 W
IP 20

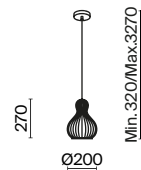

7 ■ MOD192PL-01W1

1 x E27 40 W
IP 20

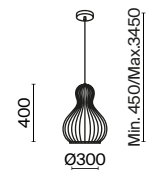

Roots



8, 9 ■



10, 11 ■



12, 13 ■



8 ■ MOD193PL-01W

💡 1 x E27 40 W
IP 20

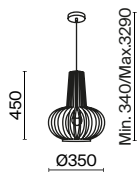

9 ■ MOD193PL-01W1

💡 1 x E27 40 W
IP 20



10 ■ MOD194PL-01W

💡 1 x E27 40 W
IP 20



11 ■ MOD194PL-01W1

💡 1 x E27 40 W
IP 20

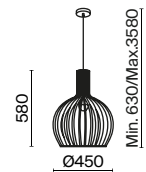



MOD194PL-01WS

MOD193PL-01W1

MOD194PL-01W1

12 ■ MOD195PL-01W

1 x E27 40 W
IP 20

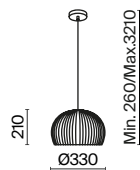

13 ■ MOD195PL-01W1

1 x E27 40 W
IP 20

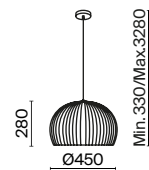

CRYSTAL	P. 402
GLASS	P. 418
METAL	P. 422
FABRIC	P. 424

CLASSIC

Maytoni Decorative



LIGHTING

Maytoni Decorative

Basfor

AG AN



EN Fittings – metal. Electroplating in antique gold or antique nickel color. Decorative elements – diamond cut crystals.

DE Metallbeschläge. Galvanik im Farbton antikes Gold oder antikes Nickel. Dekor: Kristalle mit Diamantschliff.

IT Armatura - metallo. Galvanotecnica in oro antico o nichel antico. Decoro - cristalli a forma di diamante.

FR Armature : métal. Galvanisation de couleur dorée ancien et nickel ancien. Éléments décoratifs : cristaux taillés en losange.



1



2



3



4

1 **DIA100-CL-03-G**
DIA100-CL-03-N

3 x E14 60 W
IP 20

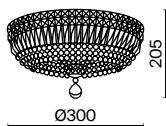

2 **DIA100-CL-12-G**

12 x E14 60 W
IP 20



3 **DIA100-CL-16-G**

16 x E14 60 W
IP 20



4 **DIA100-WL-02-G**
DIA100-WL-02-N

2 x E14 60 W
IP 20

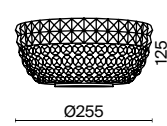



Bella

G

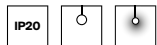

EN Metal fittings, electroplating in gold color. Embossed pattern with white patina. Decorative elements—crystals of various sizes and cuts. Traditional silhouette.

DE Metallbeschläge, galvanisiert in der Farbe Gold. Geprägtes Muster mit weißer Patina. Dekor: Kristalle mit unterschiedlicher Größe und Schliff. Traditionelle Silhouette.

IT Struttura in metallo, galvanizzata in colore oro. Motivo in rilievo con patina bianca. Decoro - cristalli di diverse dimensioni e tagli. Sagoma tradizionale.

FR Armature en métal, galvanisation de couleur dorée. Motif en relief avec une patine blanche. Éléments décoratifs : cristaux de différentes dimensions et tailles. Silhouette traditionnelle.



1



2

1 **DIA750-TT50-WG**

8 × E14 60 W
IP 20

2 **DIA750-TT40-WG**

6 × E14 60 W
IP 20

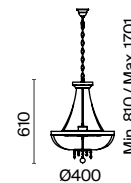
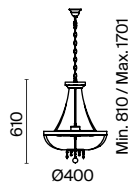

Broche

N

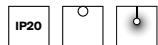

EN Fittings material – metal, color – nickel. Metal lampshades frame is decorated with cut crystals. Compact height.

DE Metallbeschläge, Farbton: Nickel. Metallrahmen des Lampenschirms verziert mit facettierten Kristallen. Kompakte Höhe.

IT Materiale dell'armatura - metallo, colore - nichel. La struttura metallica del paralume è decorata con cristalli sfaccettati. Altezza compatta.

FR Metallbeschläge, Farbton: Nickel. Metallrahmen des Lampenschirms verziert mit facettierten Kristallen. Kompakte Höhe.



1 **DIA902-06-N**

6 × E14 60 W
IP 20

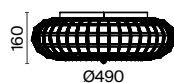

2 **DIA902-04-N**

4 × E14 60 W
IP 20

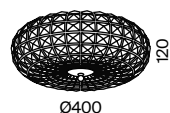

Cascade

G

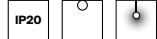

EN Classic series of chandeliers with a cascade of crystals twisted in a spiral. Metal fittings are plated in gold color. The ceiling bowl is framed by a decorative ornament.

DE Klassische Serie von Kronleuchten mit einer spiralförmig verdrehten Kaskade von Kristallen. Metallbeschläge sind galvanisch in Gold beschichtet. Deckenschale, von einem dekorativen Ornament umrahmt.

IT Serie classica di lampadari con cascata di cristalli a spirale. Armatura in metallo galvanizzata in colore oro. La ciotola da soffitto è incorniciata da un ornamento decorativo.

FR Série classique de lustres avec une cascade de cristaux en spirale. Armature métallique recouverte d'un procédé galvanisé de couleur dorée. La vasque du plafond est encadrée par un ornement décoratif.



1



2

1 **DIA522-CL-07-G**

7 x E14 60 W
IP 20

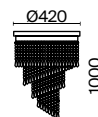

2 **DIA522-CL-12-G**

12 x E14 60 W
IP 20

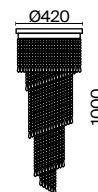



Grace

BS



EN Metal fittings, shades – brass, white with gold. Models with open light sources and with lampshades. Organza lampshades, shades – beige, white. Spiral decorative elements of the central axis. Crystal pendants. Height of the chandeliers is adjustable.

DE Metallbeschläge, Farbtöne: Messing, Weiß mit Gold. Modelle mit offenen Lichtquellen und Lampenschirmen. Lampenschirme aus Organza, Farbtöne: Beige, Weiß. Spiralförmig verdrehter Dekor der Mittelachse. Anhänger aus Kristallen. Einstellbare Höhe der Kronleuchten.

IT Armatura in metallo, tonalità – ottone, bianco con oro. Modelli con sorgenti luminose aperte e con paralumi. Paralumi in organza, tonalità - beige, bianco. Decoro a spirale dell'asse centrale. Pendenti in cristallo. L'altezza dei lampadari è regolabile.

FR Armature métallique, teintes : laiton, blanc avec dorée. Modèles avec sources de lumière ouvertes et abat-jours. Abat-jours en organza, teintes : beige, blanc. Élément décoratif en spirale sur l'axe central. Pendentifs en cristal. Hauteur du lustre réglable.



1



2



3



4



5

1 ■ RC247-PL-10-R

⚡ 10 × E14 60 W
IP 20

2 ■ RC247-PL-08-R

⚡ 8 × E14 60 W
IP 20

3 ■ RC247-WL-01-R

⚡ 1 × E14 60 W
IP 20

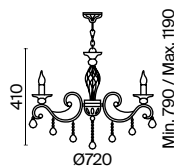
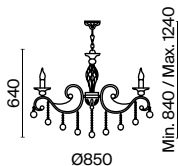



RC247-PL-06-R

4 ■ RC247-WL-02-R

💡 2 × E14 60 W
IP 20

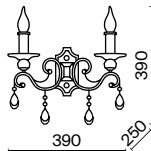

5 ■ RC247-PL-06-R

💡 6 × E14 60 W
IP 20

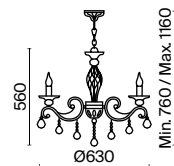

Karolina

G

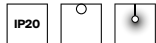

EN Fittings – metal, color – gold. Decorative pendants are fixed on a metal frame. Crystals have various shapes and faceting.

DE Metallbeschläge in Gold. Dekorative Anhänger sind an einem Metallrahmen befestigt. Kristalle mit verschiedenen Formen und Schliff.

IT Armatura - metallo, colore - oro. I pendenti decorativi sono fissati su una struttura di metallo. Cristalli di varie forme e vari tagli.

FR Armature : métal, couleur : dorée. Pendentifs fixés sur carcasse métallique. Cristaux de différentes formes et tailles.



1



2

1 **DIA120-09-G**

9 x E14 40W
IP 20

2 **DIA120-06-G**

6 x E14 40W
IP 20

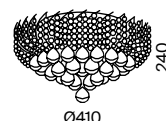
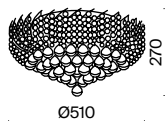



Ottilia

AG

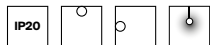

EN Fittings – metal, shade – gold. Ring with perforated ornament. Decorative elements– crystals of various sizes and cuts. The traditional shape of an antique bowl.

DE Metallbeschläge, Farbtöne: Gold, Nickel. Ring mit einem gekerbten Ornament. Dekor: Kristalle mit unterschiedlicher Größe und Schliff. Traditionelle Form einer antiken Schüssel.

IT Armatura - metallo, tonalità - oro. Cerchio con ornamento traforato. Decoro - cristalli di diverse dimensioni e tagli. Forma tradizionale da coppa antica.

FR Armature : métal, teinte : dorée. Cercle avec ornement ajouré. Éléments décoratifs de différentes dimensions et tailles. Vasque ancienne de forme traditionnelle.



1



2



3



4

DIA700-CL-03-G

3 x E14 60W
IP 20



DIA700-CL-06-G

6 x E14 60W
IP 20



DIA700-CL-12-G

12 x E14 60W
IP 20

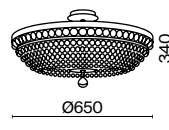

DIA700-WL-02-G

2 x E14 60W
IP 20

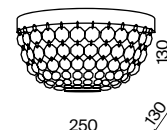

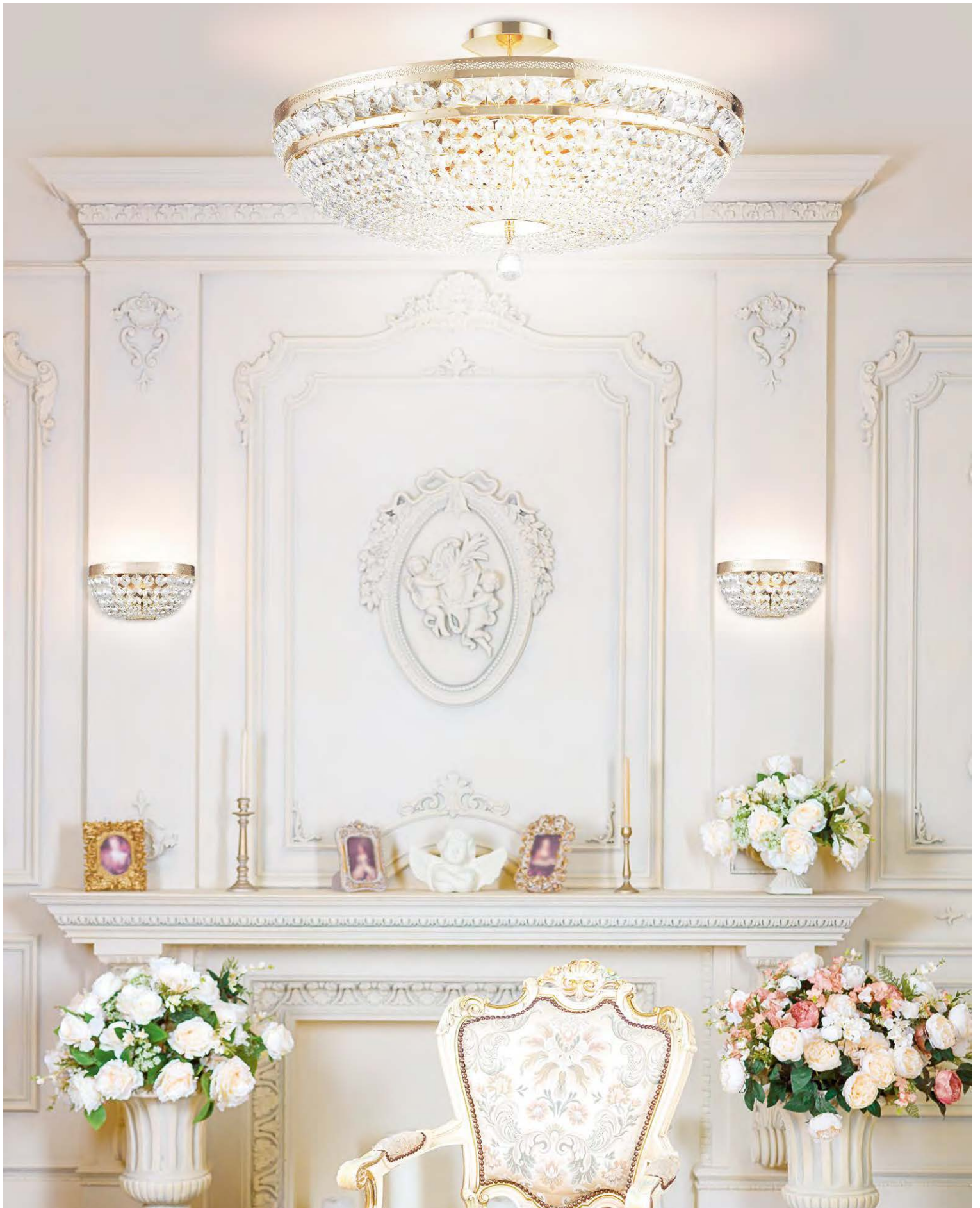

DIA700-WL-02-G

DIA700-CL-12-G

Palace

AG



EN Metal fittings, color – antique gold. Decoration of metal elements – inlaid colorful ornament. Tiered crystal pendants hide lamps.

DE Metallbeschläge, Farbton: Antikes Gold. Dekor der metallischen Elemente: ein eingelegtes florales Ornament. Mehrstufige Kristallanhänger verdecken die Leuchtmittel.

IT Armatura in metallo, colore oro antico. Decoro degli elementi in metallo: ornamento floreale intarsiato. I pendenti in cristallo a strati nascondono le lampade.

FR Armature en métal, couleur: dorée ancien. Décoration des éléments métalliques : ornement floral incrusté. Les pendentifs en cristal sur plusieurs niveaux dissimulent les ampoules.



1



2



3



4



5

1 **DIA890-CL-18-G**

18 x E27 60 W
IP 20

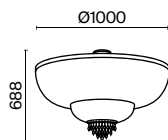

2 **DIA890-CL-06-G**

6 x E27 60 W
IP 20

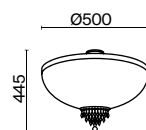

3 **DIA890-WL-01-G**

1 x E27 60 W
IP 20

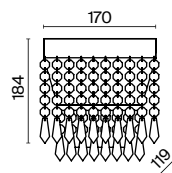



DIA891-CL-14-G

4  **DIA890-CL-05-G**

💡 5 x E27 60 W
IP 20

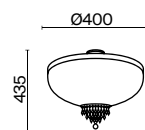
5  **DIA891-CL-14-G**

💡 14 x E27 60 W
IP 20

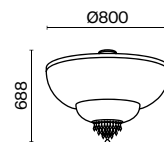

Sevilla

G

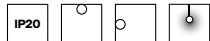

EN Fittings material— metal. Color – gold. Decorative crystals of various shapes and faceting. Universal mount 2 in 1. Adjustable chain length for pendant models.

DE Metallbeschläge, Farbton: Gold. Dekorative Kristalle mit verschiedenen Formen und Schliff. Universelle 2-in-1-Befestigung Einstellbare Länge der Kette der Pendelmodelle.

IT Materiale dell'armatura – metallo. Colore: oro. Cristalli decorativi di diversi forme e tagli. Fissaggio universale 2 in 1. Lunghezza della catena regolabile per modelli a sospensione.

FR Matériau de l'armature : métal. Couleur : dorée. Cristaux décoratifs de différentes formes et tailles. Fixation universelle 2 en 1. Longueur de la chaîne réglable pour les modèles de suspensions.



1



2



3

1 **DIA004-08-G**

8 x E14 60W
IP 20

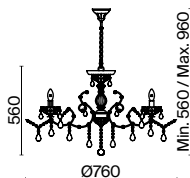

2 **DIA004-06-G**

6 x E14 60W
IP 20

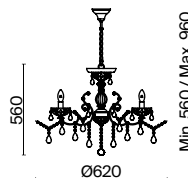

3 **DIA004-01-G**

1 x E14 60W
IP 20

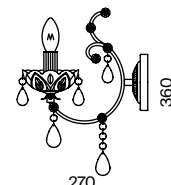

Toils

G

IP20



EN Metal frame. Shade – gold. Steel cables are adjustable in height. Crystal pendants.

DE Metallrahmen. Farbton: Gold. Stahlseile sind in der Höhe verstellbar. Anhänger aus Kristall.

IT Struttura metallica. Colore: oro. L'altezza dei cavi in acciaio è regolabile. Pendenti in cristallo.

FR Carcasse en métal. Teinte : dorée. Câbles acier réglables en hauteur. Pendentifs en cristal.



1 ■ DIA600-07-G

💡 7 x E14 60 W
IP 20

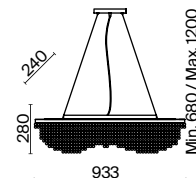

Combinare

ABZ

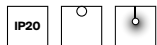

EN Round metal frame of antique bronze color. Dome lamp of white frosted glass. Light source – lamp with E27 base.

DE Runder Metallrahmen, Farbton: antike Bronze. Lampenschirm aus weißem Milchglas. Lichtquelle: Leuchtmittel mit E27-Fassung.

IT Armatura tonda in metallo color bronzo antico. Plafoniere in vetro opaco bianco. La sorgente luminosa è una lampadina con attacco E27.

FR Carcasse ronde en métal teinte bronze ancien. Globe en verre mat blanc. Source de lumière : ampoule à culot E27.



C232-CL-03-R

1 ■ C232-CL-03-R

💡 3 × E27 60 W
IP 20

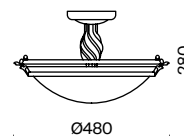

Kiwi

BS

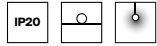

EN Fittings material – metal, color – brass. Glass dome lamp of combined glass. Shade – green. Colored in white inside. Classic silhouette. Light source – lamp with E27 base.

DE Metallbeschläge, Farbton: Messing. Lampenschirm aus kombiniertem Glas. Farbton: Grün. Von innen weiß gefärbt. Klassische Silhouette. Lichtquelle: Leuchtmittel mit E27-Fassung.

IT Materiale dell'armatura - metallo, colore - ottone. Plafoniera in vetro combinato. Tonalità - verde. L'interno è tinto di bianco. Sagoma classica. La sorgente luminosa è una lampadina con attacco E27.

FR Matériau de l'armature: métal, couleur : laiton. Globe en verre combiné. Teinte : vert. Intérieur teinté en blanc. Silhouette classique. Source de lumière : ampoule à culot E27.



Z153-TL-01-BS

1 ■ **Z153-TL-01-BS**

💡 1 x E27 40W
IP 20

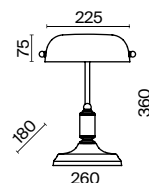

Pascal

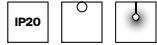

EN Metal fittings, shades – antique bronze, white with gold. Dome lamp – frosted glass, sandblasting pattern. Rim and tip with pressed ornament.



DE Metallbeschläge, Farbtöne: antike Bronze, Weiß mit Gold. Lampenschirm: Milchglas, Sandstrahlmuster. Felge und Spitze mit gepresstem Ornament.

IT Armatura in metallo, tonalità – bronzo antico, bianco con oro. Plafoniera – vetro opaco, disegno sabbato. Bordo e puntale con ornamento pressato.

FR Armature métallique, teinte : bronze ancien, blanc avec dorée. Globe en verre mat avec dessin par jet de sable. Cerclage et extrémité avec ornement gaufré.



1 

1  **C908-CL-03-R**
 **C908-CL-03-W**

 3 × E27 40 W
 IP 20



Zeil

BZ

IP43



EN Metal fittings in bronze color. Dome lamp – transparent blown glass with metal frame. Light source – lamp with E27 base.

DE Metallbeschläge in Bronze. Lampenschirm: transparentes geblasenes Glas mit einem Metallrahmen. Lichtquelle: Leuchtmittel mit E27-Fassung.

IT Armatura in metallo color bronzo. Plafoniera - vetro soffiato trasparente con struttura in metallo. La sorgente luminosa è una lampadina con attacco E27.

FR Armature métallique de couleur bronze. Globe en verre soufflé transparent avec carasse métallique. Source de lumière : ampoule à culot E27.



1 ■

1 ■ **H356-CL-03-BZ**

⚡ 3 × E27 60W
IP 43

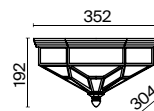

Perla

G
CR



EN Metal fittings, color – gold with cream accents. Decorative horns with floral elements. Candle-shaped light sources. Height of the chandelier is adjustable by the length of the chain.

DE Metallbeschläge, Farbton: Gold mit cremefarbenen Einsätzen. Dekorative Arme mit floralen Elementen. Kerzenförmige Lichtquellen. Durch die Länge der Kette einstellbare Höhe der Kronleuchte.

IT Armatura in metallo, colore – oro con inserti color crema. Luci decorative con elementi floreali. Sorgenti luminose sotto forma di candele. L'altezza del lampadario è regolata dalla lunghezza della catena.

FR Armature métallique, couleur dorée avec des incrustations crème. Bras décoratifs avec éléments floraux. Sources de lumière en forme de bougies. Hauteur du lustre réglable par une longue chaîne.



1



2

1 **ARM337-02-R**

💡 2 × E14 60W
IP 20

2 **ARM337-05-R**

💡 5 × E14 60W
IP 20

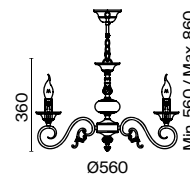
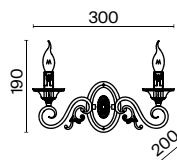



ARM337-05-R

Alicante

N



EN Fittings material – metal, color – nickel. Lampshades made of white fabric on PVC. Decor of the central part and horns – transparent cast glass with corrugated texture. The height of the chandelier is adjustable by the length of the chain.

DE Metallbeschläge, Farbton: Nickel. PVC-Lampenschirme aus weißem Stoff. Dekor des zentralen Teils und der Arme: transparentes gegossenes Glas mit geriffelter Textur. Durch die Länge der Kette einstellbare Höhe der Kronleuchte.

IT Materiale dell'armatura - metallo, colore - nichel. Paralumi in tessuto bianco su PVC. Il decoro della parte centrale e delle luci è in vetro colato trasparente goffrato. L'altezza del lampadario è regolata dalla lunghezza della catena.

FR Matériau de l'armature: métal, couleur : nickel. Abat-jours en tissu blanc sur PVC. Élément décoratif de la partie centrale et des bras en verre coulé transparent texturé. Hauteur du lustre réglable par une longue chaîne.



1



2



3



4

MOD014CL-06N

6 x E14 40 W
IP 20

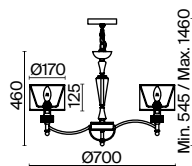

MOD014WL-01N

1 x E14 40 W
IP 20

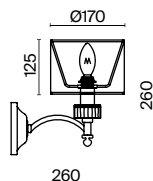

MOD014TL-01N

1 x E14 40 W
IP 20

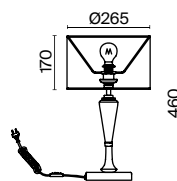

MOD014FL-01N

1 x E27 40 W
IP 20

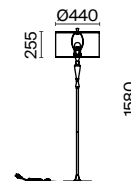



Anna

AG



EN Antique gold fittings, material – metal. Lampshade of cream textile, applied to PVC. Frame and decorative elements of composition in the form of metal rings. Height of pendant models is adjustable.

DE Beschläge im Farbton antikes Gold, Material: Metall. Lampenschirm aus cremefarbenem Textil, auf PVC aufgetragen. Rahmen und Dekor der Komposition in Form von Metallringen. Einstellbare Höhe der Pendelmodelle.

IT L'armatura è di tonalità oro antico, il materiale è metallo. Paralume in tessuto panna applicato su PVC. Struttura e decoro della composizione a forma di anelli di metallo. L'altezza dei modelli a sospensione è regolabile.

FR Armature en teinte dorée ancien, matériau : métal. Abat-jour en textile crème appliqué sur PVC. Carcasse et élément décoratif de la composition sous forme d'anneaux métalliques. Hauteur des modèles de suspensions réglable.



1



2



3

1 **H007PL-04G**

4 × E14 40 W
IP 20

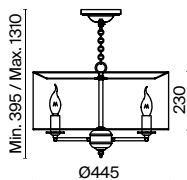

2 **H007PL-05G**

5 × E14 40 W
IP 20

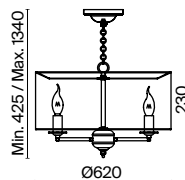

3 **H007WL-01G**

1 × E14 40 W
IP 20

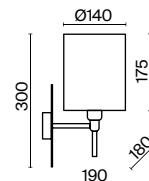



Albero

BG

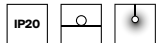

EN Decorative polyresin elements precisely imitate wood carving. Lampshades made of cotton on PVC and metal fittings harmoniously match with the decor.

DE Dekorelemente aus Polyresin imitieren Holzschnitzereien möglichst genau. Lampenschirme aus Baumwolle auf PVC und Metallbeschläge passen harmonisch mit dem Dekor zusammen.

IT Gli elementi decorativi realizzati in poliresina imitano incisione in legno nel modo più accurato possibile. I paralumi in cotone di PVC (polivinilcloruro) e l'armatura metallica si armonizza perfettamente con l'arredamento circostante.

FR Les éléments décoratifs en polyrésine imitent le plus précisément possible la gravure sur bois. Les abat-jour en coton sur PVC et les l'armature métallique se marient harmonieusement au décor.



H034-WL-02-R

1 ■ H034-WL-02-R

💡 2 × E14 40 W
IP 20

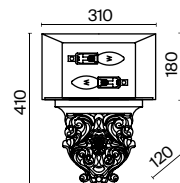

Brionia

EN Fittings material – metal, color – beige. White organza lampshades are made using winding technology. Clear crystal decorative pendants.

DE Metallbeschläge, Farbton: Beige. Weiße Lampenschirme aus Organza sind in der Wickeltechnik hergestellt. Dekorativ Pendelleuchten aus transparenten Kristallen.

IT Materiale dell'armatura - metallo, colore - beige. I paralumi in organza bianca sono realizzati utilizzando la tecnologia dell'avvolgimento. Pendenti decorativi in cristalli trasparenti.

FR Matériau de l'armature : métal, couleur : beige. Abat-jours blancs en organza réalisés par enroulement. Pendentifs décoratifs en cristaux transparents.

BG

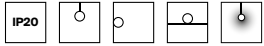

1



2



3

1 ■ **ARM172-05-G**

⚡ 5 × E14 40W
IP 20

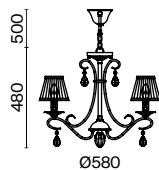
2 ■ **ARM172-01-G**

⚡ 1 × E14 40W
IP 20

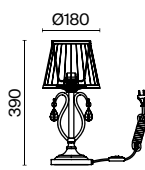
3 ■ **ARM172-02-G**

⚡ 2 × E14 40W
IP 20



Grace

BS W
G

IP20   

EN Metal fittings, shades – brass, white with gold. Models with open light sources and with lampshades. Organza lampshades, shades – beige, white. Spiral decorative elements of the central axis. Crystal pendants. Height of the chandeliers is adjustable.

DE Metallbeschläge, Farbtöne: Messing, Weiß mit Gold. Modelle mit offenen Lichtquellen und Lampenschirmen. Lampenschirme aus Organza, Farbtöne: Beige, Weiß. Spiralförmig verdrehter Dekor der Mittelachse. Anhänger aus Kristallen. Einstellbare Höhe der Kronleuchten.

IT Armatura in metallo, tonalità – ottone, bianco con oro. Modelli con sorgenti luminose aperte e con paralumi. Paralumi in organza, tonalità - beige, bianco. Decoro a spirale dell'asse centrale. Pendenti in cristallo. L'altezza dei lampadari è regolabile.

FR Armature métallique, teintes : laiton, blanc avec dorée. Modèles avec sources de lumière ouvertes et abat-jours. Abat-jours en organza, teintes : beige, blanc. Élément décoratif en spirale sur l'axe central. Pendentifs en cristal. Hauteur du lustre réglable.



1



2



3

1 **ARM247-08-G**

8 × E14 40W
IP 20

2 **ARM247-06-G**

6 × E14 40W
IP 20

3 **ARM247-01-G**

1 × E14 40W
IP 20

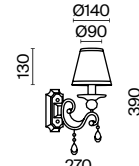
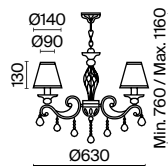
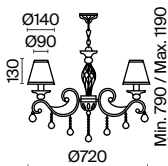



4



5



6

4 **ARM247-10-G**

💡 10 x E14 40 W
IP 20

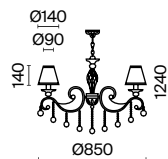

5 **ARM247-PL-01-G**

💡 1 x E14 60 W
IP 20

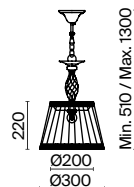

6 **ARM247-02-G**

💡 2 x E14 40 W
IP 20

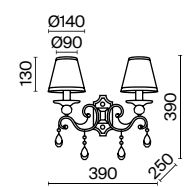



7



8

7 **RC247-FL-01-R**
 ARM247-11-G

💡 1 × E14 40 W
 IP 20

8 **RC247-TL-01-R**
 ARM247-00-G

💡 1 × E14 40 W
 IP 20

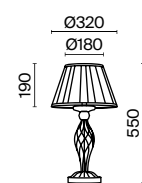



Messina

G

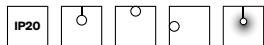

EN Metal fittings of gold color. Lampshade – natural linen on PVC. Metal ornament encircles lampshade. Frosted diffuser.

DE Metallbeschläge in Gold. Lampenschirm: Naturleinen auf PVC aufgetragen. Ein Metallornament umgibt den Lampenschirm. Matter Diffusor.

IT Armatura in metallo color oro. Paralume - lino naturale su PVC. Un ornamento di metallo circonda il paralume. Diffusore opaco.

FR Armature en métal de couleur dorée. Abat-jour en lin naturel sur PVC. Une ornement métallique entoure l'abat-jour. Diffuseur mat.



1



2



3



4

1 **H223-PL-05-G**

5 x E27 60 W
IP 20

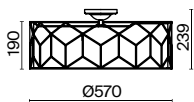

2 **H223-PL-03-G**

3 x E27 60 W
IP 20

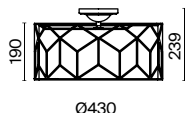

3 **H223PL-03G**

4 x E27 40 W
IP 20

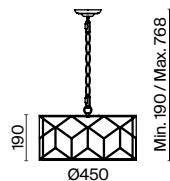

4 **H223-WL-01-G**

1 x E14 40 W
IP 20

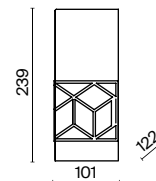



Venera

BS

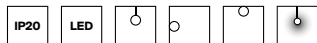

EN Metal fittings, color – brass. Lampshade – cotton on PVC. Wall dome lamp – white glass. Decorative elements – metal ring with perforated ornament. Ceiling model with diffuser. Height of pendant lamps is adjustable.

DE Metallbeschläge, Farbton: Messing. Lampenschirm: Baumwolle auf PVC aufgetragen. Lampenschirm der Wandleuchte: weißes Glas. Dekor: ein Metallring mit einem gekerbten Ornament. Deckenmodell mit Diffusor. Einstellbare Höhe der Pendelleuchte.

IT Armatura in metallo, colore ottone. Paralume - cotone su PVC. Plafoniera dell'applique - vetro bianco. Decoro - un cerchio di metallo con un ornamento traforato. Modello da soffitto con diffusore. L'altezza delle lampade a sospensione è regolabile.

FR Armature en métal, couleur: laiton. Abat-jour : coton sur PVC. Globe applique en verre blanc. Élément décoratif : cercle métallique avec ornement ajouré. Modèles pour plafond avec diffuseur. Hauteur des suspensions réglable.



1



3



4

1 ■ **H260-03-N**

3 × E14 40 W
IP 20

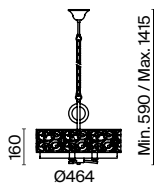

2 ■ **H260-05-N**

5 × E27 60 W
IP 20

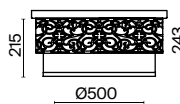

3 ■ **H260-02-N**

2 × E14 40 W
IP 20

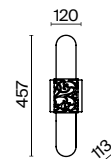



Vittoria

G
CR

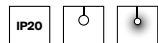

EN Metal fittings, color – creamy with gold tint. Lampshades of cream textile, applied to PVC. Decorative elements – perforated ornament. Light source – lamps with E14 base.

DE Metallbeschläge, Farbton: Creme mit Gold. Lampenschirme aus cremefarbenem Textil, auf PVC aufgetragen. Dekor: gekerbtes Ornament. Lichtquelle: Leuchtmittel mit E14-Fassung.

IT Armatura in metallo, colore - crema con oro. Paralumi in tessuto color crema applicato su PVC. Decoro - ornamento traforato. Sorgente luminosa - lampadine con attacco E14.

FR Armature en métal, couleur crème avec dorée. Abat-jours en textile crème appliqué sur PVC. Élément de décoration : ornement perforé. Source de lumière : ampoules à culot E14.



1 ■

1 ■ **H004CL-05BG**

💡 5 × E14 40 W
IP 20

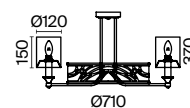



H004CL-05BG

Zaragoza

EN Metal fittings, plated in brass color. Some of the elements are colored black. Lampshades of white textile, applied to PVC. Light source – lamps with E14 base.

DE Metallbeschläge, galvanisiert im Farbton Messing. Ein Teil der Elemente ist schwarz gefärbt. Lampenschirme aus weißem Textil, auf PVC aufgetragen. Lichtquelle: Leuchtmittel mit E14-Fassung.

IT Armatura metallica galvanizzata in colore ottone. Alcuni degli elementi sono tinti di nero. Paralumi in tessuto bianco applicati su PVC. Sorgente luminosa - lampadine con attacco E14.

FR Armature métallique galvanisée en couleur laiton. Partie des éléments teinte en couleur noire. Abat-jours en textile blanc appliqué sur PVC. Source de lumière : ampoules à culot E14.

BS



1



2



3



4

1 **H001CL-05BS**

5 x E14 40 W
IP 20

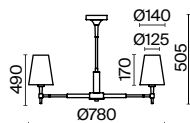

2 **H001WL-01BS**

1 x E14 40 W
IP 20

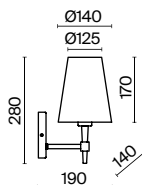

3 **H001CL-07BS**

7 x E14 40 W
IP 20

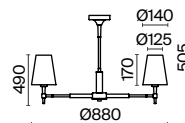

4 **H001TL-01BS**

1 x E14 40 W
IP 20

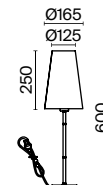

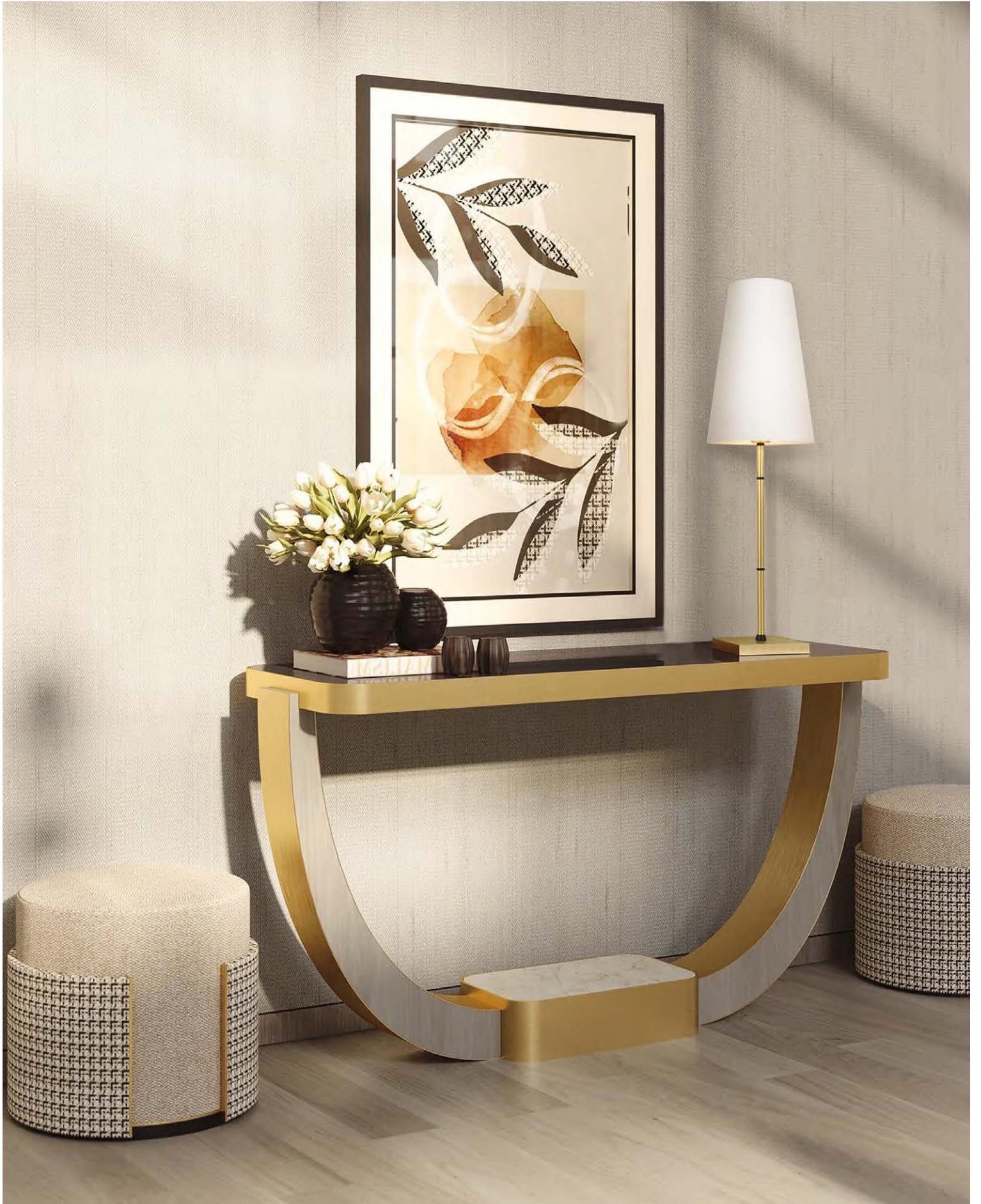

H001TL-01BG

BACKLIGHT

P. 444

BACKLIGHT

Backlight

442

KLIGHT

Maytoni Decorative

Bris

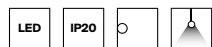

EN Metal and plastic body, shades – white and black. LED light sources with a comfortable color temperature of 4000K. Swivel diffuser for key-lighting.

DE Beschläge aus Metall und Kunststoff, Farbtöne: Weiß und Schwarz. LED-Lichtquellen mit einer angenehmen Farbtemperatur von 4000K. Drehbarer Diffusor für gerichtete Beleuchtung.

IT Corpo in metallo e plastica, tonalità – bianco e nero. Sorgenti luminose a LED con temperatura di colore confortevole di 4000K. Diffusore ruotabile per illuminazione direzionale.

FR Corps en métal et en plastique, teintes: blanc et noir. Sources de lumière LED avec une température de couleur confortable de 4000K. Diffuseur pivotant pour l'applique orientable.



- 1 ■ **MIRO08WL-L12B4K**
□ **MIRO08WL-L12W4K**

LED 12W 820lm
t° 4000K >80Ra 120°
IP 20

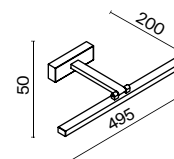

Decart

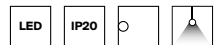

EN Metal body in two colors: white and black. Acrylic diffuser. LED sources with color temperature of 4000K. The light is directed to the wall.

DE Metallrahmen in zwei Farbtönen: Weiß und Schwarz. Acryl-Diffusor. LED-Lichtquellen mit einer Farbtemperatur von 4000K. Das Licht ist auf die Wand gerichtet.

IT Corpo in metallo di due tonalità: bianco e nero. Diffusore in acrilico. Sorgenti LED con temperatura di colore 4000K. La luce è diretta verso il muro.

FR Corps métallique en deux teintes : blanc et noir. Diffuseur acrylique. Sources de lumière LED avec une température de couleur de 4000K. Lumière dirigé vers le mur.



- 1 ■ **MIR010WL-L12B4K**
 □ **MIR010WL-L12W4K**

LED 12W 800lm
 t° 4000K >80Ra 120°
 IP 20

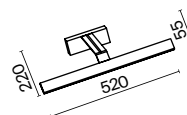

Epic

CH

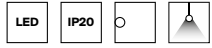

EN Metal body, shade – chrome. LED module hidden under acrylic diffuser. Color temperature is 4000K. Bidirectional light flux.

DE Metallrahmen, Farbton: Chrom. LED-Modul ist unter einem Acryl-Diffusor verborgen. Farbtemperatur 4000K. Bidirektionaler Lichtstrom.

IT Corpo in metallo, tonalità: cromo. Il modulo LED è nascosto sotto un diffusore in acrilico. Temperatura di colore 4000K. Flusso luminoso bidirezionale.

FR Corps en métal, teinte : chrome. Module LED dissimulé sous le diffuseur acrylique. Température de couleur : 4000K. Flux lumineux bidirectionnel.



1 **MIR009WL-L16CH4K** 2 **MIR009WL-L12CH4K**

LED 16 W 900lm
 t° 4000K >80Ra 120°
 IP 20

LED 12 W 650lm
 t° 4000K >80Ra 120°
 IP 20

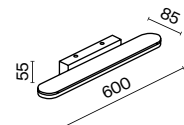
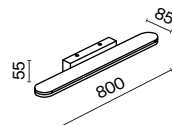

Fichte

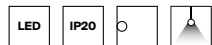

EN Metal and plastic body in two colors: white and black. LED light sources are hidden under the acrylic diffuser. Color temperature is 4000K.

DE Beschläge aus Metall und Kunststoff in zwei Farbtönen: Weiß und Schwarz. LED-Lichtquellen sind unter dem Acryl-Diffusor verdeckt. Farbtemperatur 4000K.

IT Corpo in metallo e plastica di due tonalità: bianco e nero. Le sorgenti luminose a LED sono nascoste sotto un diffusore in acrilico. Temperatura di colore 4000K.

FR Corps en métal et en plastique en deux teintes : blanc et noir. Sources de lumière LED dissimulées sous le diffuseur acrylique. Température de couleur de 4000K.



- 1 ■ **MIR012WL-L14B4K**
 □ **MIR012WL-L14W4K**

LED 14W 950lm
 t° 4000K >80Ra 120°
 IP 20

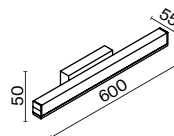

Fino

CH

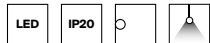

EN Metal body, color – chrome. Diffuser made of durable PC plastic. Light source – LED module. Color temperature is 3000K. Swivel hinge for key-lighting.

DE Metallrahmen, Farbton: Chrom. Diffusor aus strapazierfähigem PC-Kunststoff. Die Lichtquelle ist ein LED-Modul. Farbtemperatur 3000K. Drehbares Scharnier für gerichtete Beleuchtung.

IT Corpo in metallo, colore - cromo. Diffusore in plastica PC resistente. La sorgente luminosa è un modulo LED. Temperatura di colore 3000K. Snodo girevole per illuminazione direzionale.

FR Corps métallique, couleur : chrome. Diffuseur en plastique PC solide. Source de lumière : module LED. Température de couleur : 3000K. Charnière pivotante pour l'orientation de l'éclairage.



1



2

1 **MIR003WL-L16CH**

LED 16 W 1200lm
 t° 3000K >80Ra 120°
 IP 20

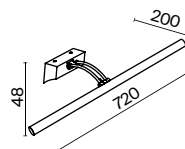

2 **MIR003WL-L12CH**

LED 12,1W 860lm
 t° 3000K >80Ra 120°
 IP 20

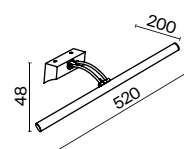

Orion

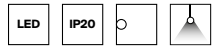

EN Metal body in three colors: white, black, silver. Acrylic diffuser. LED sources with color temperature of 4000K.

DE Metallrahmen in drei Farbtönen: Weiß, Schwarz und Silber. Acryl-Diffusor. LED-Lichtquellen mit einer Farbtemperatur von 4000K.

IT Corpo in metallo di tre tonalità: bianco, nero, argento. Diffusore in acrilico. Sorgenti LED con temperatura di colore 4000K.

FR Corps métallique en trois teintes: blanc, noir, argent. Diffuseur acrylique. Sources de lumière LED avec une température de couleur de 4000K.



- 1 ■ **MIR011WL-L9B4K**
- **MIR011WL-L9S4K**
- **MIR011WL-L9W4K**

LED 14W 950lm
 t° 4000K >80Ra 120°
 IP 20

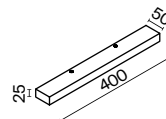

Finelli

B BZ

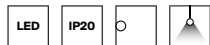

EN Metal body in black and bronze color. Diffuser made of PC plastic. LED module, color temperature is 3000K. Swivel hinge directs the light at the desired angle.

DE Metallrahmen in Schwarz und in Bronze. Diffusor aus PC-Kunststoff. LED-Modul mit einer Farbtemperatur von 3000K. Drehbares Scharnier lenkt das Licht in den gewünschten Winkel.

IT Corpo in metallo colore nero e bronzo. Diffusore in PC. Modulo LED, temperatura di colore 3000K. La cerniera girevole dirige la luce all'angolazione desiderata.

FR Corps métallique de couleur noire et bronze. Diffuseur en plastique PC. Module LED, température de couleur 3000K. Charnière pivotante pour orienter la lumière selon l'angle désiré.



1 ■ ■

1 ■ **MIR004WL-L12B**
■ **MIR004WL-L12BZ**

LED 12,1W 800lm
t° 3000K >80 Ra 120°
IP 20

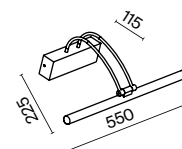

Govanni

BZ

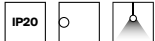

EN Metal fittings in bronze color. Ribbed body. Mechanical hinges for adjusting the backlight angle.

DE Metallbeschläge in Bronze. Gerippter Korpus. Mechanische Scharniere zum Einstellen des Beleuchtungswinkels.

IT Armatura in metallo color bronzo. Corpo costolato. Cerniere meccaniche per la regolazione dell'angolo di illuminazione.

FR Armature métallique de couleur bronze. Corps nervuré. Charnières mécaniques pour le réglage de l'angle de l'éclairage.



1 ■

1 ■ **PIC119-44-R**

⚡ 4 × E14 25W
IP 20

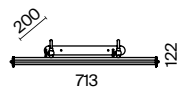

Picasso

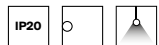

EN Decorative metal body in three shades: white, bronze and gold. Base in the form of a classic rosette. Tilt angle of the backlight is adjusted by a mechanical hinge mounted on the bracket.

DE Dekorativer Metallrahmen in 3 Farbtönen: Weiß, Bronze und Gold. Sockel in Form einer klassischen Steckdose. Der Winkel der Hintergrundbeleuchtung wird durch ein mechanisches Scharnier an der Halterung eingestellt.

IT Struttura metallica decorativa in tre tonalità: bianco, bronzo e oro. Piede a rosetta classica. L'inclinazione dell'illuminazione è regolata da una cerniera meccanica montata sulla staffa.

FR Corps métallique décoratif en trois teintes : blanc, bronze et dorée. Base de la forme d'une rosace classique. Angle d'inclinaison de l'éclairage réglable par une charnière mécanique montée sur le support.



- 1 **PIC114-02-W**
- PIC114-02-R**
- PIC114-02-G**

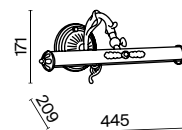

2 x E14 25W
IP 20

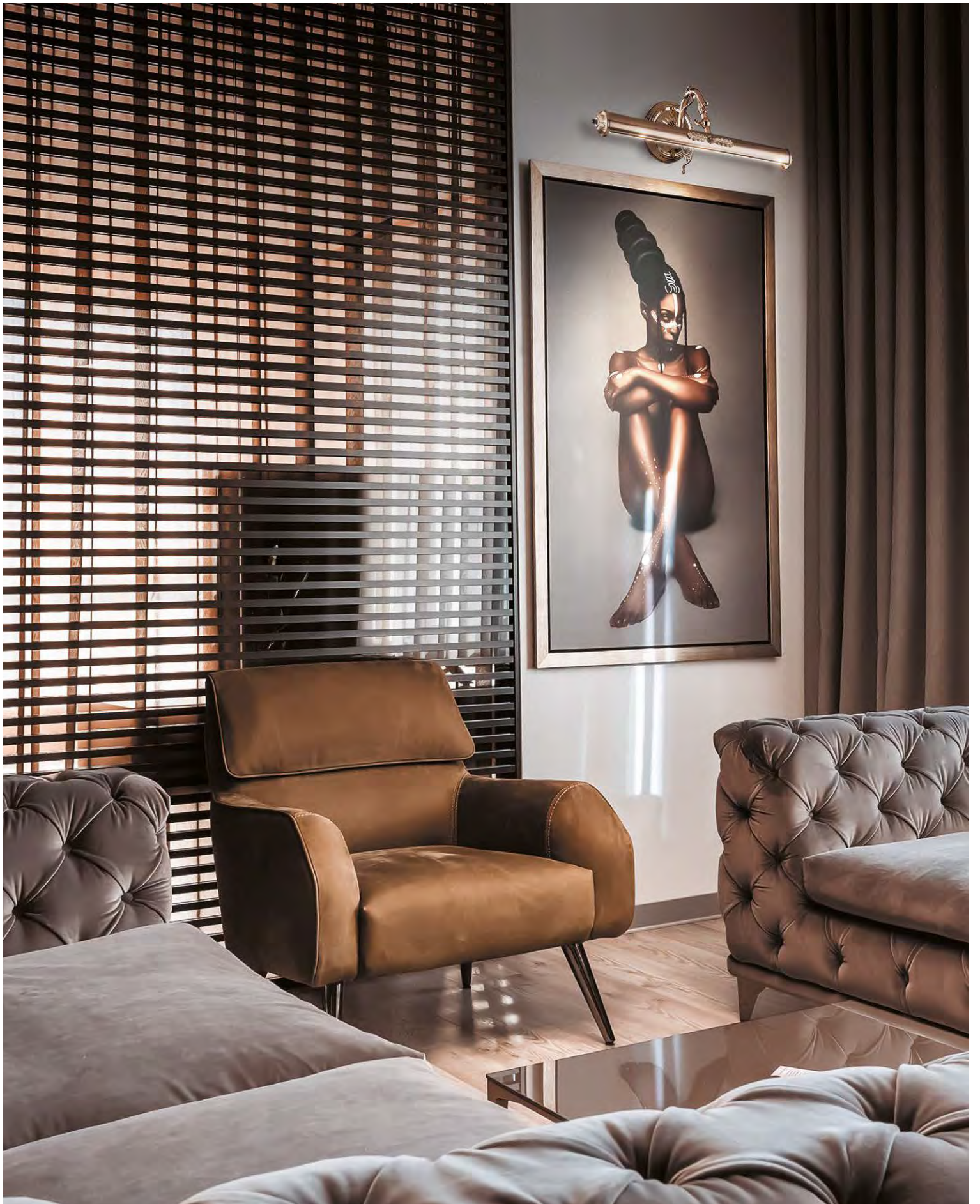



Renoir

W BZ

IP20  

EN Fittings – metal, color – bronze. Ribbed body, embossed base. Mechanical hinge on the bracket adjusts backlight angle.

DE Metallbeschläge in Bronze. Gerippter Korpus, Sockel mit geprägtem Muster. Ein mechanisches Scharnier an der Halterung reguliert den Beleuchtungswinkel.

IT Armatura - metallo, colore - bronzo. Corpo costolato, piede con motivo in rilievo. Una cerniera meccanica sulla staffa regola l'angolo dell'illuminazione.

FR Armature: métal, couleur : bronze. Corps nervuré, base avec dessin en relief. La charnière mécanique sur le support règle l'angle de l'éclairage.



1  

1  **PIC118-22-R**
 **PIC118-22-W**

 2 × E14 25 W
 IP 20





SPECTACULAR MOMENTS

Maytoni Decorative

OF OUTDOOR LIGHTING

Maytoni Outdoor

Three critical questions

Drei entscheidende Fragen

A meticulous approach to lighting design will:

Eine sorgfältige Herangehensweise an die Lichtgestaltung soll:

1. Enhance the comfort of functional areas

Den Komfort der Funktionsbereiche verbessern

2. Accentuate the allure of landscape design and architectural features

Die Attraktivität von Landschaftsgestaltung und architektonischen Merkmalen hervorheben

3. Elevate safety

Die Sicherheit erhöhen

What is the lighting's purpose?

Was ist der Zweck der Beleuchtung?

What are the elements we intend to illuminate?

Welche Elemente sollen beleuchtet werden?

What product is best suited for the application?

Welches Produkt ist für die Anwendung am besten geeignet?

Following this order is really important. Firstly we need to grasp the role that light plays, then its integration within the architectural landscape, and finally to determine the appropriate luminaires and how many are required.

Die Einhaltung dieser Reihenfolge ist sehr wichtig. Zunächst müssen wir die Rolle des Lichts begreifen, dann seine Integration in die architektonische Landschaft und schließlich die geeigneten Leuchten und die Anzahl der benötigten Leuchten bestimmen.

Spend quality time with the children and recapture your youth

Host a family barbecue

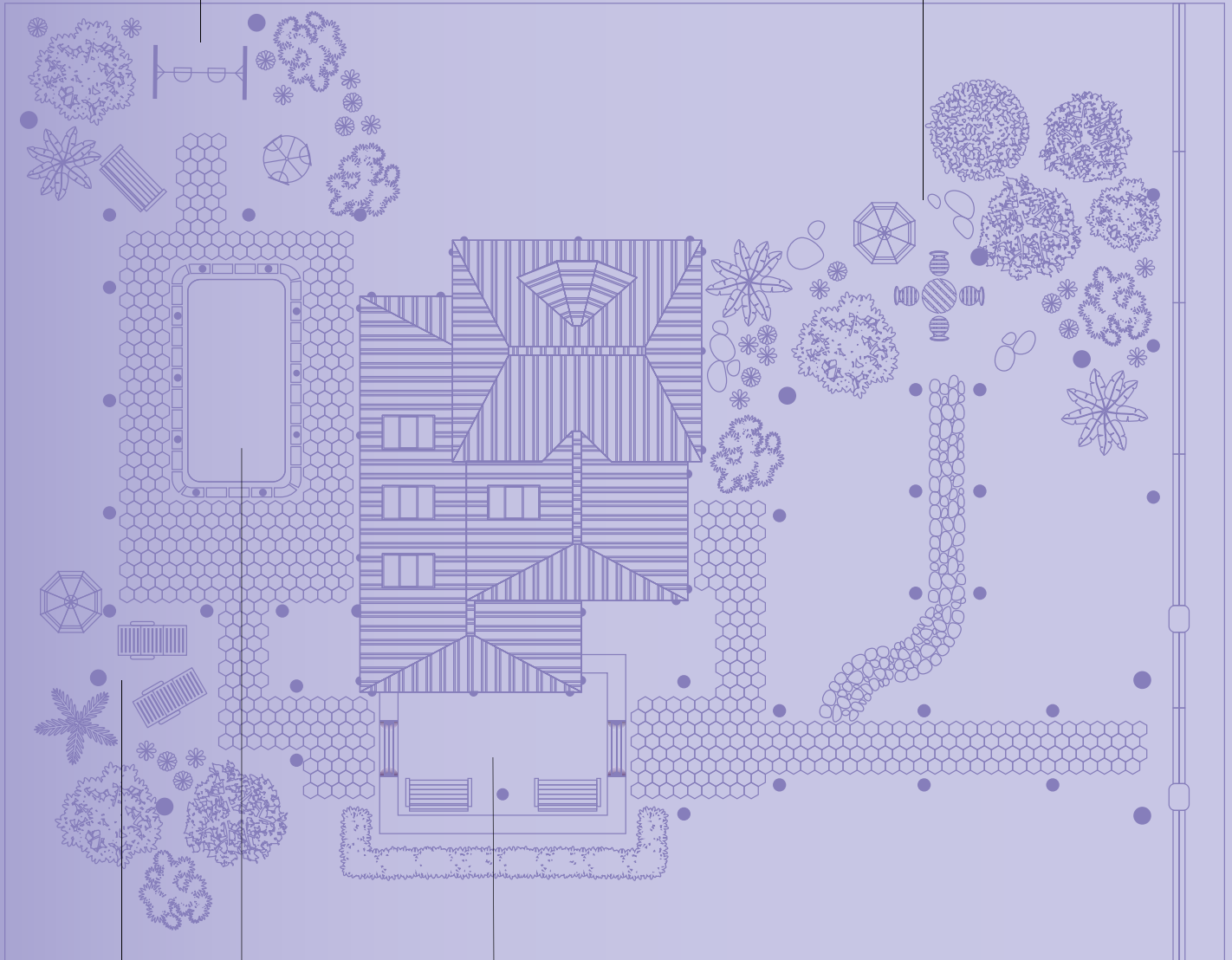

Bask in the sun with a good read

Enjoy a refreshing swim on a scorching day

Enjoy the beauty of a summer's evening

Three layers of illumination

Drei Beleuchtungsebenen

For comprehensive spatial illumination, a layered approach to outdoor lighting is paramount.

Für eine umfassende räumliche Beleuchtung ist ein mehrschichtiger Ansatz bei der Außenbeleuchtung von größter Bedeutung.



● General lighting

Allgemeine Beleuchtung

(Featuring large and medium-sized landscape poles and wall luminaires)

(mit großen und mittelgroßen Landschaftsmasten und Wandleuchten)

This foundational layer provides ample illumination for orientation, both during the twilight hours and at night, ensuring clarity of site boundaries and general navigation.

Diese grundlegende Beleuchtungsschicht bietet sowohl in der Dämmerung als auch in der Nacht eine ausreichende Beleuchtung zur Orientierung und sorgt für eine klare Abgrenzung des Geländes sowie für allgemeine Orientierung.

○ Functional or marker lighting

Funktionale Beleuchtung oder Markierungsbeleuchtung

(Comprising small landscape poles, recessed luminaires, stair lighting, pendant, and ceiling lights)

(bestehend aus kleinen Landschaftsmasten, Einbauleuchten, Treppenbeleuchtung, Pendel- und Deckenleuchten)

This layer introduces directional light to define zones, streamline navigation, and guarantee safe movement throughout the area, including vehicular access and egress.

Hier wird gerichtetes Licht eingesetzt, um Zonen abzugrenzen, die Orientierung zu erleichtern und die Sicherheit im gesamten Gebiet zu gewährleisten, einschließlich der Zu- und Abfahrt von Fahrzeugen.

○ Decorative Lighting

Dekorative Beleuchtung

(Encompassing wall, recessed, and landscape lights)

(umfasst Wand-, Einbau- und Landschaftsleuchten)

This uppermost layer adds aesthetic appeal, producing captivating visual effects while enhancing the overall look and feel of the outdoor area.

Diese oberste Ebene sorgt für eine ästhetische Ausstrahlung, die fesselnde visuelle Effekte erzeugt und das Gesamtbild des Außenbereichs aufwertet.



General Lighting
Zon IP Ceiling Lights and
Mill Landscape Pillars



Functional/Marker Lighting
Via Urbana Path Lighting



Decorative lighting
Rando Wall Lights

The Great Outdoors

Der große Außenbereich

An illuminated front and back garden, bathed in vibrant colours, gives a sense of warmth and security, creating the ideal ambiance to relax on your patio or decking in the evenings.

Outdoor lighting is an art form that delights the senses and is a practical necessity.

Ein in leuchtenden Farben getauchte Vorgarten oder vermittelt ein Gefühl von Wärme und Geborgenheit und schafft das ideale Ambiente, um sich abends auf der Terrasse oder der Veranda zu entspannen.

Außenbeleuchtung ist sowohl eine Kunst, die die Sinne verwöhnt, als auch eine praktische Notwendigkeit.

**Just as with interior lighting,
outdoor lighting is thoughtfully
designed with three distinct
layers →**

Ebenso wie die Innenbeleuchtung wird auch die Außenbeleuchtung sorgfältig
in drei verschiedenen Ebenen geplant →

General lighting

Allgemeine Beleuchtung

General lighting ensures orientation, comfort, and security within the outdoor space at night.

Die allgemeine Beleuchtung sorgt für Orientierung, Komfort und Sicherheit im nächtlichen Außenraum.

High-quality garden lighting is not only aesthetically pleasing but it's also vital for quality video surveillance.

Eine hochwertige Gartenbeleuchtung ist nicht nur ästhetisch ansprechend, sondern auch für eine gute Videoüberwachung unerlässlich.

The Outdoor Collection presents a wide array of outdoor lighting fixtures, spanning from classic to modern designs. Well chosen fixtures create an inviting outdoor space, enlarging the building's footprint and providing necessary security.

Die Outdoor-Kollektion bietet eine große Auswahl an Außenleuchten, von klassisch bis modern. Sorgfältig ausgewählte Leuchten schaffen einen einladenden Außenbereich, vergrößern die Grundfläche des Gebäudes und sorgen für die nötige Sicherheit.

For expansive areas, tall light poles delineate perimeters, principal structures, walkways, and entrances. In more compact settings, medium-sized poles such as **Elbe, Bonn, Mill, Wald, Hof**, and wall luminaires like **Rando, Shim and Lot** offer comprehensive illumination.

In weitläufigen Arealen markieren hohe Lichtmasten Grenzen, Hauptgebäude, Wege und Eingänge. In kompakteren Bereichen sorgen mittelgroße Masten wie Elbe, Bonn, Mill, Wald, Hof und Wandleuchten wie Rando, Shim und Lot für eine umfassende Beleuchtung.

Well-lit areas enable surveillance cameras to function effectively, acting as a deterrent for potential intruders. Even without surveillance, intruders are less likely to target illuminated areas compared to dark, concealed spaces.

Gut beleuchtete Bereiche ermöglichen eine effektive Arbeit der Überwachungskameras und schrecken potenzielle Eindringlinge ab. Auch ohne Überwachung ist die Wahrscheinlichkeit, dass Eindringlinge beleuchtete Bereiche angreifen, geringer als in dunklen, versteckten Räumen.



Mill Landscape Poles



Lot Wall Lights

Functional lighting

Funktionelle Beleuchtung

Functional lighting, often referred to as marker lighting, plays a pivotal role in maximising comfort and safety at night time. This form of lighting is especially pertinent for family gatherings and children's activities, ensuring a secure environment for active play.

A comprehensive selection of outdoor lighting fixtures, encompassing both light poles and recessed luminaires, means you can use your outdoor space at any time, in comfort and safety. Functional lighting strategically 'marks' pathways and areas whether for work or play.

Funktionelle Beleuchtung, oft auch als Orientierungsbeleuchtung bezeichnet, spielt eine entscheidende Rolle bei der Maximierung von Komfort und Sicherheit in der Nacht. Diese Art der Beleuchtung ist besonders wichtig für Familientreffen und Kinderaktivitäten, da sie eine sichere Umgebung für aktives Spielen gewährleistet.

Ein umfassendes Angebot an Außenbeleuchtungen, das sowohl Mastleuchten als auch Einbauleuchten umfasst, sorgt dafür, dass Sie Ihren Außenbereich jederzeit bequem und sicher nutzen können. Funktionale Beleuchtung „markiert“ strategisch Wege und Flächen, sei es zum Arbeiten oder zum Spielen.

Pendant and ceiling lights serve as indispensable elements for outdoor entertainment in gazebos or open verandas. In addition to their primary function, they facilitate visibility during evening twilight, cultivating a cosy and romantic atmosphere.

Pendel- und Deckenleuchten sind unentbehrliche Elemente für die Unterhaltung im Freien in Pavillons oder auf offenen Veranden. Neben ihrer Hauptfunktion erleichtern sie die Sicht in der Dämmerung und schaffen eine gemütliche und romantische Atmosphäre.

For illuminating the facades of houses, outhouses, garages, and entrances, our facade lighting range offers a variety of modern and classic Outdoor Maytoni wall lights

Für die Beleuchtung von Hausfassaden, Nebengebäuden, Garagen und Einfahrten bietet unser Fassadenbeleuchtungsprogramm eine große Auswahl an modernen und klassischen Maytoni Außenwandleuchten.

Medium and small light poles, alongside landscape luminaires with directional light (**Ares, Scope, Bern**) and recessed luminaires (**Biscotti, Limo, Bil**) are aptly suited for illuminating pathways and spaces.

Illuminating steps can be achieved with recessed luminaires such as **Mane, Bosca, Via Urbana, Bil, Lock, Biscotti, and Limo**.

To illuminate swimming pools, fountains, and other water features or areas likely to come into contact with water, we provide a wide array of luminaires boasting a high degree of moisture protection (IP65).

Für die Beleuchtung von Wegen und Plätzen eignen sich mittlere und kleine Lichtmasten sowie Landschaftsleuchten mit gerichtetem Licht (**Ares, Scope, Bern**) und Einbauleuchten (**Biscotti, Limo, Bil**).

Treppenstufen können mit Einbauleuchten wie **Mane, Bosca, Via Urbana, Bil, Lock, Biscotti** und **Limo** beleuchtet werden.

Für die Beleuchtung von Schwimmbädern, Springbrunnen und anderen Wasserspielen oder Bereichen, die mit Wasser in Berührung kommen können, bieten wir eine große Auswahl an Leuchten mit hohem Feuchtigkeitsschutz (IP65).

Our selection of outdoor pendants comprises both classic and contemporary luminaires: **Fleur, Erda, Salamanca**.

For entrance areas, garages, and outdoor work spaces we offer outdoor ceiling luminaires with understated elegance, such as **Roll, Bar, Willis, Ares, Spin, Zon IP**.



Hagen Landscape Poles



Bil Staircase Lighting



Erda Pendant Luminaires,
Fulton Wall Luminaires.

Decorative lighting

Dekorative Beleuchtung

Strategically placed decorative light fixtures emphasise the architectural forms of structures both large and small, enhancing the beauty of the landscaping, water features, plants, sculptures, and architectural elements.

Strategisch platzierte dekorative Beleuchtungskörper betonen die architektonischen Formen großer und kleiner Bauwerke und heben die Schönheit von Landschaftsgestaltungen, Wasserspielen, Pflanzen, Skulpturen und architektonischen Elementen hervor.

Decorative lighting serves as the perfect accent, drawing attention to specific features within the outdoor space while amplifying their aesthetic allure.

This style of lighting is often installed during the final design stage, adding a unique, personalised touch to the exterior, and delivering an unforgettable first impression.

Wall lights, such as **Strato**, **Wald**, **Times Square**, **Beekman**, and **Fulton**, are specifically designed for architectural lighting. With adjustable beam widths and angles, these luminaires provide endless possibilities for bringing even the most intricate concepts to life.

Dekorative Beleuchtung dient als perfekter Akzent, der die Aufmerksamkeit auf bestimmte Elemente im Außenbereich lenkt und gleichzeitig deren ästhetische Ausstrahlung verstärkt.

Diese Art der Beleuchtung wird oft in der letzten Phase der Planung installiert und verleiht dem Außenbereich eine einzigartige, persönliche Note, die einen unvergesslichen ersten Eindruck hinterlässt.

Wandleuchten wie Strato, Wald, Times Square, Beekman und Fulton wurden speziell für die Architekturbeleuchtung entwickelt. Mit ihren verstellbaren Ausstrahlungswinkeln und -breiten bieten diese Leuchten unendliche Möglichkeiten, selbst die kompliziertesten Konzepte zum Leben zu erwecken.



Strato Wall Lights

ARCHI- TECTORAL

Architectural lighting

LIGHTING

Maytoni Outdoor

Blow

GF

NEW

IP54

LED



EN Aluminum body, shade - graphite. Minimalistic, compact design. Glow in one or two directions. LED light source. Color temperature – 3000K. Ingress Protection Code – IP54.

DE Aluminiumrahmen, Farbe - Graphit. Minimalistisches kompaktes Design. Ein- und zweiseitiges Leuchten. LED-Lichtquelle. Farbtemperatur 3000K. Schutzgrad gegen Staub und Feuchtigkeit - IP 54.

IT Il corpo in alluminio, il colore è grafite. Design minimalista e compatto. Luminescenza in una e due direzioni. Sorgente luminosa a LED. La temperatura di colore è 3000K. Il grado di protezione da polvere e umidità è IP54.

FR Corps en aluminium, couleur - graphite. Conception minimaliste et compacte. Brille dans une ou deux directions. Source de lumière LED. Température de couleur 3000K. Degré de protection contre la poussière et l'humidité IP54.



1 ■



2 ■

1 ■ **O435WL-L10GF3K**

LED 10W 900lm
 t° 3000K >80Ra 122°
 IP 54

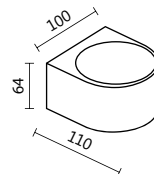
2 ■ **O435WL-L5GF3K**

LED 5W 500lm
 t° 3000K >80Ra 122°
 IP 54

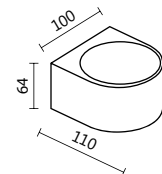



O435WL-L10GF3K

Pull

GF

NEW IP54 LED

EN Case material – aluminum, shade – graphite. Original diamond-like graphic shape. LED light source, color temperature - 3000K. Adjustable output lumen up and/or down. Architectural decorative lighting. Protection Code IP54.

DE Rahmenmaterial - Aluminium, Farbe - Graphit. Eigenartige grafische Rhombusform. LED-Lichtquelle, Farbtemperatur - 3000K. Einstellbarer Lichtstrom nach oben und/oder nach unten. Architektonische dekorative Beleuchtung. Schutzgrad - IP54.

IT Il materiale del corpo è alluminio, il colore è grafite. La forma grafica originale del rombo. Sorgente luminosa a LED, la temperatura di colore è 3000K. Il flusso luminoso regolabile su e / o giù. L'illuminazione decorativa di architettura. Il grado di protezione è IP54.

FR Matériau du corps - aluminium, couleur - graphite. Forme de losange graphique originale. Source de lumière LED, température de couleur 3000K. Rendement lumineux réglable vers le haut et/ou vers le bas. Éclairage d'intérieur architectural. Degré de protection - IP54.

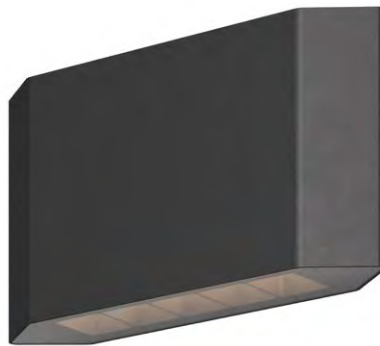

1,2

1 ■ **O412WL-L5GF3K**

LED 5W 450lm
t° 3000K >80Ra 35°
IP 54

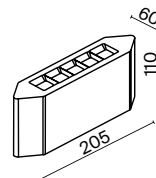
2 ■ **O412WL-L8GF3K**

LED 8W 650lm
t° 3000K >80Ra 35°
IP 54

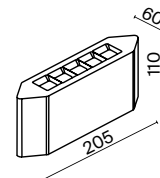

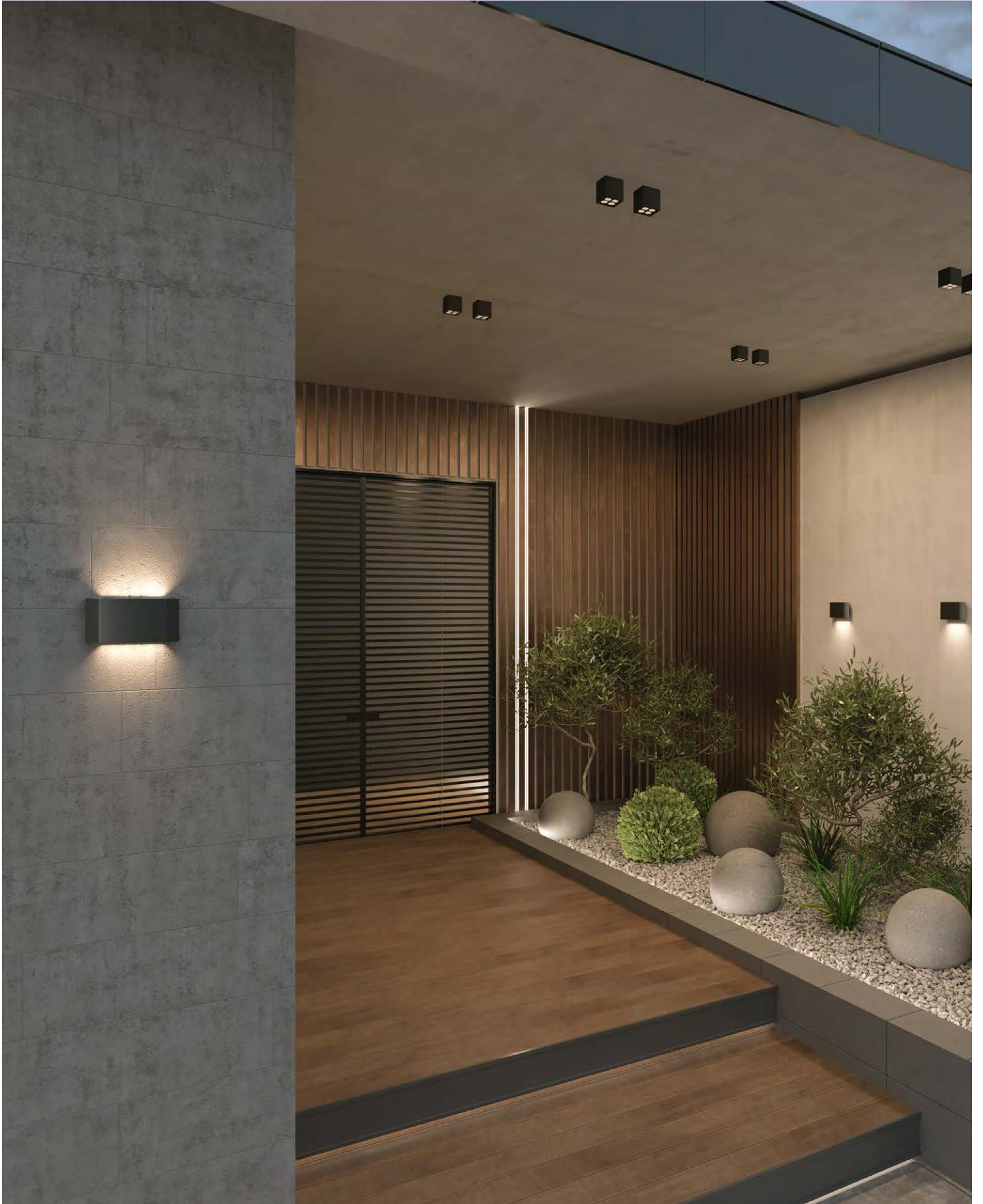

O412WL-L5GF3K

O412WL-L8GF3K

Show

GF W

NEW IP54 LED

EN Case material – aluminum, shade – graphite, white. Two beams of light from the upper and lower surface of the lamp. Ideal for making spectacular light drawings. LED source – IP54.

DE Rahmenmaterial - Aluminium, Farben - Graphit, Weiß. Zwei Lichtstrahlen von der Ober- und Unterseite der Leuchte. Ideal für Kompilieren von eindrucksvollen Lichtmustern. LED-Lichtquelle - IP54.

IT Il materiale del corpo è alluminio, i colori sono grafite, bianco. Due fasci di luce dalla superficie superiore e inferiore della lampada. Sono ideali per la realizzazione dei disegni luminosi impressionanti. Sorgente luminosa a LED, la temperatura di colore e' 3000K. Il grado di protezione e' IP54.

FR Matériau du corps - aluminium, couleurs - graphite, blanc. Deux faisceaux de lumière provenant des surfaces supérieure et inférieure de la lampe. Parfaits pour créer des motifs lumineux spectaculaires. Source lumineuse LED - IP54.

1 



2 



1  **O433WL-L4W3K**

LED 4W 200lm
t° 3000K >80Ra 64°
IP 54

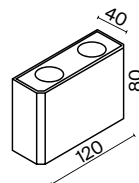

2  **O433WL-L4GF3K**

LED 4W 200lm
t° 3000K >80Ra 64°
IP 54

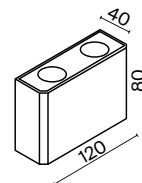



O433WL-L4W3K

Strato



EN Architectural Lighting. Body – metal, shades – black, grey, white. High level IP54. Protection against corrosion and temperature difference. LED source, color temperature is 3000K. Bidirectional light flux, models for 4 and 6 light beams. NEW IP54 LED.

DE Architektonische Bilderleuchten. Metallrahmen, Farbtöne: Schwarz, Grau, Weiß. Hoher Schutzgrad IP54. Schutz vor Korrosion und Temperaturschwankungen. LED-Lichtquelle mit einer Farbtemperatur von 3000K. Bidirektionaler Lichtstrom, Modelle mit 4 und 6 Lichtbündeln. NEW IP54 LED.

IT Illuminazione architettonica. Corpo - metallo, tonalità - nero, grigio, bianco. IP54 di alto livello. Protezione dalla corrosione e dagli sbalzi di temperatura. Sorgente LED, temperatura di colore 3000K. Flusso luminoso bidirezionale, modelli a 4 e 6 raggi. NEW IP54 LED.

FR Applique architecturale. Corps : métal, teintes : noir, gris, blanc. Haut niveau de protection : IP54. Protection contre la corrosion et les changements de températures. Source LED, température de couleur: 3000K. Flux lumineux bidirectionnel, modèles de 4 et 6 faisceaux lumineux. NEW IP54 LED.



1 ■ ■ ■ ■



2 ■ ■ ■ ■

- 1 ■ **O417WL-L4B3K**
 ■ **O417WL-L4GR3K**
 ■ **O417WL-L4W3K**

- 2 ■ **O417WL-L6B3K**
 ■ **O417WL-L6GR3K**
 ■ **O417WL-L6W3K**

LED 4W 400lm
 t° 3000K >80Ra 49°
 IP 54

LED 6W 600lm
 t° 3000K >80Ra 52°
 IP 54

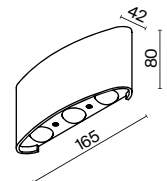
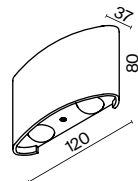

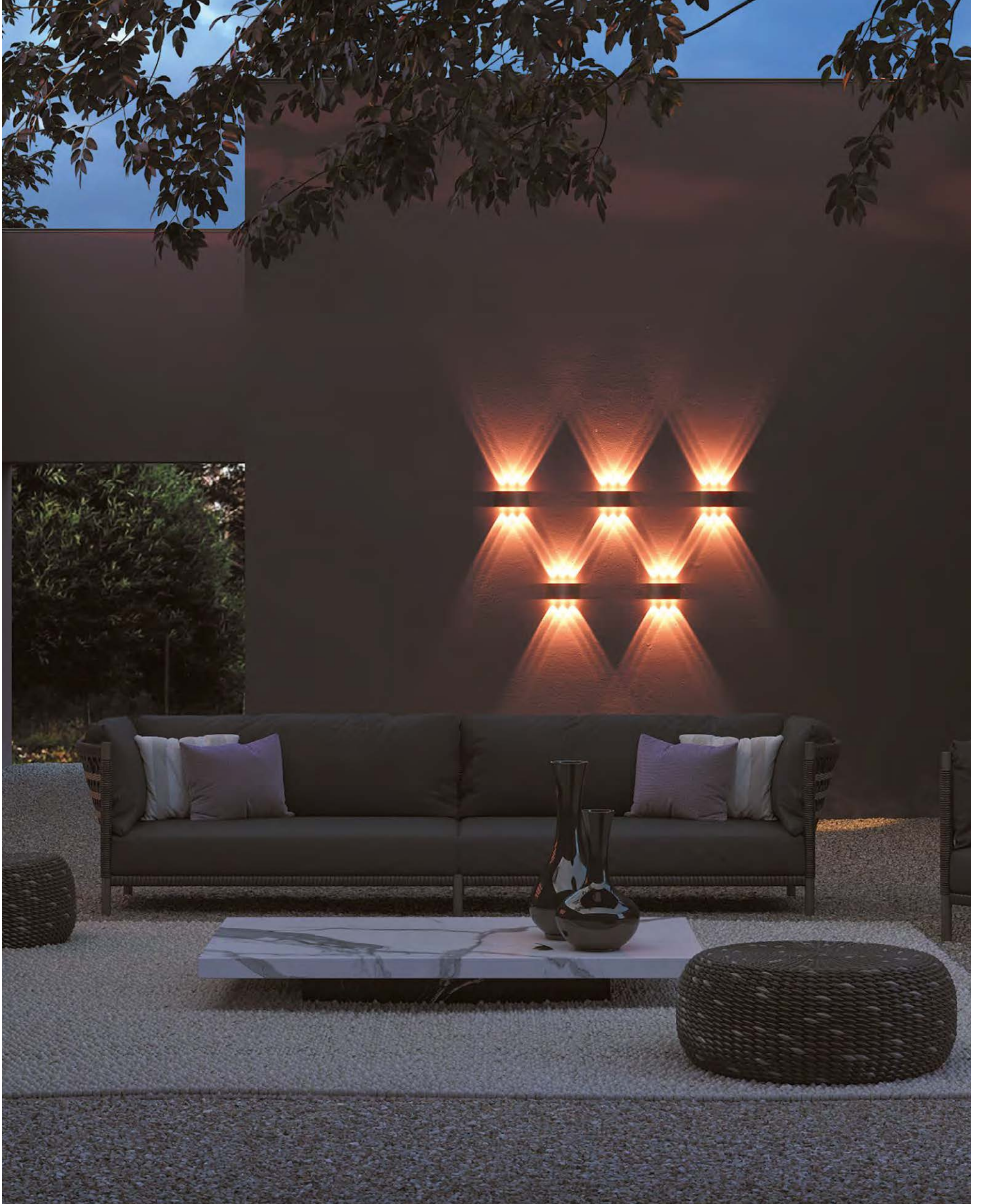

O417WL-L6B3K

Wald

GF

IP65 LED

EN Body material - metal, color - graphite. High level of protection against dust and moisture IP 65. Resistant to corrosion and temperature extremes. LED light source with a neutral color temperature of 3000K.

DE Rahmenmaterial: Metall, Farbton: Graphit. Hoher Schutzgrad gegen Staub und Feuchtigkeit: IP 65. Beständig gegen Korrosion und Temperaturschwankungen. LED-Lichtquelle mit einer neutralen Farbtemperatur von 3000K.

IT Materiale del corpo - metallo, colore - grafite. Alto livello di protezione contro polvere e umidità IP 65. Resistente alla corrosione e agli sbalzi di temperatura. Sorgente luminosa a LED con temperatura di colore neutra di 3000K.

FR Matériau du corps : métal, couleur : graphite. Haut niveau de protection contre la poussière et l'humidité IP 65. Résistance à la corrosion et aux variations de températures. Source de lumière LED avec une température de couleur neutre de 3000K.



1 ■



2 ■

1 ■ **O420WL-L12GF**

LED 12W 1050lm
 t° 3000K >80Ra 87°
 IP 65



2 ■ **O420WL-L7GF**

LED 7W 600lm
 t° 3000K >80Ra 87°
 IP 65



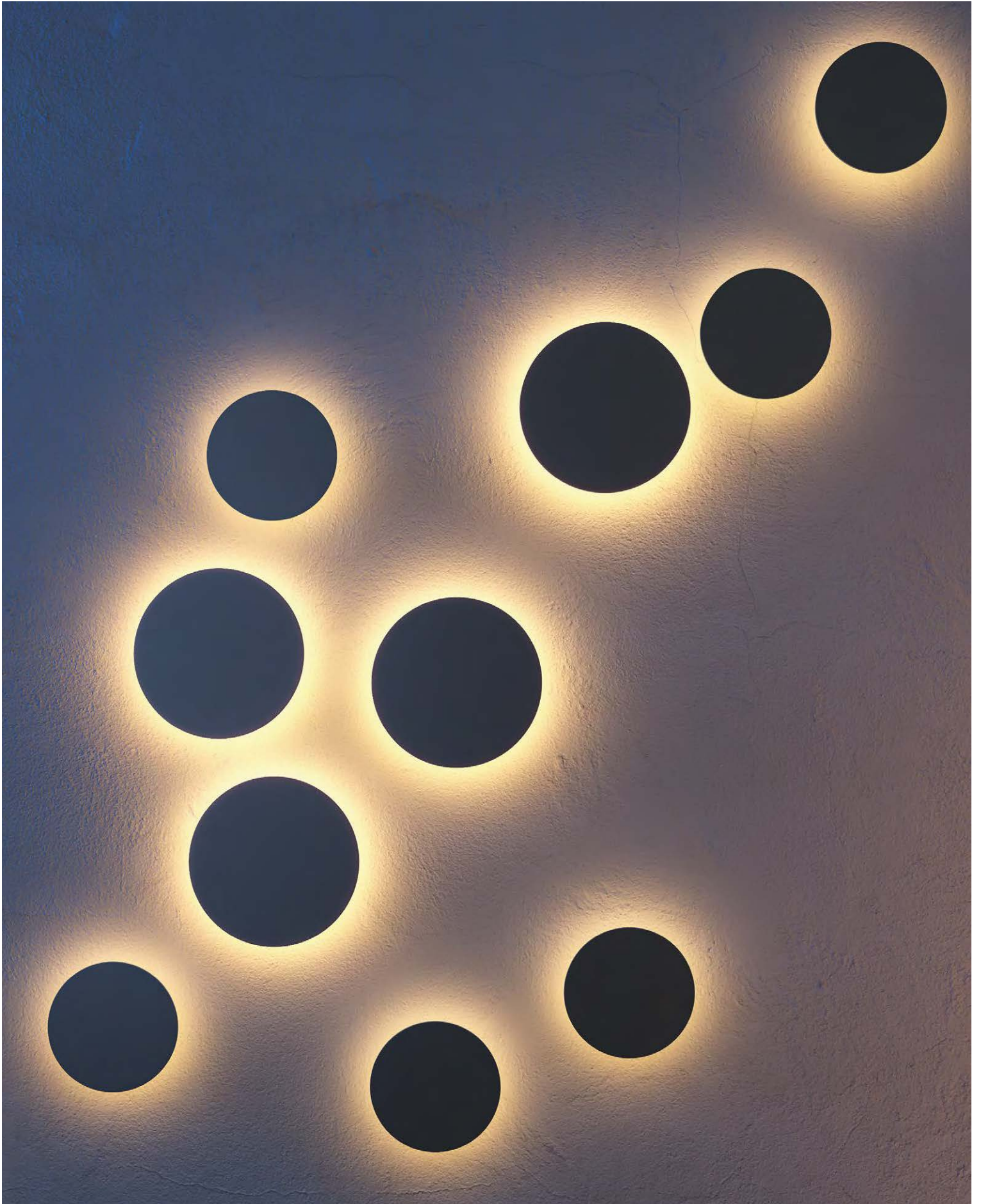

O420WL-L12GF

Times Square

B W

IP54 LED

EN Architectural lighting. Metal body in three colors: white and black. High level IP54, protection against corrosion and temperature extremes. Bidirectional light flux.

DE Architektonische Bilderleuchten. Metallrahmen in drei Farbtönen: Weiß und Schwarz. Hohe Schutzart IP54, Schutz gegen Korrosion und Temperaturschwankungen. Bidirektionaler Lichtstrom.

IT Illuminazione architettonica. Corpo metallico in tre tonalità: bianco e nero. Alto livello IP54, protezione dalla corrosione e dagli sbalzi di temperatura. Flusso luminoso bidirezionale.

FR Éclairage architectural. Corps métallique en trois teintes : blanc et noir. Haut niveau de protection IP54, protection contre la corrosion et les variations de températures. Flux lumineux bidirectionnel.

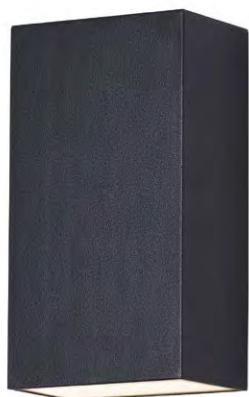

1 ■



2 ■ □

1 ■ **O581WL-L6B**

LED 6 W 480lm
 t° 3000K >80Ra 90°
 IP 54

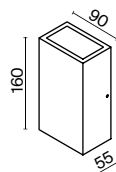

2 ■ **O580WL-L6B**
 □ **O580WL-L6W**

LED 6 W 100lm
 t° 3200K >80Ra 120°
 IP 54



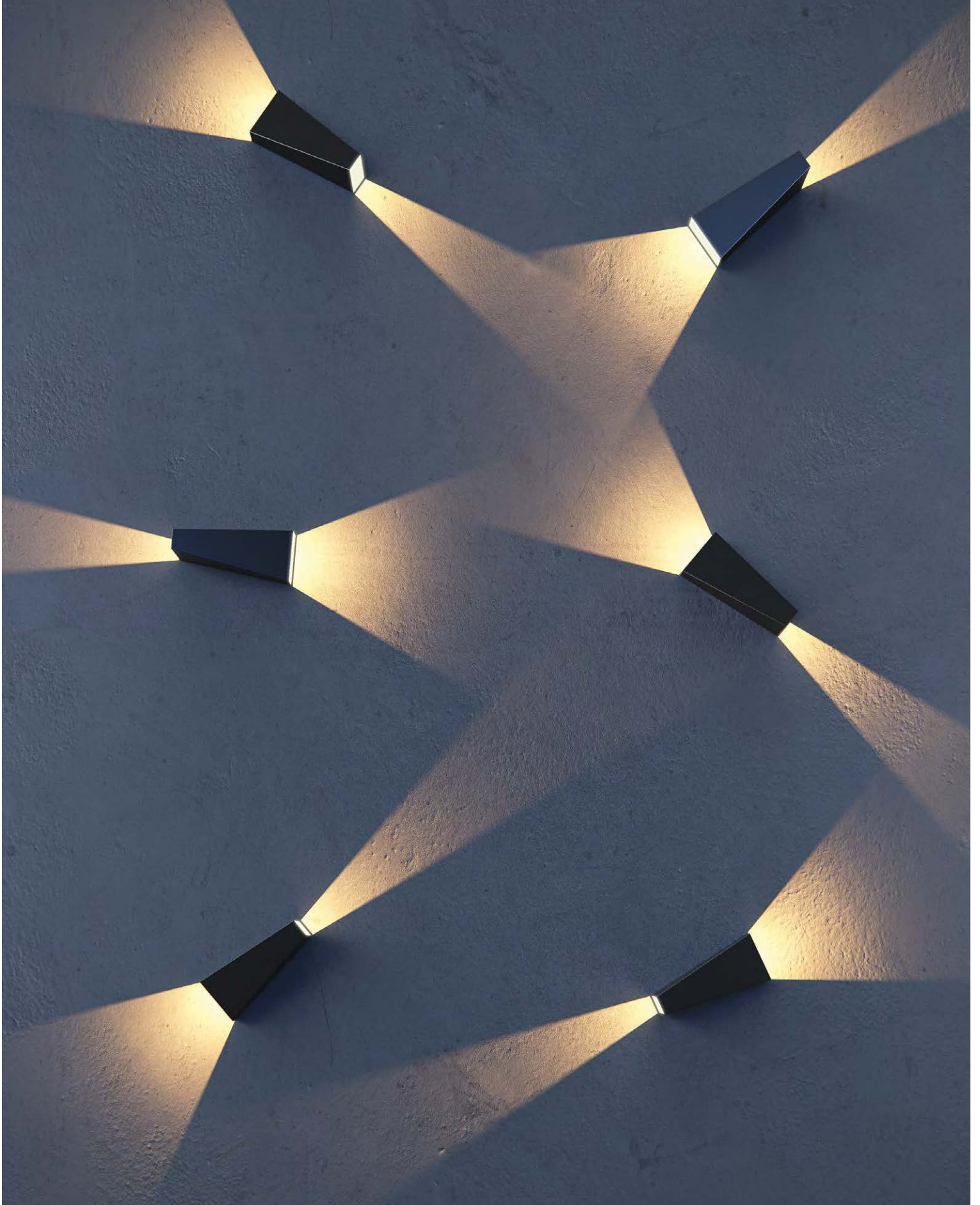

O580WL-L6B

Beekman

B

EN Metal body in black color. LED light source with driver. Color temperature 3000K. High level IP54. The model is equipped with silicone gaskets and protective glass.

DE Metallrahmen in Schwarz. LED-Lichtquelle mit Drive. Farbtemperatur 3000K. Hohe Schutzart IP54. Ausgestattet mit Silikondichtungen und Schutzglas.

IT Corpo in metallo nero. Sorgente luminosa a LED con driver. Temperatura colore 3000K. Alto livello di IP54. Il modello è dotato di guarnizioni in silicone e vetro di protezione.

FR Corps métallique de couleur noire. Source de lumière LED avec driver. Température de couleur 3000K. Haut niveau IP54. Le modèle est équipé de joints en silicone et d'un verre de protection.



1 ■

1 ■ **O577WL-L5B**

LED 6W 540lm
t° 3000K >80Ra 120°
IP 54

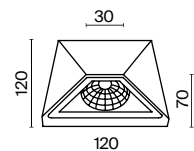

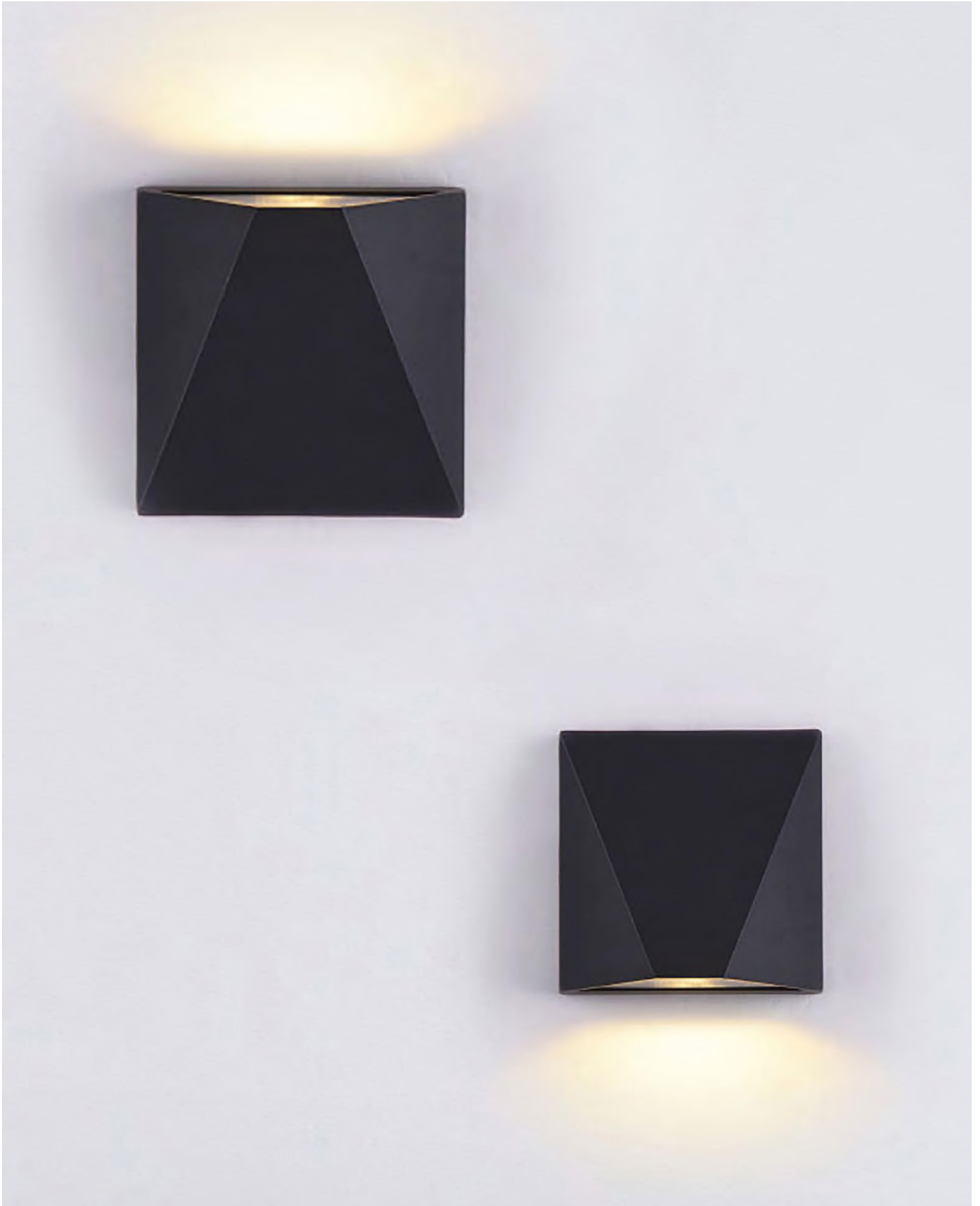

O577WL-L5B

Fulton



EN Metal body, powder coating in white and black color. LED module. Corrosion resistance. High level IP54. Movable shutters for adjusting the angle of the light flux.

DE Metallrahmen, pulverbeschichtet in Weiß und Schwarz. LED-Modul. Korrosionsbeständig. Hoher Schutzgrad IP54. Bewegliche Vorhänge zum Einstellen des Winkels des Lichtstroms.

IT Corpo in metallo, verniciato a polvere in bianco e nero. Modulo LED. Resistenza alla corrosione. IP54 di alto livello. Tende scorrevoli per la regolazione dell'angolo del flusso luminoso.

FR Corps métallique, revêtement par poudre de couleur blanche et noire. Module LED. Résistance à la corrosion. Haut niveau de protection : IP54. Volets mobiles pour le réglage de l'angle du flux lumineux.



1



2

1 **O572WL-L6B**
 O572WL-L6W

LED 6W 400lm
t° 3000K >80Ra 64°
IP 54

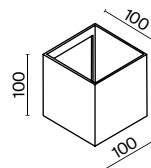

2 **O573WL-L6B**
 O573WL-L6W

LED 6W 400lm
t° 3000K >80Ra 90°
IP 54

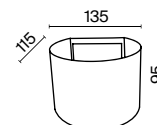



MODERN

LIGHTING

Maytoni Outdoor

Mon

GF

NEW

IP65

LED



EN Aluminium fittings, color: graphite. Double diffuser. Internal: white matte acryl, upper: transparent plastic. LED light source, color temperature: 3000K. Protection rating: IP54. Suitable for outdoor and indoor use.

DE Aluminiumgehäuse, graphitfarben. Doppelter Diffusor. Der innere Diffusor aus dem weiß-matten Acryl, der obere Diffusor aus dem transparentem Kunststoff. LED-Lichtquelle, Farbtemperatur - 3000K. Schutzart IP54. Sowohl für den Außen- als auch für den Innenbereich geeignet.

IT Il materiale del corpo è in alluminio, il colore è grafite. Il diffusore doppio. L'interno diffusore è fatto in acrilico bianco opaco, quello di superiore è fatto in plastica trasparente. La sorgente luminosa a LED, la temperatura di colore e' 3000K. Il grado di protezione e' IP54. Adatto sia per l'uso esterno che interno.

FR Matériau du corps - aluminium, couleur - graphite. Double diffuseur. Intérieur - acrylique blanc mat, supérieur - plastique transparent. Source de lumière LED, température de couleur - 3000K. Degré de protection IP54. Convient à une utilisation extérieure et intérieure.



1 ■

1 ■ **O438CL-L12GF3K**

LED 12W 1100lm
 t° 3000K >80Ra 152°
 IP 65

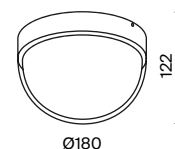



O438CL-L12GF3K

Badd

GF

IP54 LED

EN Case material – aluminum, shade – graphite. Diffuser is made of white matte acrylic. Two diffuser models: square and rounded. LED light source. Color temperature – 3000K. Ingress Protection Code – IP54.

DE Rahmenmaterial - Aluminium, Farbe - Graphit. Diffusor aus weißem mattem Acryl. Zwei Diffusorformen - quadratisch und abgerundet. LED-Lichtquelle. Farbtemperatur 3000K. Schutzgrad gegen Staub und Feuchtigkeit - IP54.

IT Il materiale del corpo è alluminio, il colore è grafite. Il diffusore in acrilico bianco opaco. Le due forme del diffusore sono quadrate e arrotondate. Sorgente luminosa a LED. La temperatura di colore è 3000K. Il grado di protezione da polvere e umidità è IP54.

FR Matériau du corps - aluminium, couleur - graphite. Diffuseur en acrylique blanc mat. Deux formes de diffuseur - carré et arrondi. Source de lumière LED. Température de couleur 3000K. Degré de protection contre la poussière et l'humidité - IP54.



1



2

1 ■ **O454WL-L10GF3K**

LED 10W 700lm
 t° 3000K >80Ra 148°
 IP 54

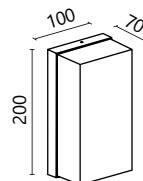
2 ■ **O454WL-L10GF3K1**

LED 10W 700lm
 t° 3000K >80Ra 155°
 IP 54

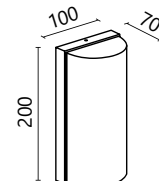



O454WL-L10GF3K

Bar

GF

IP65

LED



EN Metal body in trendy graphite shade. Resistant to corrosion and temperature differences. High level IP65. Compact dimensions. LED module, color temperature is 3000K. The series includes ceiling lamps of various diameters and power.

DE Metallrahmen in einem trendigen Farbton Graphit. Beständig gegen Korrosion und Temperaturschwankungen. Hoher Schutzgrad IP65. Kompakte Abmessungen. LED-Modul mit einer Farbtemperatur von 3000K. Die Serie wird durch Deckenleuchten unterschiedlicher Durchmesser und Leistung dargestellt.

IT Corpo in metallo color grafite alla moda. Resistente alla corrosione e agli sbalzi di temperatura. IP65 di alto livello. Dimensioni compatte. Modulo LED, temperatura di colore 3000K. La serie è rappresentata da lampade da soffitto di vari diametri e potenze.

FR Corps métallique dans une teinte graphite tendance. Résistance à la corrosion et aux changements de températures. Haut niveau de protection IP65. Module LED, température de couleur : 3000K. La série propose des plafonniers de différents diamètres et puissances.



1



2

1 ■ **O306CL-L12GF**

LED 12W 1300lm
 t° 3000K >80Ra 81°
 IP 65

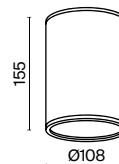
2 ■ **O306CL-L7GF**

LED 7W 800lm
 t° 3000K >80Ra 81°
 IP 65

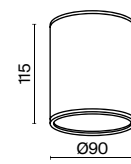



O306CL-L7GF

Barrel

GF



EN Metallic body, shade - graphite. Transparent glass lampshade protected by a decorative metal grid. Light source – lamp with an E27 base. Ingress Protection Code – IP54.

DE Metallrahmen, Farbe - Graphit. Lampenschirm aus transparentem Glas ist durch ein dekoratives Metallgitter geschützt. Lichtquelle - Leuchtmittel mit E27-Fassung. Schutzgrad gegen Staub und Feuchtigkeit - IP54.

IT Il corpo in metallo, il colore è grafite. Il paralume in vetro trasparente è protetto da una griglia metallica decorativa. La sorgente dell'illuminazione è una lampadina con un portalampada E27. Il grado di protezione da polvere e umidità è IP54.

FR Corps en métal, couleur - graphite. L'abat-jour en verre transparent est protégé par une grille métallique décorative. Source de lumière - lampe avec culot E27. Degré de protection contre la poussière et l'humidité - IP54.

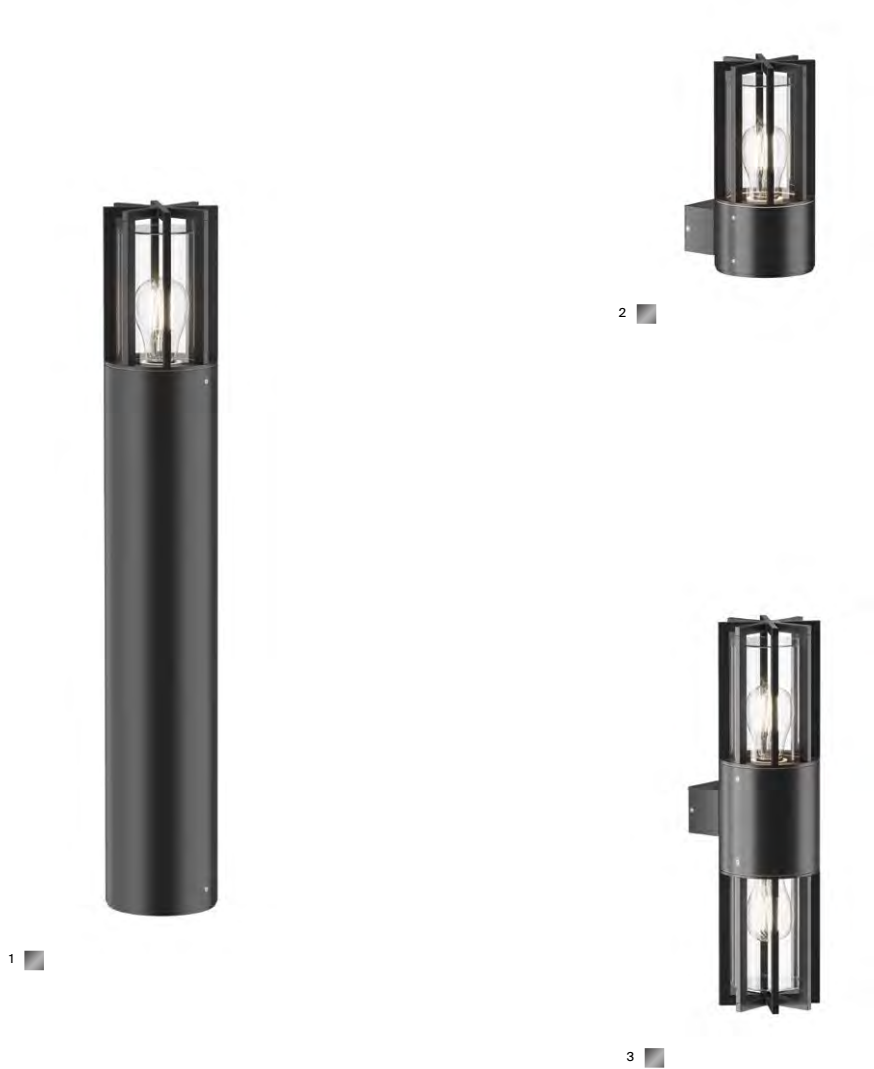

1 ■ **O453FL-01GF**

💡 1 × E27 15 W
IP 54

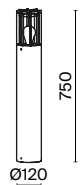

2 ■ **O453WL-01GF**

💡 1 × E27 15 W
IP 54

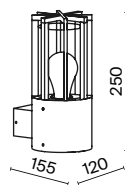

3 ■ **O453WL-02GF**

💡 2 × E27 15 W
IP 54

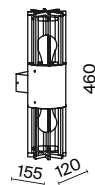



O453FL-01GF

Bern

GF W

NEW LED LED

EN Aluminium body. Corrosion protected. Glass diffuser. Shades: white, graphite. LED light source, color temperature: 3000K. Several power levels to choose. Color rendering index: 80Ra. High degree of protection against dust and moisture: IP65.

DE Aluminiumgehäuse. Korrosionsschutz. Diffusor aus Glas. Farbtöne: weiß, Graphit. LED-Lichtquelle, Farbtemperatur - 3000K. Mehrere Leistungsstufen zur Auswahl. Farbwiedergabeindex: 80Ra. Hoher Schutzart vor Staub und Feuchtigkeit: IP65.

IT Un corpo in alluminio. La protezione dalla corrosione. Il diffusore e' fatto in vetro. Le tonalita' sono bianco, grafite. La sorgente luminosa a LED, la temperatura di colore e' 3000K. I diversi gradi di potenza tra cui si puo' scegliere. L'indice di resa cromatica e' 80Ra. L'alto grado di protezione dalla polvere e l'umidità e' IP65.

FR Corps en aluminium. Protégé contre la corrosion. Diffuseur en verre. Abat-jour - blanc, graphite. Source de lumière LED, température de couleur - 3000K. Plusieurs niveaux de puissance au choix. Indice de rendu des couleurs - 80Ra. Haut degré de protection lapoussière et de l'humidité - IP65.



1 ■ **O050FL-L5GF3K**
□ **O050FL-L5W3K**

LED 5W 280lm
t° 3000K >80Ra 65°
IP 65

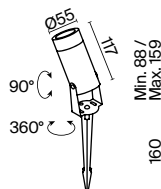

2 ■ **O050FL-L15GF3K**
□ **O050FL-L15W3K**

LED 15W 1200lm
t° 3000K >80Ra 55°
IP 65

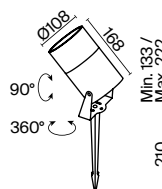

3 ■ **O050FL-L30GF3K**
□ **O050FL-L30W3K**

LED 30W 2800lm
t° 3000K >80Ra 50°
IP 65

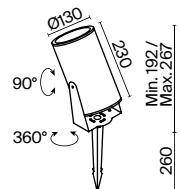



Bonn

GF



EN Body material – metal, shade – graphite. Protection against corrosion and temperature differences. High level IP65. Light source – LED module with neutral color temperature of 3000K. Trendy rectangular arch shape. The series includes outdoor lamps of various heights and power.

DE Rahmenmaterial: Metall, Farbton: Graphit. Schutz vor Korrosion und Temperaturschwankungen. Hoher Schutzgrad IP65. Lichtquelle: LED-Modul mit einer neutralen Farbtemperatur von 3000K. Trendige Form eines rechteckigen Bogens. Die Serie umfasst Außenleuchten unterschiedlicher Höhe und Leistung.

IT Materiale della corpo – metallo, tonalità – grafite. Protezione dalla corrosione e dagli sbalzi di temperatura. IP65 di alto livello. La sorgente luminosa è un modulo LED con temperatura di colore neutra di 3000K. Forma da arco rettangolare alla moda. La serie comprende lampioni di varie altezze e potenze.

FR Matériau du corps : métal, teinte : graphite. Protection contre la corrosion et les changements de températures. Haut niveau de protection IP65. Source de lumière : module LED avec une température de couleur neutre de 3000K. Forme d'arc rectangulaire tendance. La série comprend des lampadaires extérieurs de différentes hauteurs et puissances.



1 ■ **O425FL-L25GF**

LED 25 W 1350lm
t° 3000K >80Ra 150°
IP 65

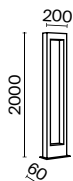

2 ■ **O425FL-L20GF**

LED 20 W 1000lm
t° 3000K >80Ra 150°
IP 65



3 ■ **O425FL-L10GF**

LED 10 W 550lm
t° 3000K >80Ra 150°
IP 65

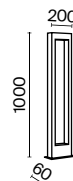



O425FL-L25GF

Brick

GF

NEW IP54 LED

EN Case material – aluminum, shade – graphite. Can be placed both horizontally and vertically. LED light source, color temperature - 3000K. Suitable for the organization of main lighting, walk-through areas and commercial spaces. Ingress Protection Code – IP54.

DE Rahmenmaterial - Aluminium, Farbe - Graphit. Möglichkeit der horizontalen und vertikalen Aufstellung. LED-Hochleistungslichtquelle, Farbtemperatur - 3000K Geeignet für Grundbeleuchtung, Durchgänge und Plätze. Schutzgrad gegen Staub und Feuchtigkeit - IP54.

IT Il materiale del corpo è alluminio, il colore è grafite. Possibilità di posizionamento sia orizzontale che verticale. Potente fonte luminosa a LED, la temperatura di colore-e' 3000K. Adatte per l'organizzazione dell'illuminazione principale, aree di passaggio e siti. Il grado di protezione da polvere e umidità è IP54.

FR Matériau du corps - aluminium, couleur - graphite. Possibilité de placement horizontal et vertical. Source de lumière LED puissante, température de couleur - 3000K. Convient à organiser l'éclairage principal, les zones de passage et les aires. Le degré de protection contre la poussière et l'humidité est IP54.



1 ■ **O436WL-L10GF3K**

LED 10W 1100lm
t° 3000K >80Ra 109°
IP 54

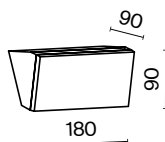

2 ■ **O436WL-L10GF3K1**

LED 10W 1100lm
t° 3000K >80Ra 109°
IP 54

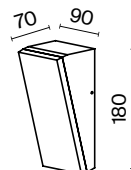

3 ■ **O436WL-L20GF3K**

LED 20W 1600lm
t° 3000K >80Ra 105°
IP 54

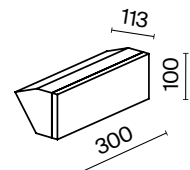

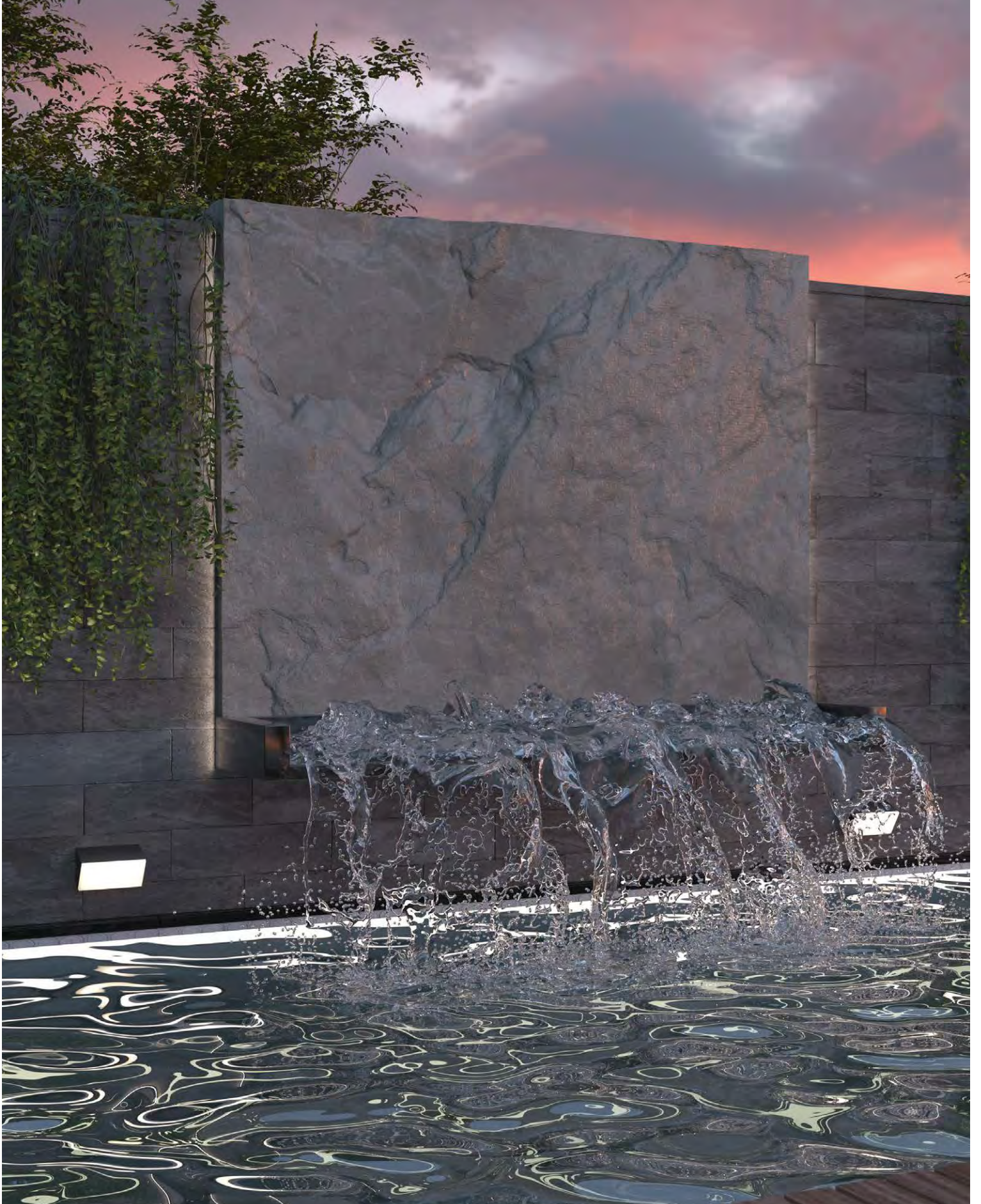

O436WL-L10GF3K

Candle

GF

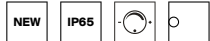

EN Case material – aluminum, shade – graphite. With or without decorative metal grid. Ideal for lighting entrance areas. Loft style. Light source – lamp with an E27 base. Protection Code – IP65.

DE Rahmenmaterial - Aluminium, Farbe - Graphit. Mit oder ohne dekoratives Metallgitter. Ideal für die Beleuchtung von Eingängen. Loft-Stil. Lichtquelle - Leuchtmittel mit E27-Fassung. Hoher Schutzgrad - IP65.

IT Il materiale del corpo è alluminio, il colore è grafite. Con e senza griglia metallica decorativa. Ideale per l'illuminazione le aree di ingresso. Stile e' loft. La sorgente dell'illuminazione è una lampadina con un porta-lampada E27. L'alto grado di protezione e' IP65.

FR Matériau du corps - aluminium, couleur - graphite. Avec ou sans grille métallique décorative. Parfaits pour éclairer les zones d'entrée. Style loft. Source de lumière - lampe avec culot - E27. Haut degré de protection - IP65.



1 ■



2 ■

1 ■ **O449WL-01GF**

1 × E27 15 W
IP 65

2 ■ **O449WL-01GF1**

1 × E27 15 W
IP 65

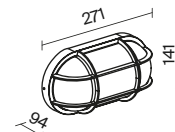
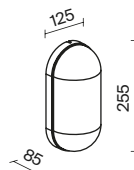



Amas

GF

NEW IP54

EN Aluminum body, shade - graphite. Light element – tinted glass. Light source – lamp with an E27 base. Versatile series for both modern and classic exteriors. IP54 protection.

DE Aluminiumrahmen, Farbe - Graphit. Leuchtelement - getöntes Glas. Lichtquelle - Leuchtmittel mit E27-Fassung. Die universelle Serie für moderne und klassische Außeneinrichtungen. Schutzgrad IP54.

IT Corpo in alluminio, il colore è grafite. L'elemento luminoso è il vetro colorato. La sorgente dell'illuminazione è una lampadina con un portalampada E27. Serie versatile per esterni moderni e classici. Il grado di protezione è IP54.

FR Corps en aluminium, couleur - graphite. L'élément lumineux - verre fumé. Source lumineuse - lampe avec douille E27. Série universelle pour extérieurs modernes et classiques. Protection IP54.



1 ■ **O432WL-02GF**

⚡ 2 x E27 60 W
IP 54

2 ■ **O432WL-01GF**

⚡ 1 x E27 60 W
IP 54

3 ■ **O432FL-01GF**

⚡ 1 x E27 60 W
IP 54

4 ■ **O432FL-01GF1**

⚡ 1 x E27 60 W
IP 54

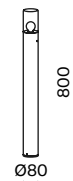
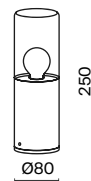
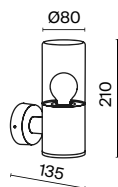
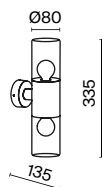



O432WL-01GF

O432FL-01GF1

Cell

GF

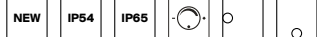

EN Case material – aluminum, shade – graphite. Diffuser material – PC plastic. Light source – lamp with an E27 base. Models available with a built-in motion sensor. Protection Code IP54.

DE Rahmenmaterial - Aluminium, Farbe - Graphit. Material des Diffusors - PC-Kunststoff. Lichtquelle - Leuchtmittel mit E27-Fassung. Verfügbarkeit von Modellen mit eingebautem Bewegungssensor. Schutzgrad - IP54.

IT Il materiale del corpo è alluminio, il colore è grafite. Il materiale del diffusore è termoplastica. La sorgente dell'illuminazione è una lampadina con un portalampada E27. Disponibilità di modelli con sensore di movimento integrato. Il grado di protezione è IP54.

FR Matériau du boîtier - aluminium, couleur - graphite. Matériau du diffuseur : plastique PC. Source de lumière - lampe avec culot E27. Disponibilité de modèles avec capteur de mouvement intégré. Degré de protection - IP54.



1



2



3

1 ■ **O452WL-01GF1**

💡 1 x E27 15 W
IP 65

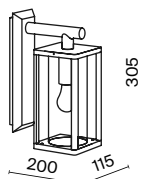

2 ■ **O452WL-01GFSR**

💡 1 x E27 15 W
IP 65

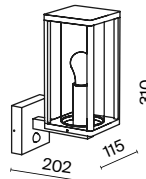

3 ■ **O452WL-01GF**

💡 1 x E27 15 W
IP 65

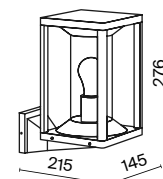



4 ■



5 ■

4 ■ **O452FL-01GF2**

💡 1 × E27 15 W
IP 54

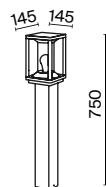

5 ■ **O452FL-01GF3**

💡 1 × E27 15 W
IP 54

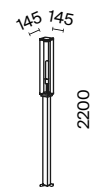

Cell



6 ■



7 ■

6 ■ **O452FL-01GF**

💡 1 × E27 15 W
IP 54

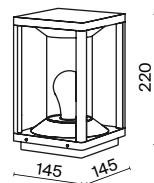

7 ■ **O452FL-01GF1**

💡 1 × E27 15 W
IP 54

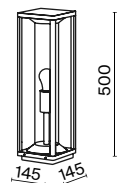

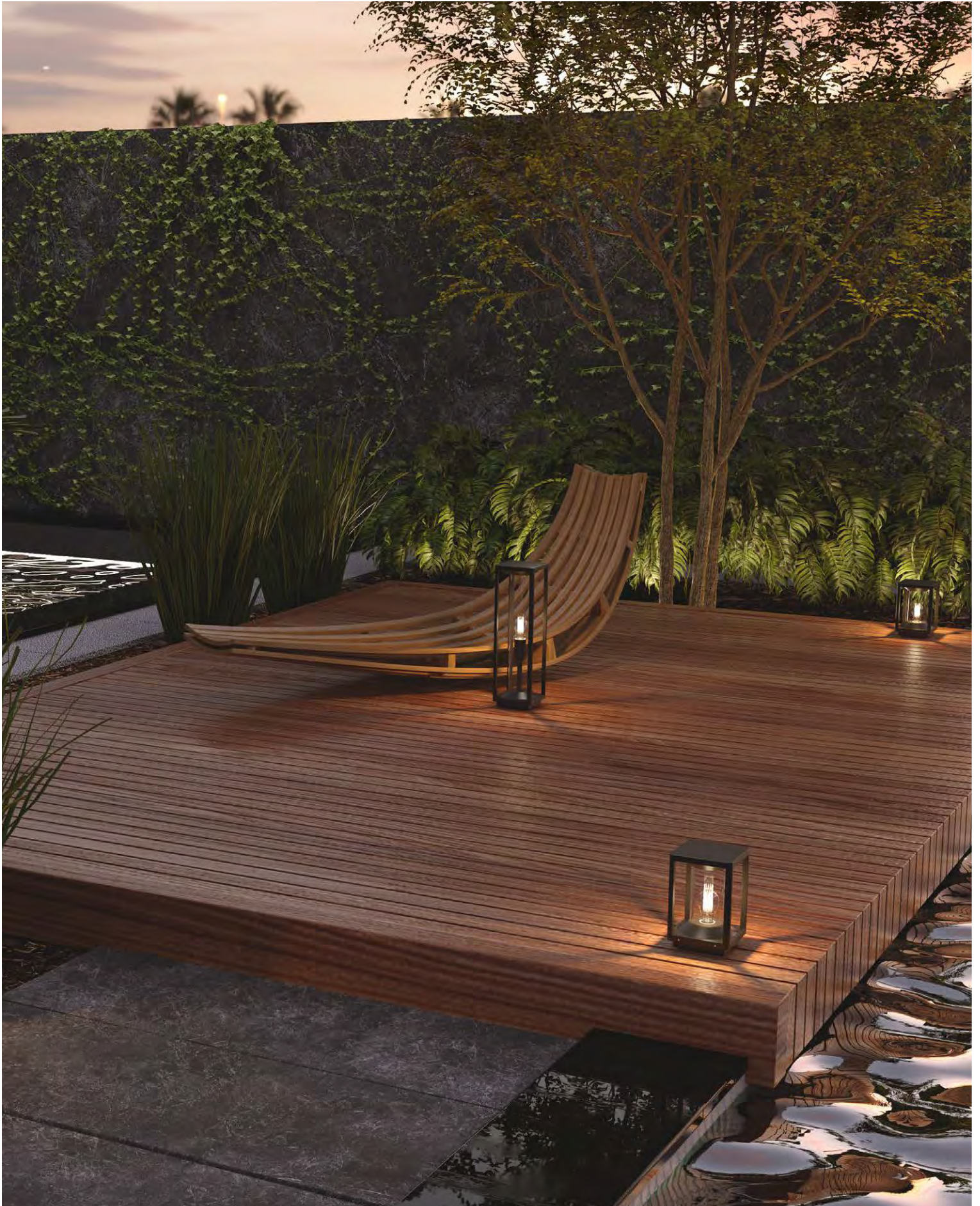

O452FL-I01GF

O452FL-L01GF1

Conf

GF

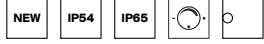

EN Aluminum body, shade - graphite. The diffuser is made of durable tinted plastic in 2 shapes: square and rounded. Ideal for loft-style exteriors and lighting of entrance areas. Light source – lamp with an E27 base. Protection Code IP54.

DE Aluminiumrahmen, Farbe - Graphit. Diffusor aus strapazierfähigem getöntem Kunststoff in 2 Formen: quadratisch und abgerundet. Ideal für Außeneinrichtungen im Loft-Stil und die Beleuchtung von Eingängen. Lichtquelle - Leuchtmittel mit E27-Fassung. Schutzgrad - IP54.

IT Corpo in alluminio, il colore è grafite. Diffusore in plastica resistente e colorata in 2 forme: quadrata e arrotondata. Ideale per esterni in stile loft e dell'illuminazione delle aree d'ingresso. La fonte dell'illuminazione è una lampadina con un portalampada E27. Il grado di protezione-e' IP54.

FR Corps en aluminium, couleur - graphite. Le diffuseur est en plastique fumé durable en 2 formes : carré et arrondi. Parfaits pour les extérieurs de style loft et l'éclairage des entrées. Source de lumière - lampe avec culot E27. Degré de protection - IP54.



1 ■



2 ■

1 ■ **O450WL-01GF**

💡 1 x E27 15 W
IP 65

2 ■ **O451WL-01GF**

💡 1 x E27 15 W
IP 54

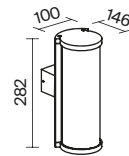
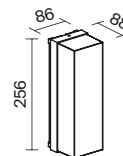



Edge

GR B

IP65 LED

EN Series of luminaries for landscape lighting. Body – aluminum, shades – black and grey. High level IP65, resistant to corrosion and temperature differences. Swivel diffuser.

DE Eine Serie von Leuchten für die Landschaftsbeleuchtung. Aluminiumrahmen, Farbtöne: Schwarz und Grau. Hoher Schutzgrad IP65, Beständigkeit gegen Korrosion und Temperaturschwankungen. Drehbarer Diffusor.

IT Una serie di lampade per l'illuminazione da esterno. Corpo: alluminio, tonalità – nero e grigio. Alto livello IP65, resistenza alla corrosione e agli sbalzi di temperatura. Diffusore girevole.

FR Série de luminaires pour l'éclairage paysager. Corps: aluminium, teintes: noir et gris. Haut niveau de protection IP65, résistance à la corrosion et aux changements de températures. Diffuseur pivotant.



1 ■ ■

1 ■ **O415FL-L15B3K**
■ **O415FL-L15GR3K**

LED 15 W 1000lm
t° 3000K >80 Ra 110°
IP 65

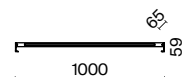

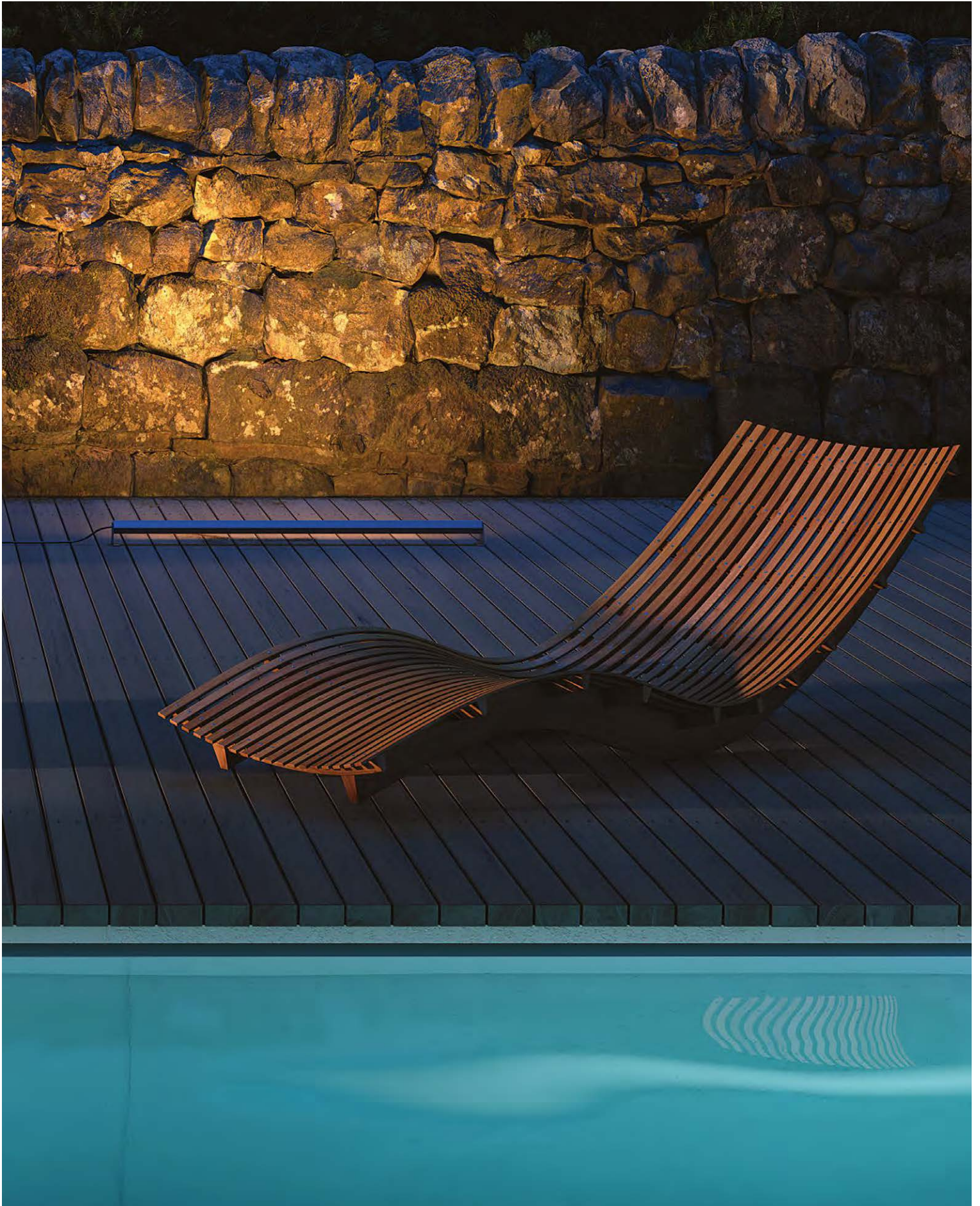

O415FL-L15B3K

Elbe

GF

IP65 LED

EN Series of outdoor lamps of various height. Metal body, color – graphite. High protection class IP65, protection against corrosion and temperature differences. LED light source, color temperature is 3000K. Strict geometry in design.

DE Eine Serie von Außenleuchten unterschiedlicher Höhe. Metallrahmen, Farbton: Graphit. Hoher Schutzgrad IP65, Schutz vor Korrosion und Temperaturschwankungen LED-Lichtquelle mit einer Farbtemperatur von 3000K. Strenge Geometrie im Design.

IT Serie di lampioni di varie altezze. Corpo in metallo, colore - grafite. Elevato grado di protezione IP65, protezione dalla corrosione e dagli sbalzi di temperatura. Sorgente luminosa a LED, temperatura di colore 3000K. Geometria rigorosa nel design.

FR Série de lampadaires extérieurs de diverses hauteurs. Corps métallique, couleur : graphite. Haute classe de protection IP65. Protection contre la corrosion et les changements de températures. Source de lumière LED, température de couleur 3000K. Design strictement géométrique.

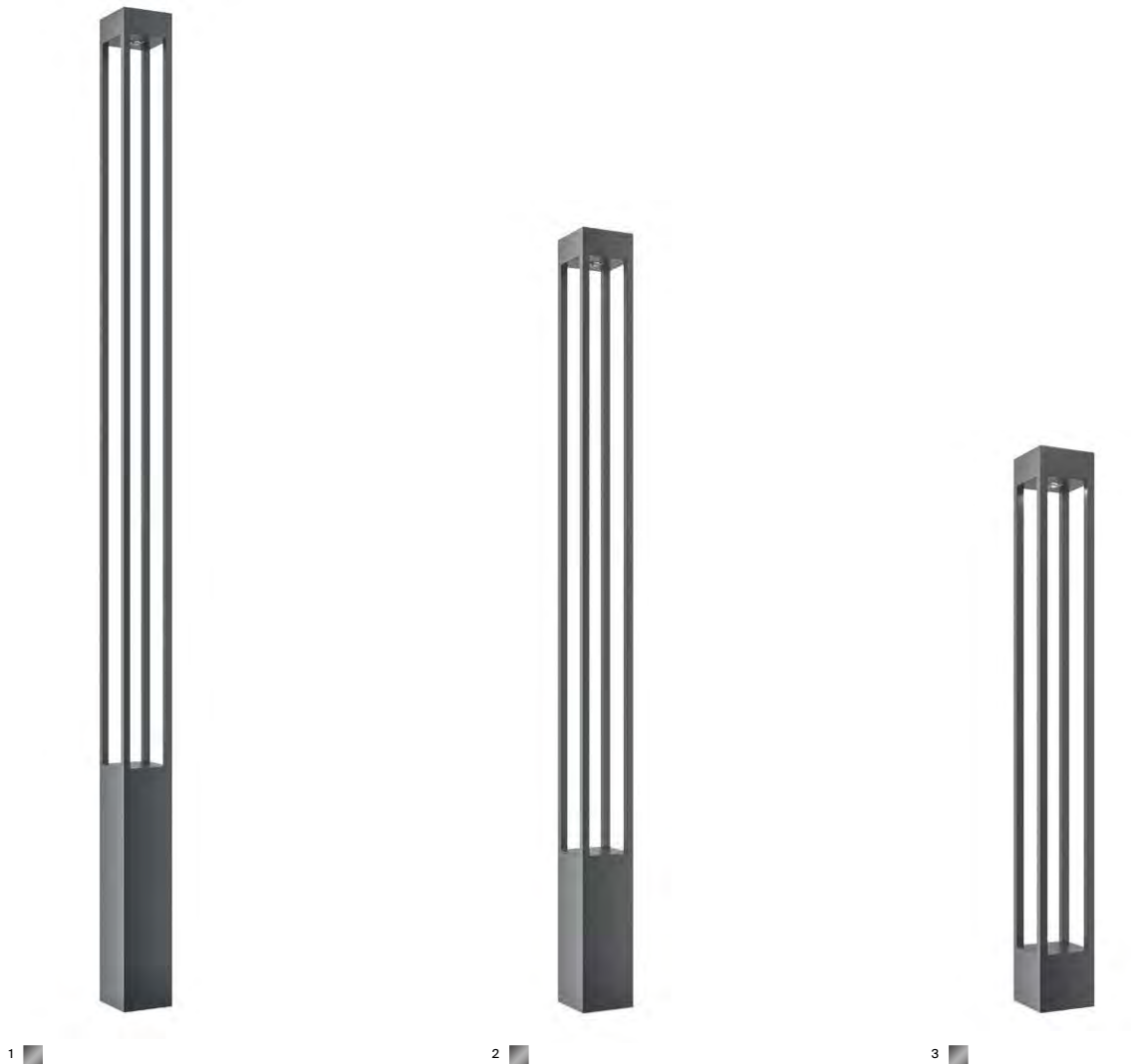

1 ■ **O424FL-L25GF**

LED 25 W 1500lm
t° 3000K >80Ra 36°
IP 65



2 ■ **O424FL-L20GF**

LED 20 W 1100lm
t° 3000K >80Ra 36°
IP 65



3 ■ **O424FL-L10GF**

LED 10 W 650lm
t° 3000K >80Ra 36°
IP 65





O424FL-L20GF

Erda

W

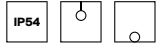

EN Series of landscape lamps. Body material – plastic, color – white. High level of protection against dust and moisture IP54. Light source – lamp with E27 base. Trendy spherical shape.

DE Eine Serie von Landschaftsleuchten. Rahmenmaterial: Kunststoff, Farbton: Weiß. Hoher Schutzgrad gegen Staub und Feuchtigkeit: IP 54. Lichtquelle: Leuchtmittel mit E27-Fassung. Trendige Kugelform.

IT Una serie di lampade da esterno. Materiale della corpo – plastica, colore – bianco. Elevato livello di protezione contro polvere e umidità IP54. La sorgente luminosa è una lampadina con attacco E27. Forma sferica alla moda.

FR Série de luminaires paysagers. Matériau du corps : plastique, couleur : blanc. Haut niveau de protection contre la poussière et l'humidité IP54. Source de lumière : ampoule à culot E27. Forme sphérique tendance.



1



3



2

1 **O594FL-01W**

💡 1 x E27 30 W
IP 54

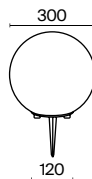

2 **O594PL-01W**
 O594PL-01B

💡 1 x E27 30 W
IP 54

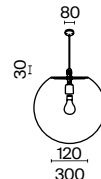

3 **O594FL-01W1**

💡 1 x E27 30 W
IP 54

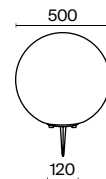



O594FL-01W

O594FL-01W1

Essen

B GR

IP54 LED

EN Body material – aluminum, shades – black, grey. IP54. Protection against corrosion and temperature differences. Light source – LED module with color temperature of 4000K. Minimalistic design. The series includes landscape lamps of various height.

DE Aluminiumrahmen, Farbtöne: Schwarz, Grau. IP54. Schutz vor Korrosion und Temperaturschwankungen. Lichtquelle: LED-Modul mit einer neutralen Farbtemperatur von 4000K. Minimalistisches Design. Die Serie wird durch Landschaftsleuchten in verschiedenen Höhen dargestellt.

IT Materiale del corpo: alluminio, tonalità: nero, grigio. IP54. Protezione dalla corrosione e dagli sbalzi di temperatura. La sorgente luminosa è un modulo LED con temperatura di colore di 4000K. Design minimalista. La serie è rappresentata da lampade da esterno di varie altezze.

FR Matériau du corps : aluminium, teintes : noir, gris. IP54. Protection contre la corrosion et les changements de températures. Source de lumière : module LED avec une température de couleur de 4000K. Design minimaliste. Série de luminaires paysagers proposée dans différentes hauteurs.



1 ■ ■



2 ■ ■

1 ■ **O596FL-L9B4K**
■ **O596FL-L9GR4K**

LED 9W 450lm
t° 4000K >80Ra 55°
IP 54

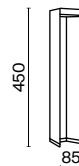

2 ■ **O596FL-L9B4K1**
■ **O596FL-L9GR4K1**

LED 9W 450lm
t° 4000K >80Ra 55°
IP 54

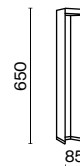



O596FL-L9B4K

Glide

GF

NEW

IP54



EN Case material – aluminum, shade – graphite. Lampshade made of durable tinted glass. Light source – lamp with an G9 base. A series for marker and decorative illumination of paths and landscape. Protection Code IP54.

DE Rahmenmaterial - Aluminium, Farbe - Graphit. Lampenschirm aus festem getöntem Glas. Lichtquelle - Leuchtmittel mit G9-Fassung. Serie zur Markierungs- und dekorativen Beleuchtung von Wegen und Landschaften. Schutzgrad - IP54.

IT Il materiale del corpo è alluminio, il colore è grafite. Il paralume è un vetro colorato resistente. La fonte dell'illuminazione è una lampadina con un portalampada G9. Serie per evidenziatore e un illuminazione decorativa dei percorsi e dei paesaggi. Il grado di protezione è IP54.

FR Matériau du corps - aluminium, couleur - graphite. L'abat-jour est en verre fumé durable. Source de lumière - lampe avec culot G9. Série pour l'éclairage de balisage et décoratif de sentiers et de paysages. Degré de protection - IP54.



1 ■ **O437FL-01GF**

💡 1 × G9 20 W
IP 54

2 ■ **O437FL-01GF1**

💡 1 × G9 20 W
IP 54

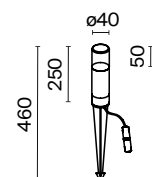
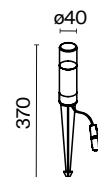

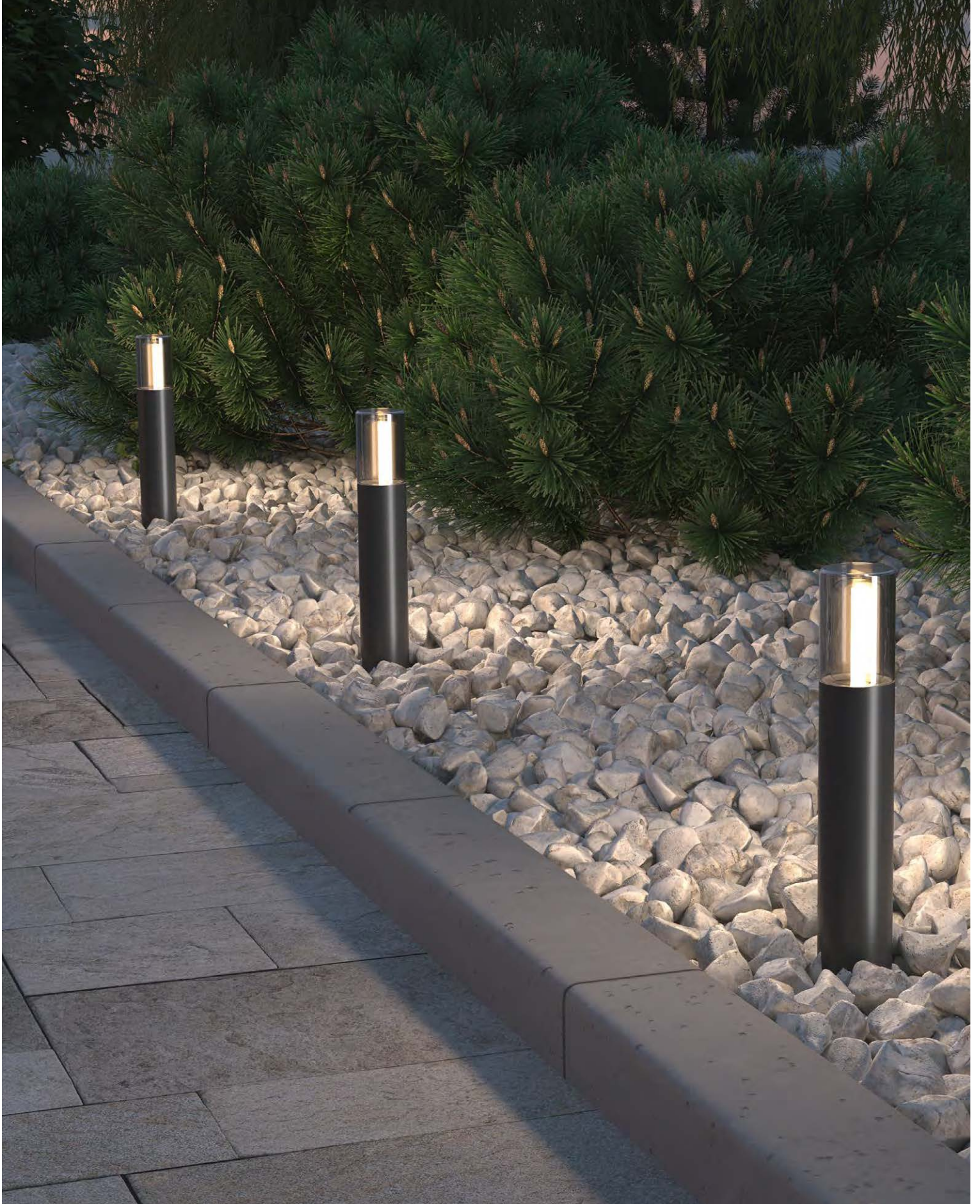

O437FL-01GF1

Gloss

GF



EN Aluminum body, shade - graphite. Diffuser is made of white matte acrylic. Included is a plate made of transparent plastic for marking (house numbers, etc.). LED light source, color temperature - 3000K. Protection Code IP54.

DE Aluminiumrahmen, Farbe - Graphit. Diffusor aus weißem mattem Acryl. Im Lieferumfang enthalten ist eine transparente Kunststoffplatte zur Beschriftung (Hausnummer usw.). LED-Lichtquelle, Farbtemperatur - 3000K. Schutzgrad IP54.

IT Corpo in alluminio, il colore è grafite. Diffusore in acrilico bianco opaco. Incluso una targa in plastica trasparente per l'applicazione di designazioni (numeri civici, ecc.). Sorgente luminosa a LED. La temperatura di colore è 3000K. Il grado di protezione è IP54.

FR Corps en aluminium, couleur - graphite. Diffuseur en acrylique blanc mat. Une plaque en plastique transparente est incluse pour le marquage (numéros de maison, etc.). Source de lumière LED, température de couleur 3000K. Degré de protection IP54.



1 ■

1 ■ **O447WL-L7GF3K**

LED 7W 500lm
t° 3000K >80Ra 108°
IP 65

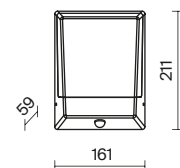



O447WL-L7GF3K

Guss

GF

NEW

IP65

LED



EN Case material – aluminum, shade – graphite. The original design of the case – accent element of landscape design. LED light source, color temperature - 3000K. Protection Code – IP65.

DE Rahmenmaterial - Aluminium, Farbe - Graphit. Eigenartiges Rahmendesign - Akzentelement der Landschaftsgestaltung. LED-Lichtquelle, Farbtemperatur - 3000K. Hoher Schutzgrad - IP65.

IT Il materiale del corpo è alluminio, il colore è grafite. Il design originale del corpo è un elemento di accento del design del paesaggio. Sorgente luminosa a LED. La temperatura di colore è 3000K. L'alto grado di protezione è IP65.

FR Matériau du corps - aluminium, couleur - graphite. La conception originale du corps - est un élément d'accent de l'aménagement paysager. Source de lumière LED, température de couleur - 3000K. Haut degré de protection - IP65.

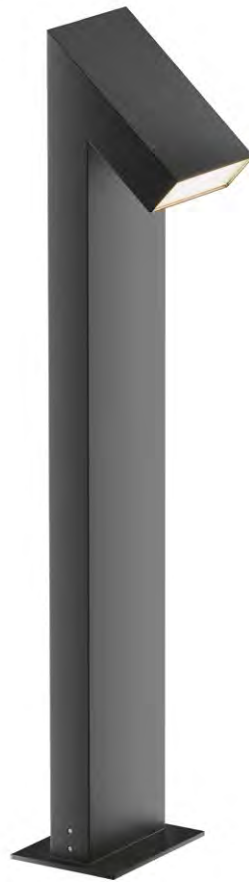

1 ■

1 ■ **O592FL-L15GF3K**

LED 15 W 1000lm
t° 3000K >80Ra 90°
IP 65

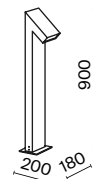

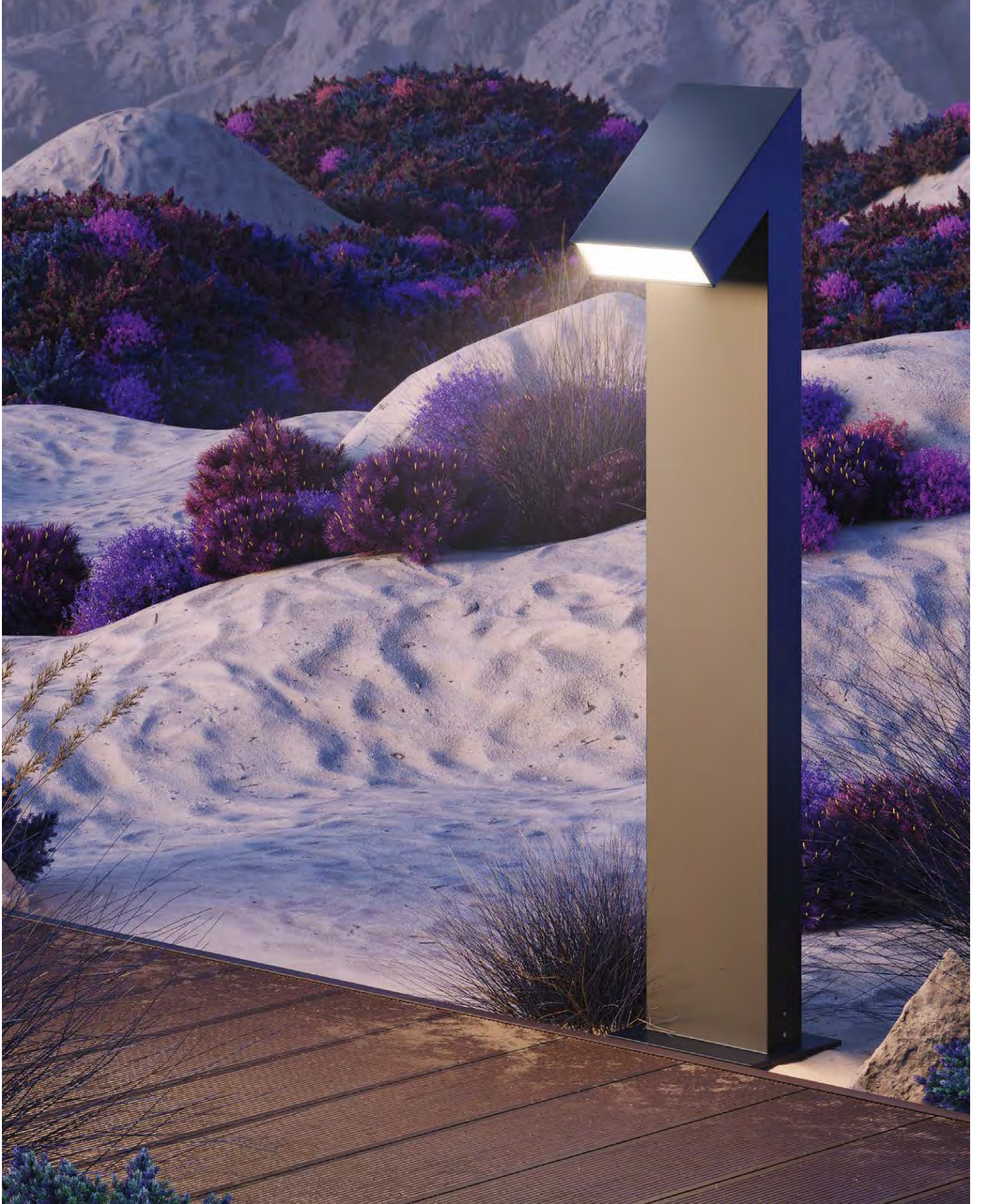

O592FL-L15GF3K

Hagen

GF

IP65

LED



EN Landscape lamp. Metal body, graphite color. Corrosion resistant and temperature fluctuations. High level IP65. LED module with a color temperature of 3000K.

DE Leuchte für die Landschaft. Metallrahmen, Farbton: Graphit. Widerstandsfähig gegen Korrosion und Temperaturschwankungen. Hohe Schutzart IP65. LED-Modul mit Farbtemperatur 3000K.

IT Lampada da paesaggio. Corpo in metallo, colore grafite. Resistente alla corrosione e sbalzi di temperatura. Alto livello di IP65. Modulo LED con temperatura di colore di 3000K.

FR CLampe paysage. Corps en métal, couleur graphite. Résistant à la corrosion Résistant à la corrosion, aux fluctuations de température. Haut niveau IP65. Module LED avec une température de couleur de 3000K.



1 ■

1 ■ **O423FL-L5GF**

LED 5W 200lm
t° 3000K >80Ra 51°
IP 65

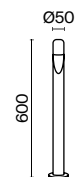

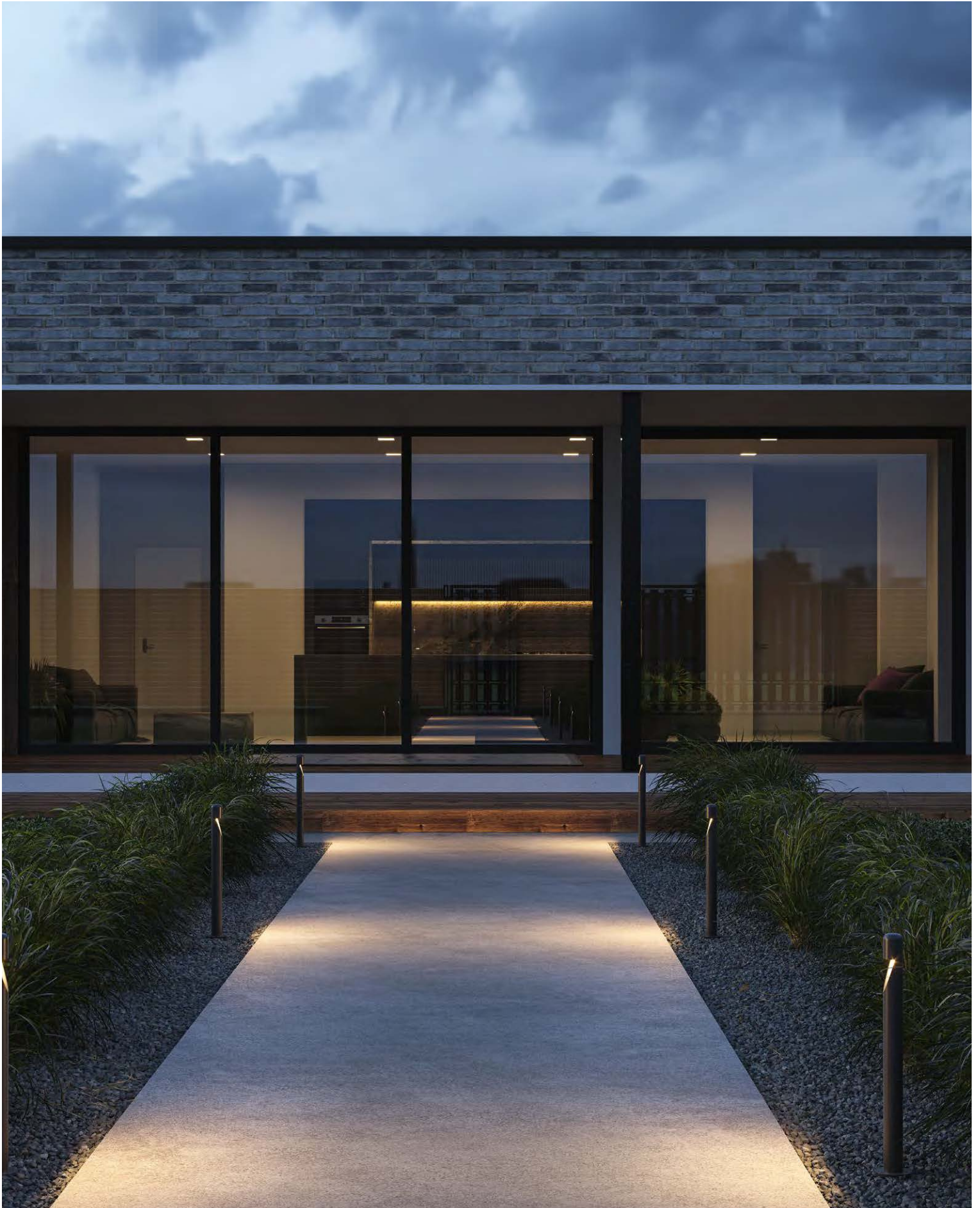

O423FL-L5GF

Hof

GF

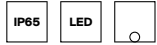

EN Series of landscape lamps. Body – metal, color – graphite. LED module. Color temperature is 3000K. High level IP65. Protection against corrosion and temperature differences. Modern minimalistic design.

DE Eine Serie von Landschaftsleuchten. Metallrahmen, Farbton: Graphit. LED-Modul. Farbtemperatur 3000K. Hoher Schutzgrad IP65. Schutz vor Korrosion und Temperaturschwankungen. Modernes, minimalistisches Design.

IT Serie di lampade da esterno. Corpo – metallo, colore – grafite. Modulo LED. Temperatura di colore 3000K. IP65 di alto livello. Protezione dalla corrosione e dagli sbalzi di temperatura. Design moderno e minimalista.

FR Série de luminaires paysagers. Corps : métal, couleur: graphite. Module LED. Température de couleur 3000K. Haut niveau de protection IP65. Protection contre la corrosion et les changements de températures. Design minimaliste moderne.



1 ■ **O422FL-L6GF**

LED 6W 200lm
t° 3000K >80Ra 90°
IP 65

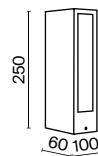

2 ■ **O422FL-L12GF**

LED 12W 450lm
t° 3000K >80Ra 90°
IP 65



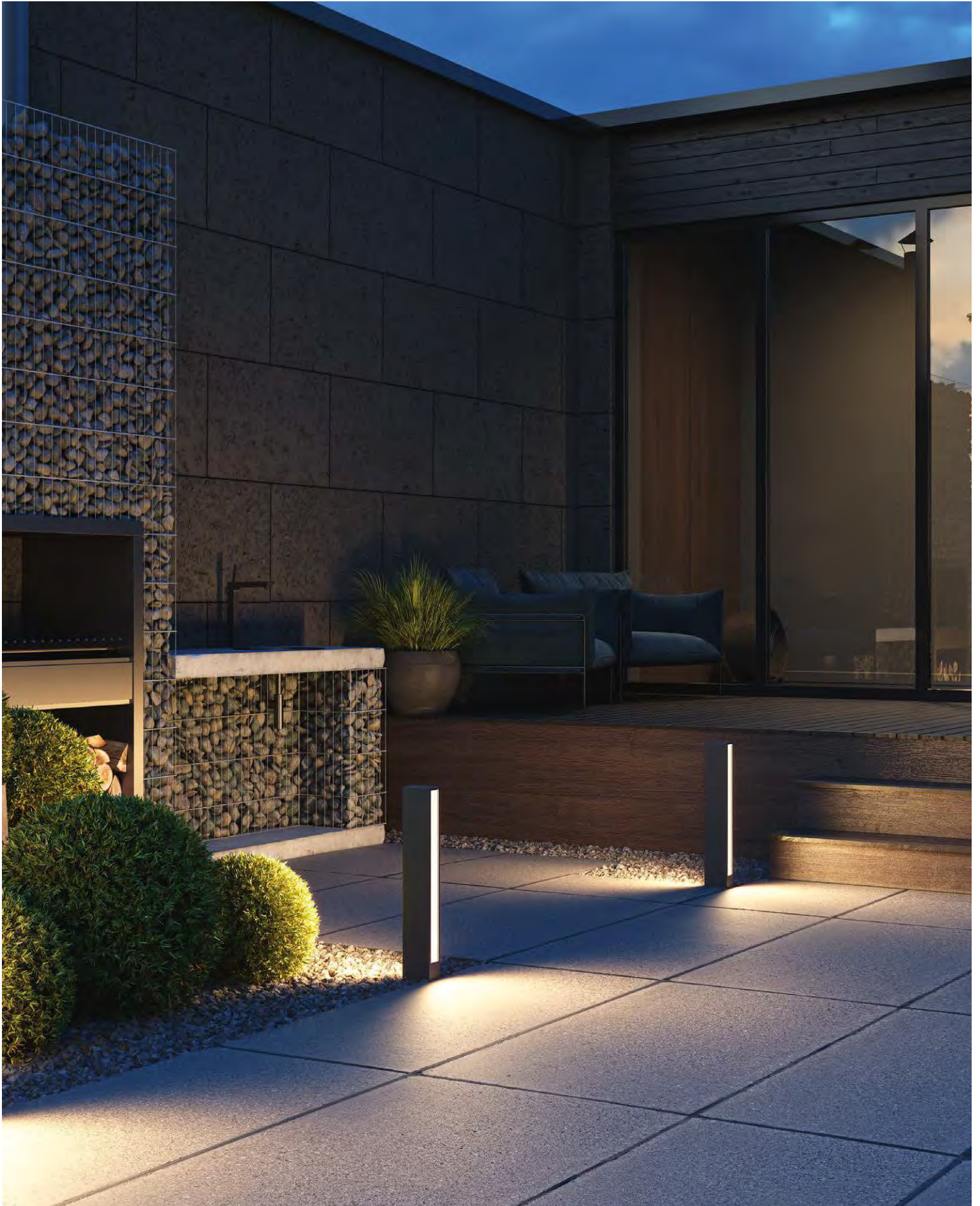

O422FL-L12GF

Koln

B



EN Aluminum body in black color. Resistant to corrosion and temperature differences. High protection class against dust and moisture IP54. LED module with color temperature of 4000K. The series includes wall and landscape lamps.

DE Aluminiumrahmen in Schwarz. Beständig gegen Korrosion und Temperaturschwankungen. Hoher Schutzgrad gegen Staub und Feuchtigkeit: IP 54. LED-Modul mit einer Farbtemperatur von 4000K. Die Serie umfasst Wand- und Landschaftsleuchten.

IT Corpo in alluminio nero. Resistente alla corrosione e agli sbalzi di temperatura. Elevata classe di protezione contro polvere e umidità IP54. Modulo LED con temperatura di colore 4000K. La serie comprende lampade da parete e da esterno.

FR Corps en aluminium de couleur noire. résistance à la corrosion et aux changements de températures. Haute classe de protection contre la poussière et l'humidité IP54. Module LED avec une température de couleur de 4000K. La série comprend des appliques murales et des luminaires paysagers.



1 ■



2 ■



3 ■

1 ■ **O590WL-L8B4K**

LED 8 W 450lm
t° 4000K >80Ra 185°
IP 54

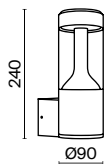

2 ■ **O590FL-L8B4K**

LED 8 W 450lm
t° 4000K >80Ra 185°
IP 54

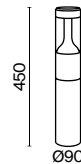

3 ■ **O590FL-L8B4K1**

LED 8 W 450lm
t° 4000K >80Ra 185°
IP 54

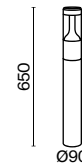



O590FL-L8B4K

O590WL-L8B4K

SPECTACULAR MOMENTS OF OUTDOOR LIGHTING



In the realm of lighting fixtures, I stand as a paragon of excellence. With an aluminum body, I exude robustness and dependability, readily accommodating various climatic exigencies. My chic embossed glass plafonds, both aesthetically alluring and functionally astute, diffuse light with a gentle and uniform grace.

My durability and efficiency are attributed to the LED light sources, which ensure luminous brilliance for years on end. Further bolstering my prowess, I bear an impressive IP65 rating, rendering me impervious to the vagaries of moisture and dust. Indeed, I remain unfazed by the rigors of frequent maintenance.

My primary objective is to effervescently illuminate expanses, dispelling darkness and rendering paths and grounds conspicuously visible, even in the darkest of nights. I proffer not merely illumination but an artful spectacle, one that accentuates the splendor of your landscape.



Lit

BR GF

NEW IP65 LED

EN Aluminum body, shades – graphite, brown. Double lampshade made of glass. The outer one is transparent with a linear relief pattern. The inner one is a white glossy diffuser. Models with power varying from 12W to 20W designed for main lighting. LED light source, color temperature - 3000K. Protection Code – IP65.

DE Aluminiumrahmen, Farben - Graphit, Braun. Doppelter Lampenschirm aus Glas. Außenseite - transparent mit einem linearen geprägtem Muster. Innenseite - weißer glänzender Diffusor. Modelle von 12W bis 20W - konzipiert für die Grundbeleuchtung. LED-Lichtquelle, Farbtemperatur - 3000K. Hoher Schutzgrad - IP65.

IT Il corpo è in alluminio, i colori sono grafite, marrone. Doppio paralume in vetro. L'esterno paralume è trasparente con un motivo a rilievo lineare. L'interno paralume è un diffusore bianco lucido. I modelli di potenza da 12 W a 20 W sono progettati per l'illuminazione principale. Sorgente luminosa a LED. La temperatura di colore è 3000K. L'alto grado di protezione è IP65.

FR Corps - aluminium, couleurs - graphite, marron. Abat-jour double en verre. L'extérieur est transparent avec un motif en relief linéaire. L'intérieur - un diffuseur blanc brillant. Les modèles d'une puissance de 12W à 20W sont destinés à l'éclairage principal. Source de lumière LED, température de couleur - 3000K. Haut degré de protection - IP65.



1 ■ **O593FL-L12BR3K**
■ **O593FL-L12GF3K**

2 ■ **O593FL-L20BR3K**
■ **O593FL-L20GF3K**

LED 12W 600lm
t° 3000K >80Ra 90°
IP 65

LED 20W 850lm
t° 3000K >80Ra 90°
IP 65

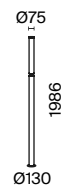
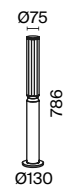



O593FL-L12GF3K

Lot

GF W

NEW IP65 LED

EN Body materials: aluminium and glass. Shades: white, graphite. Corrosion-resistant. LED light source, color temperature: 3000K. Color rendering index: 80Ra. High degree of protection against dust and moisture: IP65.



DE Gehäuse aus Aluminium und Glas. Farbtöne: weiß, Graphit. Korrosionsbeständig. LED-Lichtquelle, Farbtemperatur - 3000K. Farbwiedergabeindex: 80Ra. Hoher Schutzart vor Staub und Feuchtigkeit: IP 65.

IT I materiali del corpo sono l'alluminio e il vetro. Le tonalita' sono bianco, grafite. Resistente alla corrosione. La sorgente luminosa a LED, la temperatura di colore e' 3000K. L'indice di resa cromatica e' 80Ra. L'alto grado di protezione dalla polvere e l'umidità e' IP65.

FR Matériaux du boîtier - aluminium et verre. Teintes - blanc, graphite. Résistant à la corrosion. Source de lumière LED, température de couleur - 3000K. Indice de rendu des couleurs - 80Ra. Haut degré de protection contre la poussière et l'humidité - IP65.





1 

1  **O428WL-L20GF3K**
 **O428WL-L20W3K**

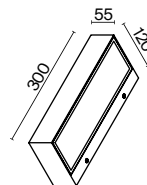
LED 20 W 700lm
t° 3000K >80Ra 300°
IP 65



2  **O428WL-L10GF3K**
 **O428WL-L10W3K**

LED 10 W 350lm
t° 3000K >80Ra 150°
IP 65

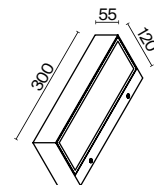



Mill

GF

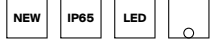

EN Aluminium body. Corrosion protection. Color: graphite. LED light source, color temperature: 3000K. High degree of protection against dust and moisture: IP65. Two power options. Designed for basic lighting of suburban areas.

DE Aluminiumgehäuse. Korrosionsschutz. Graphitfarben. LED-Lichtquelle, Farbtemperatur - 3000K. Hoher Schutzart vor Staub und Feuchtigkeit: IP65. Zwei Leistungsstufen. Bestimmt für Beleuchtung der außerstädtischen Grundstücke.

IT Il corpo e' fatto in alluminio. Una protezione anticorrosiva. Il colore è grafite. La sorgente luminosa a LED, la temperatura di colore e' 3000K. L'alto grado di protezione dall'umidità e dalla polvere e' IP65. Le due opzioni di una potenza. Progettato per l'illuminazione generale delle aree suburbane.

FR Corps en aluminium. Protection contre la corrosion. Couleur - graphite. Source de lumière LED, température de couleur - 3000K. Haut degré de protection contre l'humidité et la poussière - IP65. Deux options de puissance. Conçu pour l'éclairage principal des zones suburbaines.

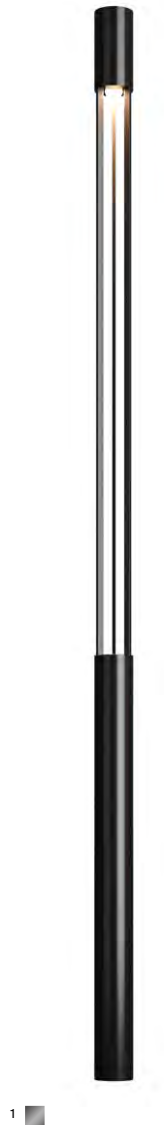
1 ■ **O427FL-L12GF3K**

LED 12W 1000lm
t° 3000K >80Ra 36°
IP 65

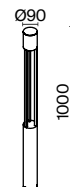
2 ■ **O427FL-L30GF3K**

LED 30W 2200lm
t° 3000K >80Ra 36°
IP 65

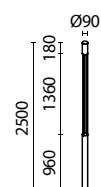



O427FL-L12GF3K

Olten

GF

NEW

IP65

LED



EN Aluminium fittings. Shade: graphite. LED light source, color temperature: 3000K. Color rendering index: 80Ra. High degree of protection against dust and moisture: IP65. Designed for basic lighting.

DE Aluminiumbeschläge. Farbtöne: Graphit. LED-Lichtquelle, Farbtemperatur - 3000K. Farbwiedergabeindex: 80Ra. Hoher Schutzart vor Staub und Feuchtigkeit: IP65. Bestimmt für Normalbeleuchtung

IT Il materiale dell'armatura è l'alluminio. La tonalità è grafite. La sorgente luminosa a LED, la temperatura di colore è 3000K. L'indice di resa cromatica è 80Ra. L'alto grado di protezione dalla polvere e dall'umidità è IP65. Progettato per l'illuminazione generale.

FR Matériau de l'armature - aluminium. Teinte - graphite. Source de lumière LED, température de couleur - 3000K. Indice de rendu des couleurs - 80Ra. Haut degré de protection contre la poussière et l'humidité - IP65. Conçu pour l'éclairage principal.



1 ■



2 ■

1 ■ **O591FL-L12GF3K1**

LED 12W 280lm
t° 3000K >80Ra 55°
IP 65

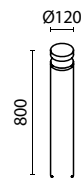
2 ■ **O591FL-L12GF3K**

LED 12W 280lm
t° 3000K >80Ra 55°
IP 65

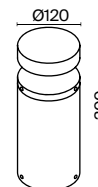



O595FL-L12B3K

Paso

B



EN "Paso" series includes wall and landscape lamps that make it possible to illuminate the area and adjoining territory in the same style. Power of 12W and color temperature of 3000K are optimal for comfortable diffused lighting. The body of the lamps are made of high-quality aluminum with powder coating, which ensures the reliability and long service life.

DE Die Paso-Serie umfasst Wand- und Landschaftsleuchten, die es ermöglichen, die Beleuchtung des Grundstücks und der am Haus gelegenen Fläche in einem einheitlichen Stil zu realisieren. Die Leistung von 12 W und die Farbtemperatur von 3000K sind optimal für ein angenehmes diffuses Licht. Rahmen der Leuchten ist aus hochwertigem, pulverbeschichtetem Aluminium gefertigt und garantiert eine zuverlässige und lange Lebensdauer.

IT La serie Paso comprende lampade da parete e da esterno, che consentono di realizzare l'illuminazione del terreno e dell'area pertinente nello stesso stile. La potenza di 12W e la temperatura di colore di 3000K sono ottimali per un'illuminazione diffusa e confortevole. Il corpo delle lampade è realizzato in alluminio di alta qualità con verniciatura a polvere, che garantisce affidabilità e lunga durata.

FR La série Paso comprend des appliques murales et des luminaires paysagers, ce qui permet de réaliser l'éclairage d'un secteur et du territoire attenant à la maison dans un style uni. La puissance de 12W et la température de couleur de 3000K sont optimales pour une diffusion confortable de l'éclairage. Le corps des luminaires est en aluminium de haute qualité avec un revêtement par poudre, ce qui garantit la fiabilité et une longue durée exploitation.

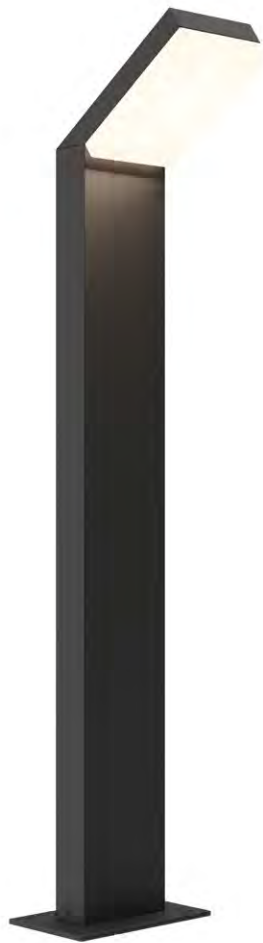

1 ■



2 ■

1 ■ **O595FL-L12B3K**

LED 12W 660lm
 t° 3000K >80Ra 97°
 IP 54

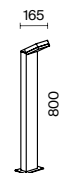

2 ■ **O595WL-L12B3K**

LED 12W 865lm
 t° 3000K >80Ra 97°
 IP 54

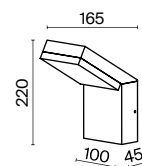

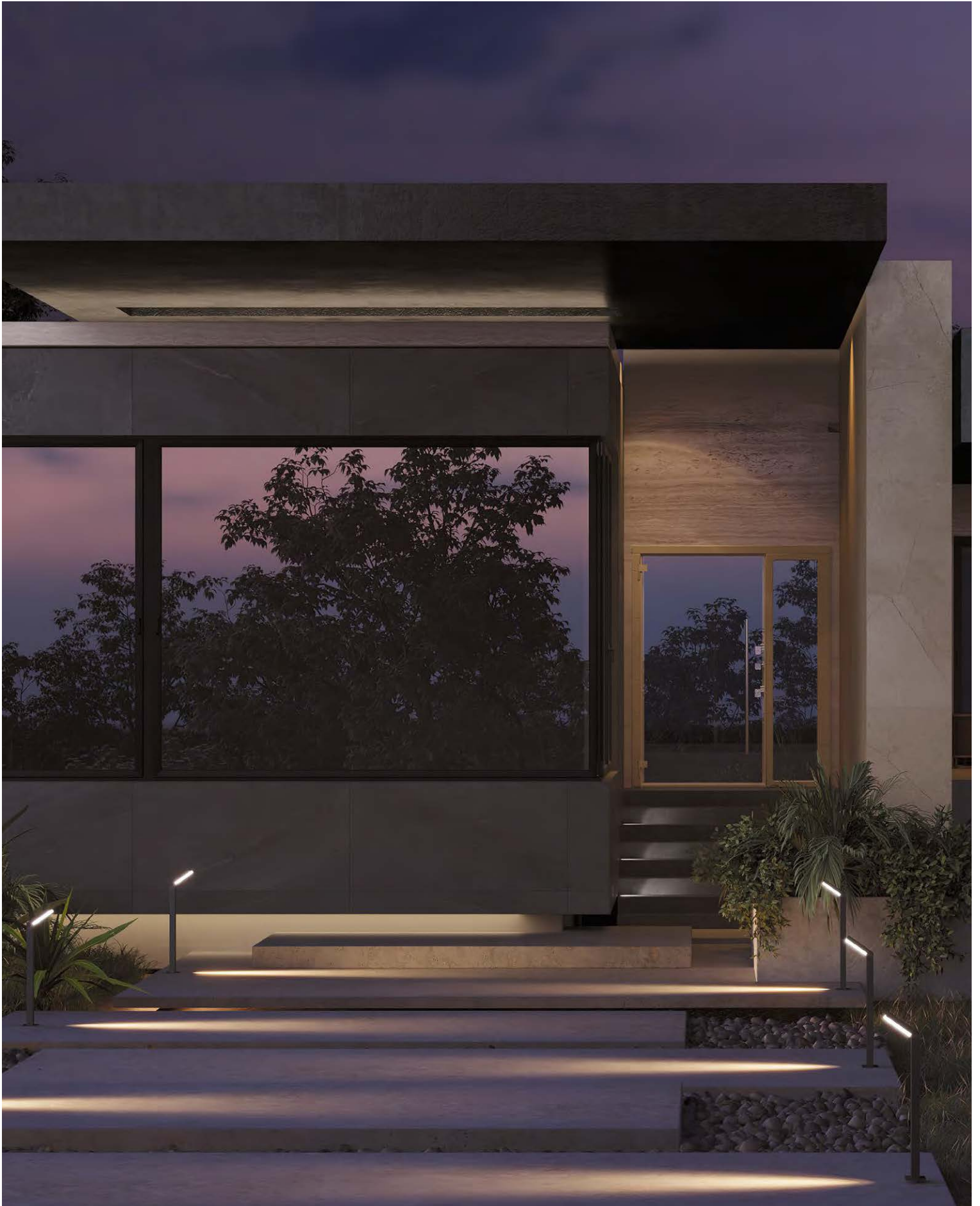

Pir

GF

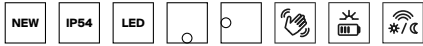

EN Aluminum body, shade - graphite. Powered by a solar battery, no wires and no need to connect to electricity. Works up to 14 hours without recharging. Built-in motion sensor. Three modes of operation. LED light source, color temperature - 3000K. Lamps for decorative and marking illumination. Protection Code IP54.

DE Aluminiumrahmen, Farbe - Graphit. Solarbetrieben, keine Kabel und keine Notwendigkeit des Stromanschlusses. Arbeitet bis zu 14 Stunden ohne Aufladen. Eingebauter Bewegungssensor. Drei Betriebsarten. LED-Lichtquelle, Farbtemperatur - 3000K. Leuchten für dekorative und Markierungsbeleuchtung. Schutzgrad - IP54.

IT Corpo e' in alluminio, il colore è grafite. L'alimentazione e' da un pannello solare, nessun cablaggio e necessita' di connessione elettrica. Una lavorazione fino a 14 ore con una singola carica. Il sensore di movimento incorporato. Tre modalità di funzionamento. Sorgente luminosa a LED, la temperatura di colore e' 3000K Le lampade per l'illuminazione decorativa e di marcatura. Il grado di protezione e' IP54.

FR Corps en aluminium, couleur - graphite. Alimenté par un panneau solaire, pas de fils ni besoin de se connecter à l'électricité. Fonctionnement jusqu'à 14 heures sans recharge. Capteur de mouvement intégré. Trois modes de fonctionnement. Source de lumière LED, température de couleur - 3000K. Lampes pour éclairage d'intérieur et de marquage. Degré de protection - IP54.



1 ■ **OSL456FL-L2GF3K**

LED 2W 150lm
t° 3000K >80Ra 90°
IP 54

2 ■ **OSL456WL-L2GF3K**

LED 2W 150lm
t° 3000K >80Ra 93°
IP 54

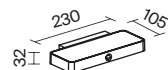
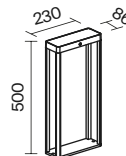



OSL456WL-L2GF3K

SPECTACULAR MOMENTS OF OUTDOOR LIGHTING

I am the epitome of natural beauty, adorned in an elegant tapestry of hand-woven rattan. My inherent naturalness is intrinsic to my purpose – to enchant with unadulterated beauty and to seamlessly meld with the verdant surroundings, whether amidst summer's verdant landscapes or amid the wintry embrace of fluffy countryside drifts.

The exquisite black attire I sport endows me with a sense of style and sophistication. Moreover, my solar-powered operation permits me to radiate resplendently for up to 12 uninterrupted hours, unburdened by the need for a power source.

I graciously emanate a soft, ambient glow, instilling a sense of coziness in the obscurity, akin to the fabric of a fairy tale, capable of magically metamorphosing your gardens, terraces, and pergolas.

I anticipate your movements, courtesy of my built-in sensor, promptly illuminating at the opportune moment, rendering your life more convenient and conserving energy.



Plet

B



EN Case made of hand-woven rattan, shade – black. Powered by a solar battery, the operating time is up to 12 hours without recharging. LED light source, color temperature - 3000K. Could be installed anywhere due to lack of wires. Convenient carrying handles. Protection Code – IP65. Built-in motion sensor. Series for decorative lighting.

DE Rahmen aus handgeflochtenem Rattan, Farbe - Schwarz. Solarbetrieben, bis zu 12 Stunden Betrieb ohne Aufladen. LED-Lichtquelle, Farbtemperatur - 3000K. Kann überall installiert werden, da keine Kabel vorhanden sind. Bequeme Tragegriffe. Hoher Schutzgrad - IP65. Eingebauter Bewegungssensor. Serie für dekorative Beleuchtung.

IT Corpo e' in rotan intrecciato a mano, il colore è nero. L'alimentazione da una batteria solare, il periodo di lavoro è fino a 12 ore con una singola carica. Sorgente luminosa a LED, la temperatura di colore e'3000K. Può essere installato ovunque a causa della mancanza di cavi. Le comode maniglie per il trasporto. L'alto grado di protezione IP65. Il sensore di movimento incorporato. Una serie per l'illuminazione decorativa.

FR Corps en rotin tressé à la main, couleur noir. Alimenté par une batterie solaire, durée de fonctionnement - jusqu'à 12 heures sans recharge. Source de lumière LED, température de couleur - 3000K. Possibilité d'installation n'importe où grâce à l'absence de fils. Poignées de transport pratiques. Haut degré de protection IP65. Capteur de mouvement intégré. Série pour éclairage décoratif.



1 ■



2 ■

1 ■ **OSL599FL-L5B3K**

LED 5W 250lm
 t° 3000K >80Ra 90°
 IP 65

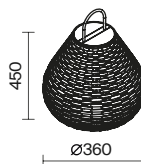
2 ■ **OSL599FL-L5B3K1**

LED 5W 250lm
 t° 3000K >80Ra 90°
 IP 65

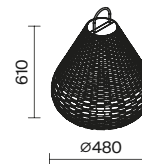



OSL599FL-L5B3K

OSL599FL-L5B3K1

Rando



EN Metal body, shades – black, grey, white. Corrugated texture. High level IP54, corrosion protection. Option to adjust one and two-way backlight. Light source – lamp with E27 base.

DE Metallrahmen, Farbtöne: Schwarz, Grau, Weiß. Geprägte Textur. Hoher Schutzgrad IP54, Schutz vor Korrosion. Möglichkeit zur Einstellung der ein- und bidirektionalen Beleuchtung. Lichtquelle: Leuchtmittel mit E27-Fassung.

IT Corpo in metallo, tonalità: nero, grigio, bianco. Trama in rilievo. Alto livello IP54, protezione dalla corrosione. Possibilità di configurare l'illuminazione unidirezionale e bidirezionale. La sorgente luminosa è una lampadina con attacco E27.

FR Corps métallique, teinte : noir, gris, blanc. Texture en relief. Haut niveau de protection IP54, protection contre la corrosion. Possibilité de réglage d'éclairage uni et bidirectionnel. Source de lumière : ampoule à culot E27.



- 1 ■ **O419WL-02B**
 ■ **O419WL-02GR**
 □ **O419WL-02W**

- 2 ■ **O419WL-01B**
 ■ **O419WL-01GR**
 □ **O419WL-01W**

💡 2 × E27 60 W
 IP 54

💡 1 × E27 60 W
 IP 54

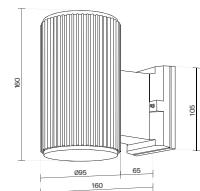
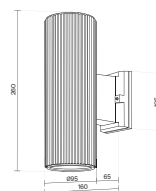



O419WL-02B

Rock

GF

NEW

IP54

LED

○

EN Aluminium body, color: graphite. A rounded plastic diffuser provides a large area of uniform and saturated light. LED light source. Color temperature: 3000K. Protection rating: IP54.

DE Aluminiumgehäuse, graphitfarben. Kugelförmiger Diffusor aus Kunststoff, der eine große Fläche des gleichförmigen und satten Lichtes gewährleistet. LED-Lichtquelle, Farbtemperatur - 3000K. Schutzart: IP54.

IT Il corpo e' in alluminio, il colore è grafite. Il diffusore arrotondato fatto in plastic e' una vasta area di luce uniforme e ricca. La sorgente luminosa a LED. La temperatura di colore e' 3000K. Il grado di protezione e' IP54.

FR Corps en aluminium, couleur - graphite. Diffuseur arrondi en plastique - une grande zone de lumière uniforme et saturée. Source de lumière LED. Température de couleur - 3000K. Degré de protection - IP54.



1 ■

1 ■ **O434WL-L12GF3K**

LED 12W 600lm
t° 3000K >80Ra 243°
IP 54

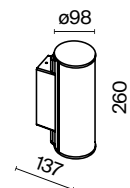



O434WL-L12GF3K

Roll

B

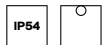

EN Compact ceiling lamp. Body material – aluminum, color – black. High protection class IP54. Body is resistant to corrosion and temperature differences. Light source – lamp with GU10 base.

DE Kompakte Deckenleuchte. Rahmenmaterial: Aluminium, Farbton: Schwarz. Hohe Schutzart IP54. Rahmen ist gegen Korrosion und Temperaturschwankungen beständig. Lichtquelle: Leuchtmittel mit GU10-Fassung.

IT Lampada da soffitto compatta. Materiale della corpo – alluminio, colore – nero. Grado di protezione elevato IP54. Il corpo è resistente alla corrosione e agli sbalzi di temperatura. La sorgente luminosa è una lampadina con attacco GU10.

FR Plafonnier compact. Matériau du corps : aluminium, couleur : noir. Haute classe de protection IP54. Corps résistant contre la corrosion et les changements de températures. Source de lumière : ampoule à culot GU10.



1 ■

1 ■ **O307CL-01B**

1 × GU10 50 W
IP 54

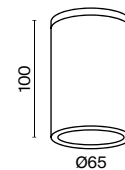



O307CL-01B

Rom

GF

NEW IP54 LED 

EN Case made of aluminum, shade – graphite. Diffuser – white matte acrylic. Uniform soft light scattering. LED light source, color temperature - 3000K. Protection Code IP54.

DE Aluminiumrahmen, Farbe - Graphit. Diffusor aus weißem mattem Acryl. Gleichmäßige, weiche Streuung des Lichts. LED-Lichtquelle, Farbtemperatur - 3000K. Schutzgrad - IP54.

IT Il corpo e' in alluminio, il colore è grafite. Il diffusore è acrilico bianco opaco. Diffusione uniforme della luce morbida. Sorgente luminosa a LED, la temperatura di colore e' 3000K. Il grado di protezione e' IP54.

FR Corps en aluminium, couleur - graphite. Diffuseur - acrylique blanc mat. Dispersion douce et uniforme de la lumière. Source de lumière LED, température de couleur - 3000K. Degré de protection - IP54.



1 



2 

1  **O442WL-L12GF3K1**

LED 12W 950lm
t° 3000K >80Ra 90°
IP 54

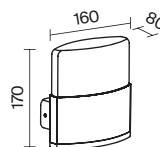

2  **O442WL-L12GF3K**

LED 12W 900lm
t° 3000K >80Ra 90°
IP 54

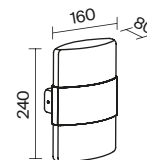



O442WL-L12GF3K

O442WL-L12GF3K1

Row

GF



EN Case material – aluminum, shade – graphite. Original diffuser is made of white frosted glass with the ability to apply digital designations (house number, etc.). Set of numbers provided. LED light source, color temperature - 3000K. Protection Code IP44.

DE Rahmenmaterial - Aluminium, Farbe - Graphit. Eigenartiger Diffusor aus weißem Milchglas mit der Möglichkeit, verschiedene Bezeichnungen anzubringen (Hausnummer usw.). Ziffernsatz im Lieferumfang. LED-Lichtquelle, Farbtemperatur - 3000K. Schutzgrad - IP44.

IT Il materiale del corpo è alluminio, il colore è grafite. Il diffusore originale in vetro opaco bianco con la possibilità di applicare designazioni digitali (numero civico, ecc.). Kit di numeri inclusi. Sorgente luminosa a LED, la temperatura di colore è 3000K. Il grado di protezione è IP44.

FR Matériau du corps - aluminium, couleur - graphite. Un diffuseur original en verre dépoli blanc avec possibilité d'apposer des désignations numériques (numéro de maison, etc.). Un ensemble de chiffres inclus. Source de lumière LED, température de couleur 3000K. Degré de protection - IP44.



1 ■

1 ■ **O448WL-L9GF3KSR**

LED 11W 500lm
t° 3000K >80Ra 117°
IP 44

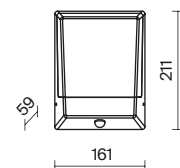



O448WL-L9GF3KSR

Share

GF

NEW

IP54

LED



EN Metal body. Part of the luminaires has a swivel mechanism for adjusting the light flux. In a series of models for putty, with a decorative frame and with a recessed GU10 lamp (not included).

DE Metallrahmen. Ein Teil der Leuchten ist mit einer Schwenkvorrichtung zur Einstellung des Lichtstroms ausgestattet. In einer Serie von Unterputz-Modellen, mit einem dekorativen Rahmen und mit einem versenkten Leuchtmittel mit GU10-Fassung (nicht im Lieferumfang enthalten).

IT Corpo in metallo. Parte degli apparecchi con meccanismo girevole per la regolazione del flusso luminoso. In una serie di modelli per mastice, con cornice decorativa e con lampada da incasso GU10 (non inclusa).

FR Corps métallique. Partie des LED avec un mécanisme pivotant pour le réglage du flux lumineux. Dans la série du modèle à poser sur support en plâtre, avec un cadre décoratif et une ampoule encastrée GU10 (non comprise dans le lot).



1



2

1 ■ **O443WL-L12GF3K**

LED 12W 850lm
t° 3000K >80Ra 108°
IP 54

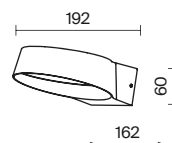

2 ■ **O443FL-L12GF3K**

LED 12W 850lm
t° 3000K >80Ra 108°
IP 54

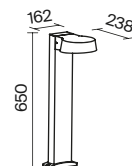



O443FL-L12GF3K

Shatter

GF



EN Aluminum body, shade - graphite. Powered by a solar battery, no wires and no need to connect to electricity. Works up to 14 hours without recharging. Built-in motion sensor. Three modes of operation. LED light source, color temperature - 3000K. Protection Code IP54.

DE Aluminiumrahmen, Farbe - Graphit. Solarbetrieben, keine Kabel und keine Notwendigkeit des Stromanschlusses. Arbeitet bis zu 14 Stunden ohne Aufladen. Eingebauter Bewegungssensor. Drei Betriebsarten. LED-Lichtquelle, Farbtemperatur - 3000K. Schutzgrad - IP54.

IT Il corpo e' alluminio, il colore è grafite. L'alimentazione e' da un pannello solare, nessun cablaggio e necessita' di connessione elettrica. Una lavorazione fino a 14 ore con una singola carica. Il sensore di movimento incorporato. Tre modalità di funzionamento. Sorgente luminosa a LED, la temperatura di colore e' 3000K. Il grado di protezione e' IP54.

FR Corps en aluminium, couleur - graphite. Alimenté par un panneau solaire, sans fils ni besoin de se connecter à l'électricité. Travaillez jusqu'à 14 heures sans recharge. Capteur de mouvement intégré. Trois modes de fonctionnement. Source de lumière LED, température de couleur - 3000K. Degré de protection - IP54.



1

1 ■ **OSL457WL-L2GF3K**

LED 2W 150lm
t° 3000K >80Ra 151°
IP 54

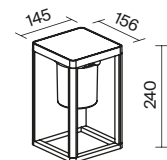



OSL457WL-L2GF3K

Spir

GF

NEW

IP54

LED



EN Aluminium body, color: graphite. A silver multi-layer cascade diffuser hides the LED light source preventing glare and softly diffusing the light. Color temperature: 3000K. Protection rating: IP54.

DE Aluminiumgehäuse, graphitfarben. Ein silberner mehrschichtiger Kaskadendiffusor verdeckt die LED-Lichtquelle, verhindert damit Blendung und streut das Licht sanft. Farbtemperatur: 3000K. Schutzart: IP54.

IT Corpo in alluminio, il colore è grafite. Il diffusore a cascata multistrato di color argento nasconde una sorgente luminosa a LED, prevenendo l'effetto di abbagliamento e diffondendo delicatamente la luce. La temperatura di colore è 3000K. Il grado di protezione è IP54.

FR Corps en aluminium, couleur - graphite. Un diffuseur en cascade multicouche argenté cache la source de lumière LED, empêchant l'éblouissement et diffuse doucement la lumière. Température de couleur - 3000K. Degré de protection - IP54.



1 ■



2 ■

1 ■ **O439FL-L12GF3K**

LED 12W 350lm
 t° 3000K >80Ra 162°
 IP 54

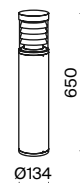

2 ■ **O439WL-L12GF3K**

LED 12W 350lm
 t° 3000K >80Ra 162°
 IP 54

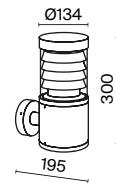

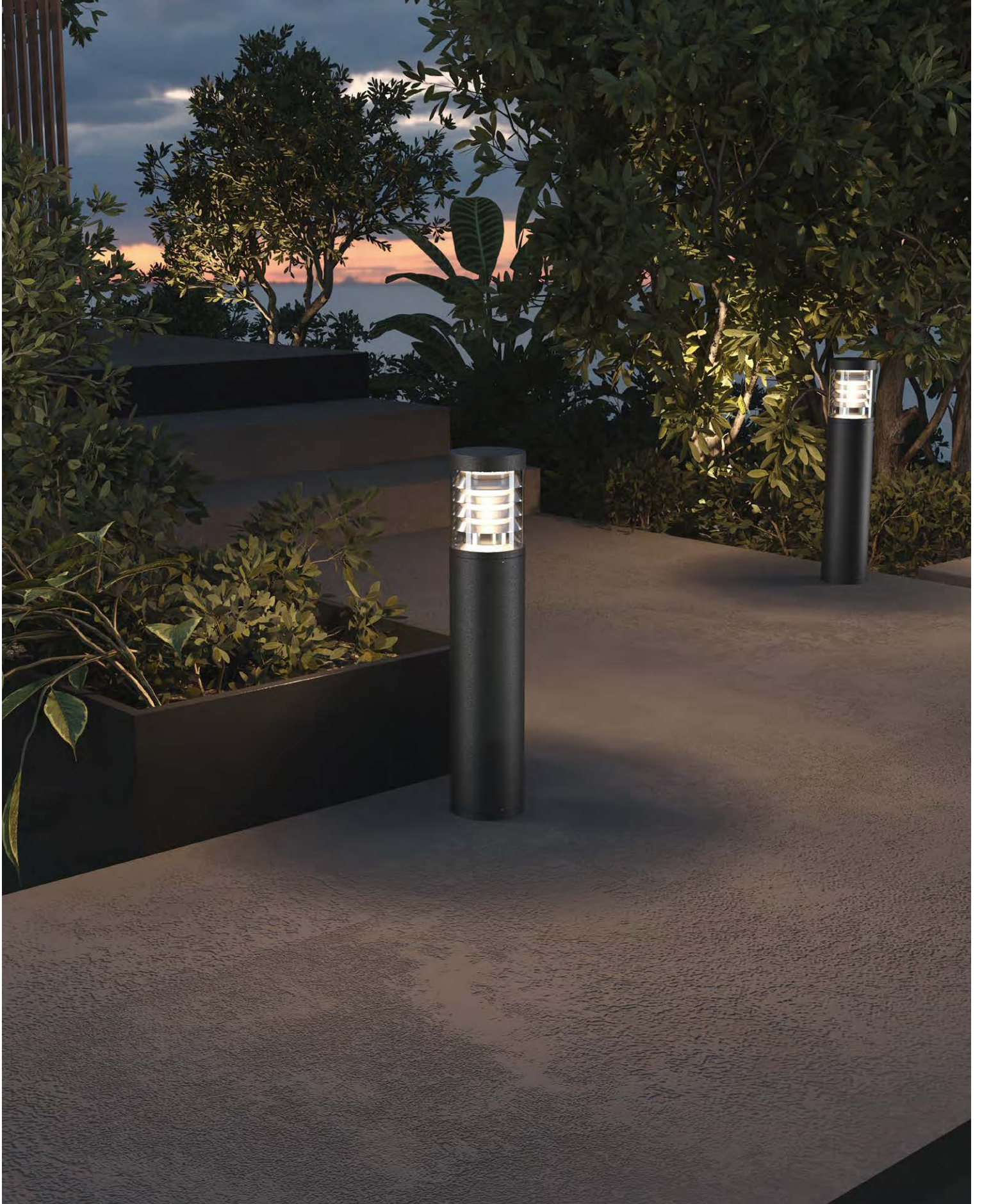

O439FL-L12GF3K

Stock

GF

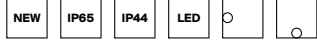

EN Case material – aluminum, shade – graphite. White matte diffuser. LED light source. Color temperature – 3000K. Built-in motion sensor for the wall model. Protection Code IP44.

DE Rahmenmaterial - Aluminium, Farbe - Graphit. Weißer matter Diffusor. LED-Lichtquelle. Farbtemperatur 3000K. Verfügbarkeit eines eingebauten Bewegungssensors im Wandmodell. Schutzgrad - IP54

IT Il materiale del corpo è alluminio, il colore è grafite. Il diffusore bianco opaco. Sorgente luminosa a LED. La temperatura del colore è di 3000K. La presenza di un sensore di movimento incorporato nel modello a parete. Il grado di protezione è IP54

FR Matériau du boîtier - aluminium, couleur - graphite. Diffuseur blanc mat. Source de lumière LED. Température de couleur 3000K. Le modèle mural dispose d'un capteur de mouvement intégré. Degré de protection IP54.



1 ■ **O446FL-L7GF3K**

LED 20W 450lm
 t° 3000K >80Ra 157°
 IP 65

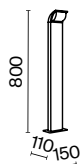

2 ■ **O446WL-L7GF3K**

LED 7W 450lm
 t° 3000K >80Ra 157°
 IP 65

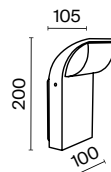

3 ■ **O446WL-L7GF3KSR**

LED 7,5W 450lm
 t° 3000K >80Ra 157°
 IP 44

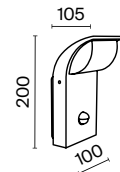



O446WL-L7GF3K

O446FL-L7GF3K

Trim

GF

NEW IP65

EN Aluminum body, shade - graphite. White acrylic diffuser. Light source – lamp with an E27 base. Protection Code – IP65. Ideal illumination for fences and various columns.

DE Aluminiumrahmen, Farbe - Graphit. Weißer Acryl-Diffusor. Lichtquelle - Leuchtmittel mit E27-Fassung. Hoher Schutzgrad - IP65. Ideale Beleuchtung für Zäune und verschiedene Säulen.

IT Corpo in alluminio, il colore è grafite. Il diffusore acrilico bianco. La fonte dell'illuminazione è una lampadina con un portalampada E27. L'alto grado di protezione e' IP65. L'illuminazione perfetta per recinzioni e varie colonne.

FR Corps en aluminium, couleur - graphite. Diffuseur en acrylique blanc. Source de lumière - lampe avec culot E27. Haut degré de protection - IP65. Éclairage parfait pour clôtures et colonnes diverses.



1 ■



2 ■

1 ■ **O455FL-01GF**

💡 1 x E27 15 W
IP 65

2 ■ **O455FL-01GF1**

💡 1 x E27 15 W
IP 65

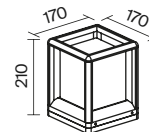
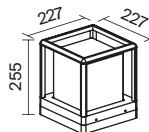



O455FL-01GF

Trupp

GF

NEW

IP54

LED

0

EN Case material – aluminum, shade – graphite. Hidden LED light source - effect of invisible light. Color temperature – 3000K. Suitable for illumination of passageways and entrance areas. Protection Code IP54.

DE Rahmenmaterial - Aluminium, Farbe - Graphit. Versteckte LED-Lichtquelle - Effekt des unsichtbaren Lichts. Farbtemperatur - 3000K. Geeignet für die Beleuchtung von Durchgangs- und Eingangsbereichen. Schutzgrad - IP54.

IT Il materiale del corpo è alluminio, il colore è grafite. Sorgente luminosa a LED nascosta crea un effetto della luce invisibile. La temperatura di colore è 3000K. È adatto per l'illuminazione le aree delle zone di passaggio e di ingresso. Il grado di protezione è IP54.

FR Matériau du corps - aluminium, couleur - graphite. Source de lumière LED cachée - effet de lumière invisible. Température de couleur - 3000K. Convient pour éclairer les zones de passage et d'entrée. Degré de protection - IP54.



1



2

1 ■ **O429WL-L6GF3K**

LED 6W 400lm
 t° 3000K >80Ra 90°
 IP 54

2 ■ **O429WL-L10GF3K**

LED 10W 800lm
 t° 3000K >80Ra 90°
 IP 54

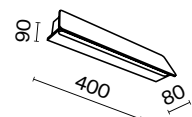
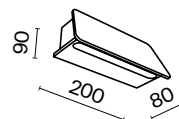



O429WL-L6GF3K

Vint

GF



EN Metallic body, shade - graphite. Patterned glow through the prism of rounded body lines. LED light source, color temperature - 3000K. Wall model can be used as a landscape model. Protection Code – IP65.

DE Metallrahmen, Farbe - Graphit. Gemustertes Leuchten durch das Prisma der Linien des abgerundeten Rahmens. LED-Lichtquelle- Farbtemperatur - 3000K. Das Wandmodell kann als Landschaftsmodell verwendet werden. Hoher Schutzgrad - IP65.

IT Il corpo in metallo, il colore è grafite. Bagliore modellato attraverso il prisma delle linee del corpo arrotondato. Sorgente luminosa a LED, la temperatura di colore e' 3000K. Il modello a parete può essere utilizzato come quello di paesaggio. L'alto grado di protezione e' IP65.

FR Corps en métal, couleur - graphite. Les motifs brillent à travers le prisme des lignes du corps arrondi. Source de lumière LED - température de couleur - 3000K. Le modèle mural peut être utilisé comme modèle paysager. Haut degré de protection - IP65.



1 ■



2 ■

1 ■ **O458FL-L9GF3K**

LED 9W 450lm
t° 3000K >80Ra 117°
IP 65

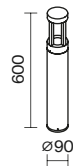

2 ■ **O458WL-L9GF3K**

LED 9W 450lm
t° 3000K >80Ra 117°
IP 65

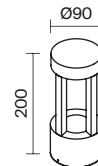



O458FL-L9GF3K

Wald

GF

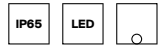

EN Body material - metal, color - graphite. High level of protection against dust and moisture IP65. Resistant to corrosion and temperature extremes. LED light source with a neutral color temperature of 3000K.

DE Rahmenmaterial: Metall, Farbton: Graphit. Hoher Schutzgrad gegen Staub und Feuchtigkeit: IP65. Beständig gegen Korrosion und Temperaturschwankungen. LED-Lichtquelle mit einer neutralen Farbtemperatur von 3000K.

IT Materiale del corpo - metallo, colore - grafite. Alto livello di protezione contro polvere e umidità IP65. Resistente alla corrosione e agli sbalzi di temperatura. Sorgente luminosa a LED con temperatura di colore neutra di 3000K.

FR Matériau du corps : métal, couleur : graphite. Haut niveau de protection contre la poussière et l'humidité IP65. Résistance à la corrosion et aux variations de températures. Source de lumière LED avec une température de couleur neutre de 3000K.



1 ■ **O420FL-L12GF1**

LED 12W 1000lm
t° 3000K >80Ra 54°
IP 65

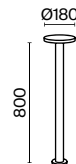

2 ■ **O420FL-L12GF**

LED 12W 1000lm
t° 3000K >80Ra 54°
IP 65

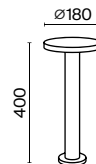



O420FL-L12GF1

Willis

B GR



EN Metal body, shades – grey, black, graphite. Cylinder-shaped dome lamp. IP54 – reliable protection against dust and moisture. Universal diameter is 80 mm.

DE Metallrahmen, Farbtöne: Grau, Schwarz, Graphit. Zylindrischer Lampenschirm. IP54: Zuverlässiger Schutz vor Staub und Feuchtigkeit. Universeller Durchmesser 80 mm.

IT Corpo in metallo, sfumature - grigio, nero, grafite. Plafoniera cilindrica. IP54: protezione sicura contro polvere e umidità. Diametro universale 80 mm.

FR Corps métallique, teinte : gris, noir, graphite. Globe cylindrique. IP54 : protection fiable contre la poussière et l'humidité. Diamètre universel 80 mm.



1 ■ **O418FL-01B**
■ **O418FL-01GR**

💡 1 x E27 60 W
IP 54

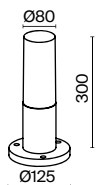

2 ■ **O418FL-01B1**
■ **O418FL-01GR1**

💡 1 x E27 60 W
IP 54

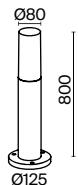

3 ■ **O418WL-01B**
■ **O418WL-01GR**

💡 1 x E27 60 W
IP 54

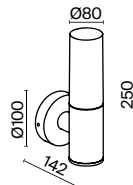

4 ■ **O418CL-01B**
■ **O418CL-01GR**

💡 1 x E27 60 W
IP 54

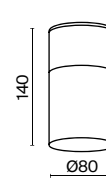



O033WL-L7B3K

O418FL-013K

Zon IP

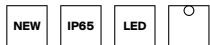

EN Aluminium body. Colors: black, white. White matte diffuser made of high-strength plastic. Two body sizes, two power types. Color temperature: 3000K and 4000K. High degree of protection against dust and moisture

DE Aluminiumgehäuse. Farben: schwarz, weiß. Weiß-matter Diffusor aus hochfestem Kunststoff. Zwei Gehäusegrößen, zwei Leistungsstufen. Farbtemperatur: 3000K und 4000K. Hoher Schutzart vor Staub und Feuchtigkeit.

IT Il corpo e' fatto in alluminio. I colori sono nero, bianco. Il diffusore bianco opaco progettato in plastica ad l'alta resistenza. Le due dimensioni del corpo, i due tipi di una potenza. La temperatura di colore e' 3000K e 4000K. L'alto grado di protezione dalla polvere e dall' umidità

FR Corps en aluminium. Couleurs - noir, blanc. Diffuseur blanc mat en plastique haute résistance. Deux tailles de corps, deux types de puissance. Température de couleur - 3000K et 4000K. Haut degré de protection contre la poussière et l'humidité.



1



2

1 **O431CL-L30B3K**
O431CL-L30W3K

LED 30 W 2200lm
t° 3000K >80Ra 110°
IP 65

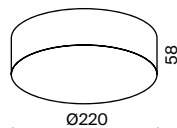

2 **O430CL-L15B3K**
O430CL-L15W3K

LED 15 W 900lm
t° 3000K >80Ra 109°
IP 65

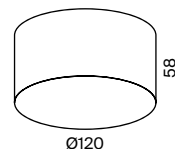

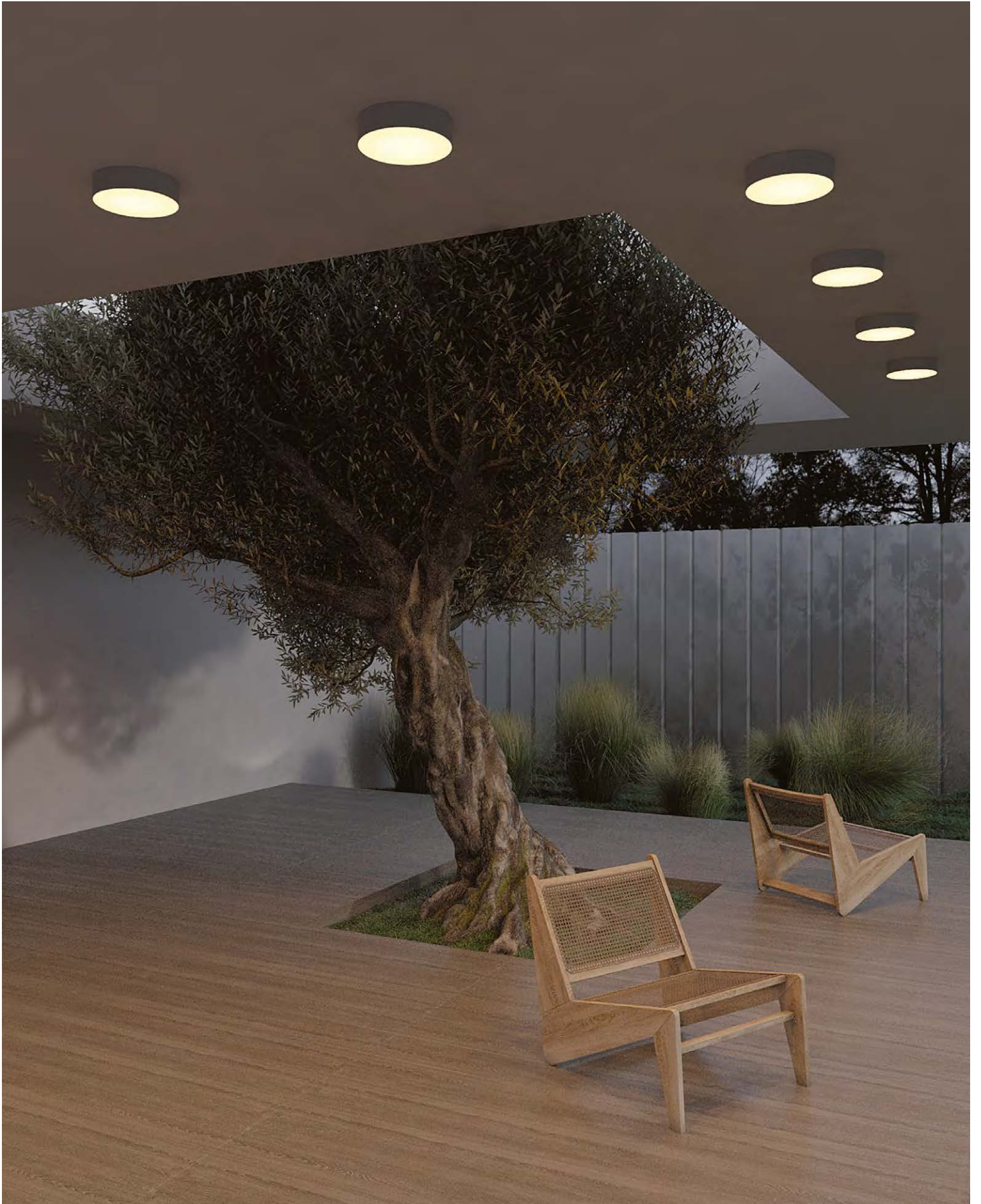

O430CL-L15B3K

Royal Mile

GR



EN Body – cast aluminum, powder coating in grey color. High protection class IP65. LED light source and a driver embedded into the body.

DE Rahmen: Aluminiumguss, pulverbeschichtet in Grau. Hoher Schutzgrad IP65. Die LED-Lichtquelle und der Treiber sind im Rahmen integriert.

IT Corpo in alluminio colato, verniciato a polvere grigio. Elevato grado di protezione IP65. La sorgente luminosa a LED e il driver sono integrati nell'corpo.

FR Corps : aluminium coulé, revêtement par poudre de couleur grise. Haute classe de protection IP65. Source de lumière LED et commande intégrées dans le corps.

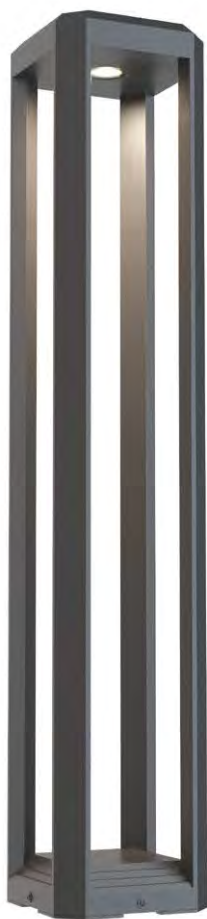

1 ■



2 ■

1 ■ **O019FL-L12GR3K**

LED 13W 680lm
 t° 3000K >80Ra 260°
 IP 65

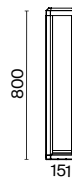

2 ■ **O019FL-L13GR3K**

LED 13W 330lm
 t° 3000K >80Ra 270°
 IP 65

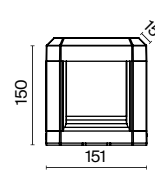



O019FL-L12GR3K

Baker Street

B

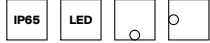

EN Aluminum body, color – black. Double dome lamp made of frosted and transparent glass. High level IP65. LED light source.

DE Aluminiumrahmen, Farbton: Schwarz. Doppelter Lampenschirm aus Milchglas und transparentem Glas. Hoher Schutzgrad IP65. LED-Lichtquelle.

IT Corpo in alluminio, colore - nero. Doppia plafoniera in vetro opaco e trasparente. IP65 di alto livello. Sorgente luminosa a LED.

FR Corps en aluminium, couleur : noir. Globe double en verre transparent et mat. Haut niveau de protection IP65. Source de lumière LED.



1 ■



2 ■

1 ■ **O021FL-L10B3K**

LED 10 W 520lm
 t° 3000K >80Ra 180°
 IP 65

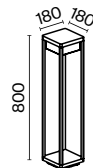

2 ■ **O021WL-L10B4K**

LED 10 W 420lm
 t° 3000K >80Ra 148°
 IP 65

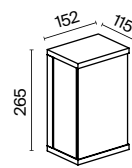



O021WL-L10B4K

Downing Street

EN Aluminum body, color – black. Dome lamp – frosted glass, decorative metal lattice. Light source – SMD-LEDs. High protection class IP65.

DE Aluminiumrahmen, Farbton: Schwarz. Lampenschirm: Milchglas, dekoratives Metallgitter. Lichtquelle: SMD-LEDs. Hoher Schutzgrad IP65.

IT Corpo in alluminio, colore nero. Plafoniera – vetro opaco, griglia metallica decorativa. La sorgente luminosa è LED SMD. Elevato grado di protezione IP65.

FR Corps en aluminium, couleur : noir. Globe : verre mat, grille métallique décorative. Source de lumière : LED SMD. Haute classe de protection IP65.

B

IP65

LED



1 ■

1 ■ **O020WL-L10B4K**

LED 10 W 380lm
 t° 3000K >80Ra 142°
 IP 65

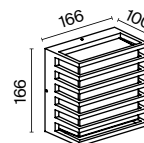

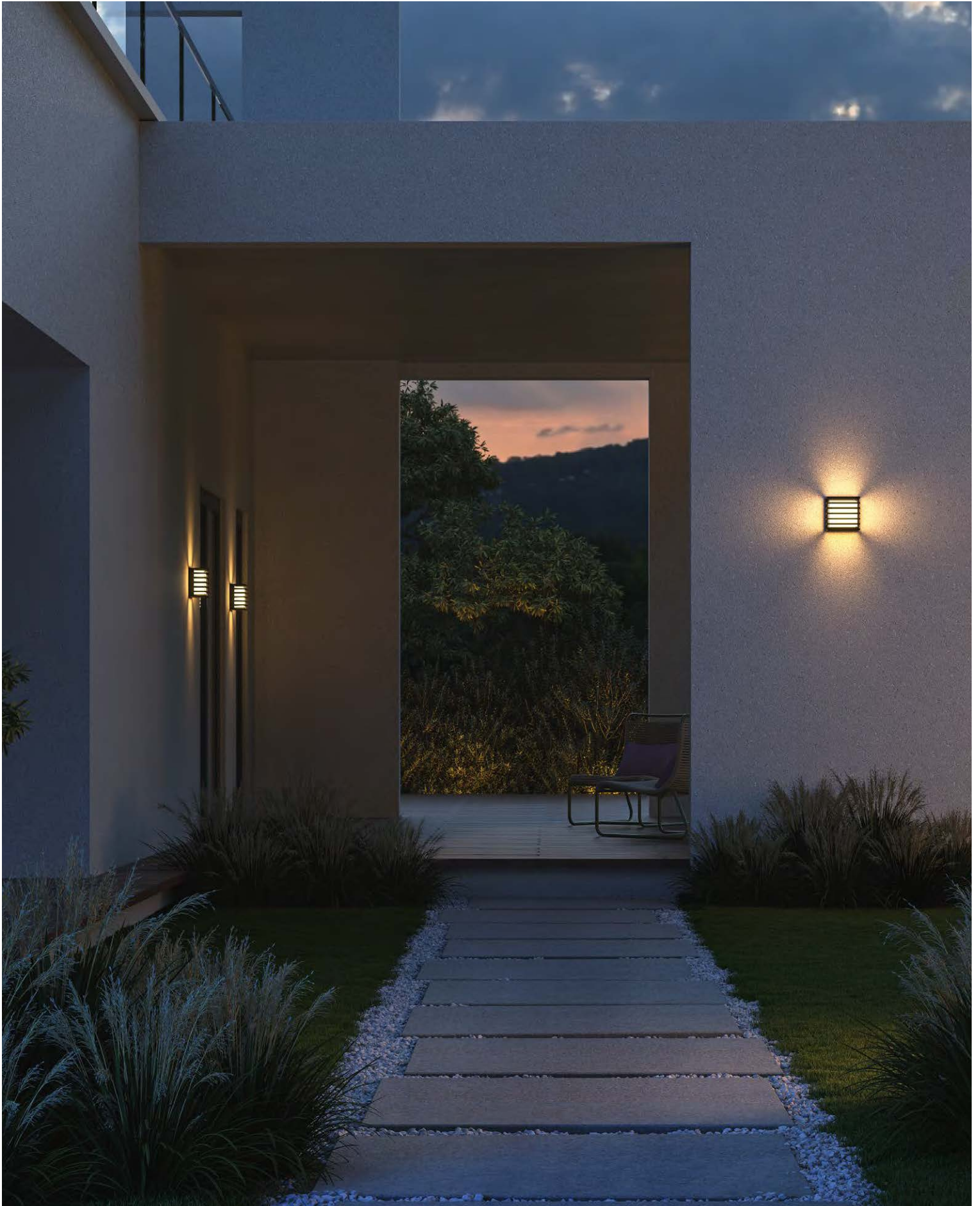

O020WL-L10B4K

Unter den Linden

B

IP54

EN Body – aluminum, color – black. Corrugated texture. Transparent plastic diffusers. Models are equipped with silicone gaskets. High level IP54. Resistant to corrosion and temperature differences.

DE Aluminiumrahmen, Farbton: Schwarz. Geriffelte Textur. Diffusoren aus transparentem Kunststoff. Die Modelle sind mit Silikondichtungen ausgestattet. Hoher Schutzgrad IP54. Beständig gegen Korrosion und Temperaturschwankungen.

IT Corpo - alluminio, colore - nero. Trama ondulata. Diffusori in plastica trasparente. I modelli sono dotati di guarnizioni in silicone. IP54 di alto livello. Resistente alla corrosione e agli sbalzi di temperatura.

FR Corps: aluminium, couleur : noir. Texture en relief. Diffuseurs en plastique transparent. Modèles équipés de joints en silicone. Haut niveau de protection IP54. Résistance à la corrosion et aux changements de températures.



1 ■ **O578FL-01B**

💡 1 × E27 60 W
IP 54

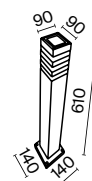

2 ■ **O578WL-02B**

💡 2 × E27 60 W
IP 54

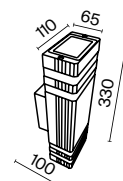



Wall Street

B

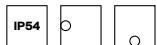

EN Aluminum body, powder coating in black color. Dome lamps rotate – there is an option to change the direction of light. Resistant to corrosion and temperature differences. High level IP54.

DE Aluminiumrahmen, Pulverbeschichtung in Schwarz. Drehbare Lampenschirme: Es besteht die Möglichkeit, die Lichtrichtung zu ändern. Beständig gegen Korrosion und Temperaturschwankungen. Hoher Schutzgrad IP54.

IT Corpo in alluminio, verniciato a polvere nero. Le plafoniere ruotano: è possibile cambiare la direzione della luce. Resistente alla corrosione e agli sbalzi di temperatura. IP54 di alto livello.

FR Corps en aluminium, revêtement par poudre de couleur noire. Globes pivotants: possibilité de modifier l'orientation de la lumière. Résistance à la corrosion et aux changements de températures. Haut niveau de protection IP54.



1 ■



2 ■



3 ■

1 ■ **O010WL-02B**

💡 2 × GU10 50 W
IP 54

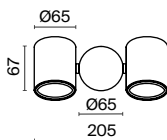

2 ■ **O010FL-01B**

💡 1 × GU10 50 W
IP 54

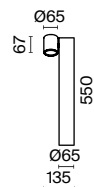

3 ■ **O010FL-02B**

💡 2 × GU10 50 W
IP 54

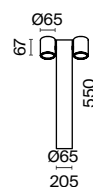



Bowery



EN Metal body, powder coating. Shades – white, gray, black, black with brass. Sealed safety glass. Models with one- and bidirectional light available as part of the series. Ingress Protection Code – IP54. Resistance to corrosion and temperature changes. Light source – lamp with GU10 base.

DE Metallrahmen, Pulverbeschichtung. Farbtöne - Weiß, Grau, Schwarz, Schwarz mit Messing. Versiegeltes Sicherheitsglas. Die Serie umfasst Modelle mit dem Ein- und Zweirichtungslicht. Schutzgrad gegen Staub und Feuchtigkeit - IP54. Korrosions- und Temperaturunterschiedbeständigkeit. Lichtquelle - Leuchtmittel mit GU10-Fassung.

IT Corpo in metallo, la verniciatura a polvere. Le tonalità sono bianco, grigio, nero, nero con ottone. Il vetro e' di protezione sigillato. Nella serie ci sono modelli con le luci unidirezionali e bidirezionali. La protezione dalla polvere e dell'umidità e' IP 54. Resistenza alla corrosione e agli sbalzi delle temperature. La fonte dell'illuminazione è una lampadina con un portalampada GU10.

FR Corps en métal, revêtement en poudre. Teintes - blanc, gris, noir, noir laiton. Verre de protection hermétique. La série comprend des modèles avec lumière unidirectionnelle et bidirectionnelle. Protection contre la poussière et l'humidité - IP54. Résistance à la corrosion et aux différences de température. Source de lumière - lampe avec culot GU10.



1 ■ □



2 ■ □



3 ■ ■



4 ■ ■ □



5 ■ ■ □

1 ■ **O583WL-01B**
□ **O583WL-01W**

💡 1 × GU10 60 W
IP 54

2 ■ **O583WL-02B**
□ **O583WL-02W**

💡 2 × GU10 60 W
IP 54

3 ■ **O582WL-02B**
■ **O582WL-02BS**

💡 2 × GU10 60 W
IP 54

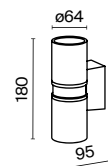
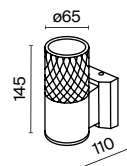
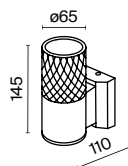



O574WL-02GR

- 4 ■ **O574WL-01B**
 ■ **O574WL-01GR**
 ■ **O574WL-01W**

💡 1 × GU10 50 W
 IP 54

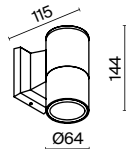

- 5 ■ **O574WL-02B**
 ■ **O574WL-02GR**
 ■ **O574WL-02W**

💡 2 × GU10 50 W
 IP 54

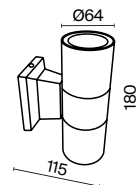

Bronx

B GR

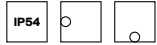

EN Aluminum body in two colors: grey and black. Plastic dome lamp. Anti-glare lattice. High level IP54. Resistant to corrosion and temperature differences. Light source – lamp with E27 base.

DE Aluminiumrahmen in zwei Farbtönen: Grau und Schwarz. Lampenschirme aus Kunststoff. Antireflexgitter. Hoher Schutzgrad IP54. Beständig gegen Korrosion und Temperaturschwankungen. Lichtquelle: Leuchtmittel mit E27-Fassung.

IT Corpo in alluminio in due tonalità: grigio e nero. Plafoniere in plastica. Griglia antiriflesso. IP54 di alto livello. Resistente alla corrosione e agli sbalzi di temperatura. La sorgente luminosa è una lampadina con attacco E27.

FR Corps en aluminium en deux teintes : gris et noir. Globe en plastique. Grille anti-éblouissement. Haut niveau de protection IP54. Résistance à la corrosion et aux changements de températures. Source de lumière : ampoule à culot E27.



1 ■ **O576WL-02B**
■ **O576WL-02GR**

💡 2 × E27 60 W
IP 54

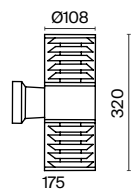

2 ■ **O576WL-01B**
■ **O576WL-01GR**

💡 1 × E27 60 W
IP 54

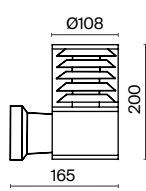

3 ■ **O576FL-01B1**
■ **O576FL-01GR1**

💡 1 × E27 60 W
IP 54

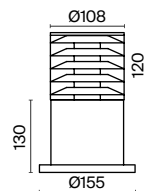

4 ■ **O576FL-01B**
■ **O576FL-01GR**

💡 1 × E27 60 W
IP 54

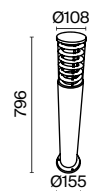



Mezzo



EN A series of surface-mounted LED luminaires for illuminating steps or paths. Black and white colours. It is supplied complete with a driver and an installation cup.

DE Eine Reihe von LED-Aufsetzleuchten zur Beleuchtung von Stufen oder Wegmarkierungen. Schwarze und weiße Farbe. Inklusive Treiber und Installationsbecher.

IT Una serie di lampade LED sovrapposte per l'illuminazione delle scale o sentieri. I colori nero e bianco. Dotate da un driver e un supporto da montaggio.

FR Une série des luminaires LED appliqués pour l'illumination des marches de l'escalier et des sentiers. Couleur blanche et noire. Kit - pilote et un verre pour installer un luminaire.



1 **O033WL-L3W3K**

LED 4,6W 385lm
t° 3000K >80Ra 120°
IP 54

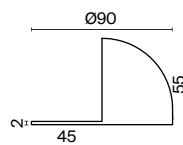

2 **O033WL-L7B3K**

LED 7,4W 513lm
t° 3000K >80Ra 120°
IP 54

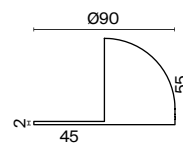



O033WL-L7B3K

O033WL-L3W3K

Scope

B



EN Aluminum body in black color. The direction of the light is adjustable in the horizontal and vertical plane. High protection class IP65. Resistant to corrosion and temperature differences. It is completed with pegs for installation in the ground and a terminal block.

DE Aluminiumrahmen in Schwarz. Die Lichtrichtung ist in horizontaler und vertikaler Ebene einstellbar. Hoher Schutzgrad IP65. Beständig gegen Korrosion und Temperaturschwankungen. Im Lieferumfang enthalten ist ein Pflock für den Einbau in den Boden und eine Klemmleiste.

IT Corpo in alluminio nero. La direzione della luce è regolabile sul piano orizzontale e verticale. Elevato grado di protezione IP65. Resistente alla corrosione e agli sbalzi di temperatura. Piolo per l'installazione nel suolo e morsetteria inclusi.

FR Corps en aluminium de couleur noire. Orientation de la lumière sur les plans horizontal et vertical. Haute classe de protection IP65. Résistance à la corrosion et aux changements de températures. Kit de fixation au sol et bornier inclus.

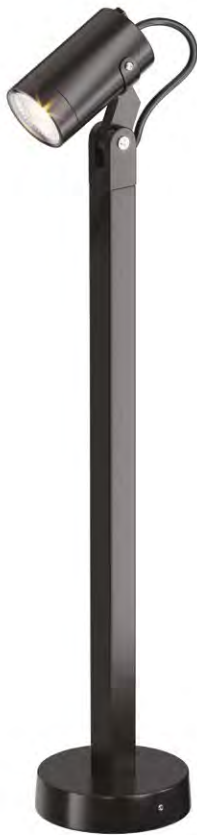

1 ■



2 ■



3 ■

1 ■ **O025FL-01B1**

💡 1 x GU10 50 W
IP 65

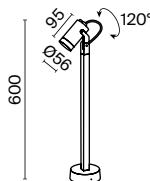

2 ■ **O025WL-01B**

💡 1 x GU10 50 W
IP 65

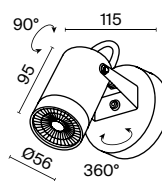

3 ■ **O025FL-01B**

💡 1 x GU10 20 W
IP 65

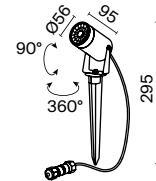



O025FL-01B1

O025WL-01B

O025FL-01B

Bold

B GR

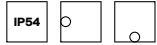

EN "Bold" series lamps designed for outdoor lighting of a suburban area and the adjoining territory. The series includes wall, landscape and wall-floor models that make it possible to implement illumination of entire territory in a single style. Light source – replaceable lamp with E27 base. These lamps with a spherical dome lamp will perfectly complement any exterior.

DE Die Leuchten der Serie Bold sind für die Außenbeleuchtung des Landgrundstücks und der am Haus gelegenen Fläche bestimmt. Die Serie umfasst Wand-, Landschaftsmodelle sowie Wand- und Bodenmodelle, die es ermöglichen, die gesamte Fläche in einem einheitlichen Stil zu beleuchten. Lichtquelle: Ein auswechselbares Leuchtmittel mit E27-Fassung. Leuchten mit kugelförmigen Lampenschirmen ergänzen jede Außenarchitektur perfekt.

IT Le lampade Bold sono progettate per l'illuminazione da esterno in campagna e dell'area pertinente. La serie comprende modelli da parete, da esterno e parete-terra, che consentono di implementare l'illuminazione dell'intero territorio in un unico stile. La sorgente luminosa è una lampadina sostituibile con attacco E27. Le lampade con plafoniere sferiche completano perfettamente qualsiasi esterno.

FR Luminaire Bold destinés à l'éclairage extérieur d'un terrain en campagne et du territoire attenant à la maison. La série comprend des modèles muraux, paysagers et muraux-lampadaires, ce qui permet de réaliser l'éclairage de l'ensemble du territoire dans un style uni. Source de lumière : ampoule amovible à culot E27. Les luminaires à globe sphérique compléteront parfaitement tout extérieur.



1 ■ **O598FL-01B**
■ **O598FL-01GR**

💡 1 x E27 60 W
IP 54

2 ■ **O598WL-01B1**
■ **O598WL-01GR1**

💡 1 x E27 60 W
IP 54

3 ■ **O598WL-01B**
■ **O598WL-01GR**

💡 1 x E27 60 W
IP 54

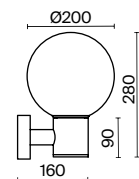
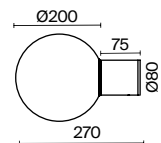
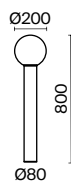



O598FL-01B

O598WL-01B

Ares

GF

IP54

LED



EN "Ares" ceiling lamps with a high level of protection IP54 designed for the main lighting of rooms with high humidity and outdoor lighting of terraces, arbors, walk-through areas. The luminaires of this series include two power options: 8W and 10W that makes it possible to choose model for any needs. Minimalistic design and graphite shade are ideal for modern interiors and exteriors.

DE Le lampade da soffitto Ares con un alto grado di protezione IP54 sono progettate per l'illuminazione principale di ambienti con elevata umidità e l'illuminazione da esterno di terrazze, gazebo, aree di passaggio. Le lampade della serie sono presentate in due opzioni di potenza: 8W e 10W, cosa che consente di scegliere un modello per qualsiasi esigenza. Il design minimalista e la tonalità grafite sono ideali per interni ed esterni moderni.

IT Le lampade da soffitto Ares con un alto grado di protezione IP54 sono progettate per l'illuminazione principale di ambienti con elevata umidità e l'illuminazione da esterno di terrazze, gazebo, aree di passaggio. Le lampade della serie sono presentate in due opzioni di potenza: 8W e 10W, cosa che consente di scegliere un modello per qualsiasi esigenza. Il design minimalista e la tonalità grafite sono ideali per interni ed esterni moderni.

FR Plafonniers Ares avec un haut niveau de protection IP54 destinés à l'éclairage principal des locaux avec un fort taux d'humidité et l'éclairage extérieur des terrasses, pergolas, zones de passage. Les luminaires de la série sont proposés en deux variantes de puissance : 8W et 10W, ce qui permet de choisir un modèle selon n'importe quel besoin. Le design minimaliste et la teinte graphite conviennent parfaitement pour les intérieurs et les extérieurs de style moderne.



1



2

1 ■ **O309CL-L10GF3K**

LED 10W 700lm
 t° 3000K >80Ra 36°
 IP 54

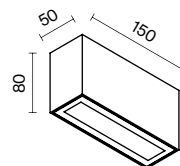
2 ■ **O309CL-L8GF3K**

LED 8W 500lm
 t° 3000K >80Ra 40°
 IP 54

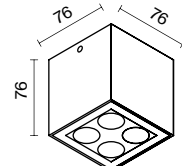

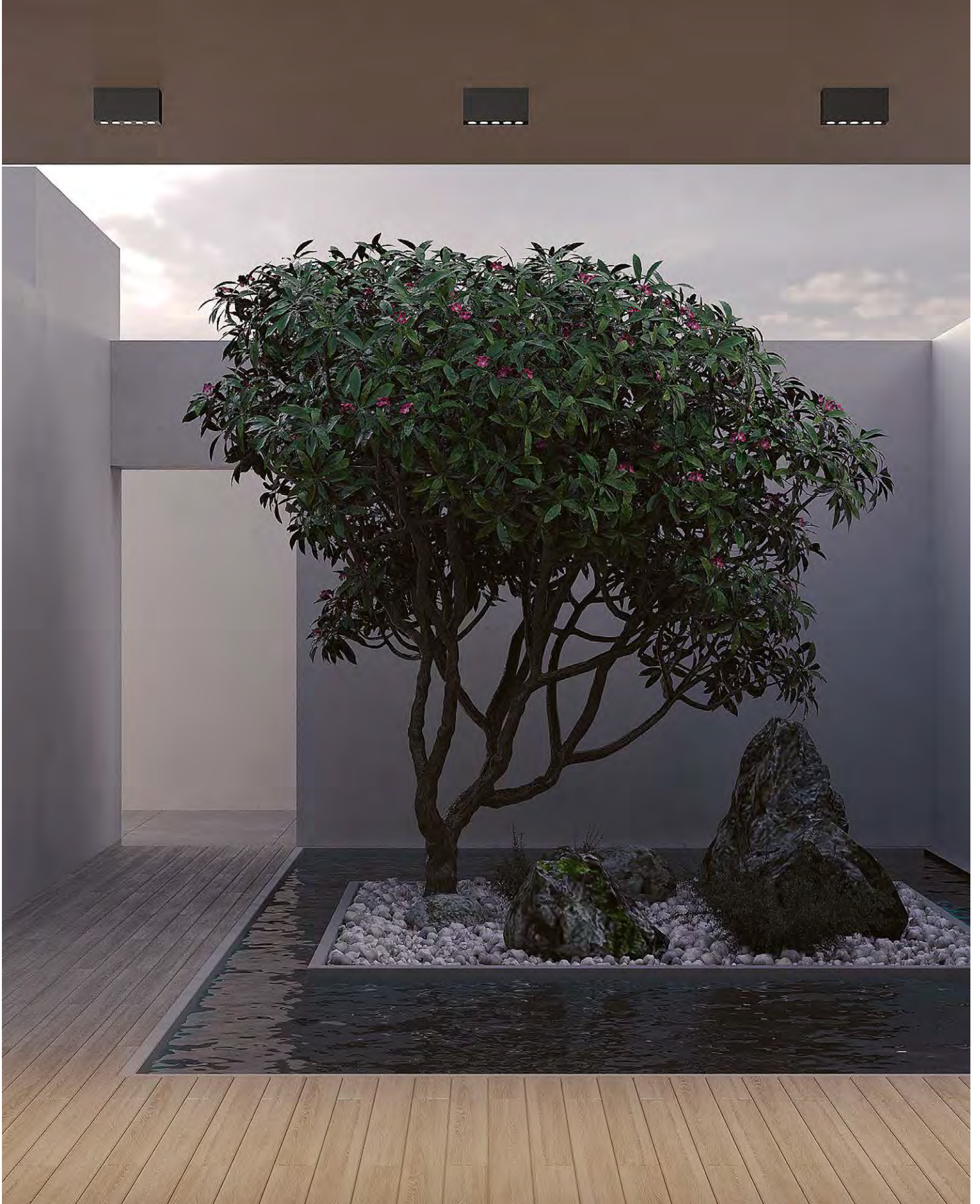

O309CL-L8GF3K

SPECTACULAR MOMENTS OF OUTDOOR LIGHTING

Permit me to extend my salutations; I am a luminaire crafted from noble aluminum, adorned in an enigmatic graphite attire. My silhouette is an embodiment of artistry, characterized by straight lines and graceful contours. I am a conduit of light, its trajectory singular, crafting an entrancing ambiance.

I coexist harmoniously with an LED light source; together, we are a formidable union, diligently serving our owners for an extended duration, all the while remaining unobtrusive.

I am versatile in my installation, capable of being embedded in the ground or onto sturdy concrete surfaces, adapting seamlessly to diverse environmental conditions.

I find utility both as primary and secondary illumination, transforming the nocturnal landscape into a warm adventure. In this world of light and mystique, I stand as your unwavering companion, facilitating joyous and soulful conversations under the shroud of night.



Pole

GF

NEW IP65 LED

EN Case material – aluminum, shade – graphite. Rectangular elongated silhouette with a strip of light in one direction. LED light source. Color temperature – 3000K. Could be installed in both ground and hard concrete surfaces. Power connector provided. Models included in the series are suitable for main and supplementary lighting. Protection Code IP54.

DE Rahmenmaterial - Aluminium, Farbe - Graphit. Rechteckige langgestreckte Silhouette mit einem Lichtstreifen in eine Richtung. LED-Lichtquelle. Farbtemperatur 3000K. Einbaumöglichkeit sowohl in die Boden- als auch in die starre Betonoberfläche Steckverbinder im Lieferumfang enthalten. Die Serie ist für Grund- und Zusatzbeleuchtung geeignet. Schutzgrad - IP54.

IT Il materiale del corpo è alluminio, il colore è grafite. La silhouette allungata rettangolare con una striscia di luce su un lato. Sorgente luminosa a LED. La temperatura di colore è 3000K. E' la possibilità di installazione sulla superficie in terra sia in superficie in calcestruzzo duro. E' incluso il connettore di connessione. La serie delle lampade è adatta per l'illuminazione principale e secondaria. Il grado di protezione è IP54.

FR Matériau du corps - aluminium, couleur - graphite. Une silhouette rectangulaire allongée avec une bande de lumière dans une direction. Source de lumière LED. Température de couleur 3000K. Possibilité d'installation aussi bien dans le sol que sur des surfaces en béton dur. Un connecteur de connexion est inclus. La série convient à l'éclairage principal et supplémentaire. Degré de protection - IP54.



1 ■ **O440FL-L24GF3K**

LED 24W 1200lm
t° 3000K >80Ra 120°
IP 65

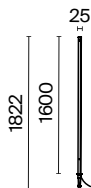

2 ■ **O440FL-L18GF3K**

LED 18W 950lm
t° 3000K >80Ra 120°
IP 65

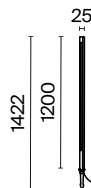

3 ■ **O440FL-L12GF3K**

LED 12W 650lm
t° 3000K >80Ra 120°
IP 65

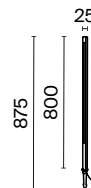



O440FL-L12GF3K

O440FL-L24GF3K

O440FL-L18GF3K

Spin

GF W

NEW IP54 LED

EN Body material: metal, diffuser material: glass. Shades: graphite, white. Rotating luminous element for 360° light direction adjustment. High degree of protection: IP 54. LED light source, color temperature: 3000K. Color rendering index: 80Ra.

DE Metallgehäuse, Glasdiffusor. Farbtöne: Graphit, weiß. Drehbares Lichtelement zur 360°-Einstellung der Lichtrichtung. Hoher Schutzart: IP 54. LED-Lichtquelle, Farbtemperatur - 3000K. Farbwiedergabeindex: 80Ra.

IT Il materiale del corpo è il metallo, il materiale del diffusore è un vetro. Le tonalita' sono grafite, bianco. Un elemento luminoso rotante per regolazione della direzione della luce a 360°. L'alto grado di protezione e' IP 54. La sorgente luminosa a LED, la temperatura di colore e' 3000K. L'indice di resa cromatica e' 80Ra.

FR Matériau du corps - métal, matériau du diffuseur - verre. Abat-jour - graphite, blanc. Élément lumineux rotatif à régler la direction de la lumière à 360°. Degré de protection élevé - IP 54. Source de lumière LED, température de couleur - 3000K. Indice de rendu des couleurs - 80Ra.



1 ■ ■



2 ■ ■

1 ■ **O310CL-L5GF3K**
 □ **O310CL-L5W3K**

LED 7W 650lm
t° 3000K >80Ra 155°
IP 54

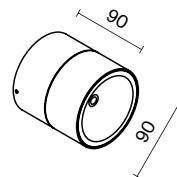

2 ■ **O310CL-L12GF3K**
 □ **O310CL-L12W3K**

LED 12W 1050lm
t° 3000K >80Ra 155°
IP 54

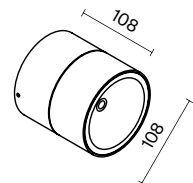



Shim

GF W

IP65 LED

EN "Shim" series of wall lamps designed for architectural lighting of the buildings. The range includes models with one and two-way light beams, as well as lamps with a high power of 24W for high-quality and bright lighting of both private and commercial buildings. Color scores: graphite and white. Color temperature of 3000K is optimal for outdoor lighting.

DE Serie von Wandleuchten Shim zur Architekturbeleuchtung von Gebäuden. Das Sortiment umfasst Modelle mit ein- und zweiseitigen Lichtbündeln sowie Leuchten mit hoher Leistung von 24 W für hochwertige und helle Beleuchtung nicht nur für private, sondern auch für gewerbliche Gebäude. Farbtöne: Graphit und Weiß. Die Farbtemperatur von 3000K ist für Außenbeleuchtung optimal.

IT Serie di lampade da parete Shim per l'illuminazione architettonica di edifici. La gamma comprende modelli con un fascio di luce in una e due direzioni, nonché lampade con un'elevata potenza di 24 W per un'illuminazione vivida e di alta qualità non solo di edifici privati, ma anche quelli commerciali. Colori: grafite e bianco. La temperatura di colore di 3000K è ottimale per l'illuminazione da esterno.

FR Série d'appliques murales Shim pour l'éclairage architectural des bâtiments. L'assortiment propose des modèles avec un faisceau de lumière dans une ou deux directions, ainsi que des luminaires de haute puissance 24W pour un éclairage de qualité et intense non seulement des bâtiments privés, mais aussi commerciaux. Choix de couleurs : graphite et blanc. Température de couleur de 3000K optimale pour un éclairage extérieur.



1 ■ **O303WL-L10GF3K**
□ **O303WL-L10W3K**

LED 10W 800lm
t° 3000K >80Ra 145°
IP 65

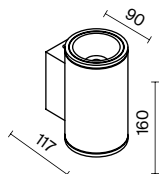

2 ■ **O303WL-L24GF3K**
□ **O303WL-L24W3K**

LED 24W 1700lm
t° 3000K >80Ra 145°
IP 65

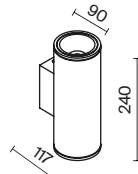

3 ■ **O303WL-L5GF3K**
□ **O303WL-L5W3K**

LED 5W 350lm
t° 3000K >80Ra 75°
IP 65

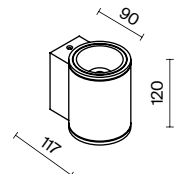



O303WL-L24W3K

Spear

GF

NEW IP65 LED

EN Metallic body, shade - graphite. White acrylic diffuser. Narrow cylindrical lamp for illuminating plantings - flowers, shrubs, trees, lawns. Ground installation. Multiple lamps can be connected to a single power source. LED light source, color temperature - 3000K. Protection Code IP54. Power supply - 24V.

DE Metallrahmen, Farbe - Graphit. Weißer Acryl-Diffusor. Schmale zylindrische Leuchte für die Beleuchtung von Pflanzenanlagen - Blumen, Sträuchern, Bäumen, Rasen. Einbau in den Boden. Möglichkeit, mehrere Leuchten an eine Speisequelle anzuschließen. LED-Lichtquelle, Farbtemperatur - 3000K. Schutzgrad - IP54. Spannung 24V.

IT Il corpo in metallo, il colore è grafite. Il diffusore acrilico bianco. La lampada cilindrica stretta per l'illuminazione di piantagioni vegetali - delle fiori, degli arbusti, alberi, prati. E' prevista l'installazione nel terreno. E' possibile di collegare qualche lampada ad una singola fonte di alimentazione. Sorgente luminosa a LED, la temperatura di colore e' 3000K. Il grado di protezione e' IP54. L'alimentazione e' 24V.

FR Corps en métal, couleur - graphite. Diffuseur en acrylique blanc. Une lampe cylindrique étroite pour éclairer les plantations - fleurs, arbustes, arbres, pelouses. Installation dans le sol. Possibilité de connecter plusieurs lampes à une seule source d'alimentation. Source de lumière LED, température de couleur - 3000K. Degré de protection - IP54. Alimentation 24V.

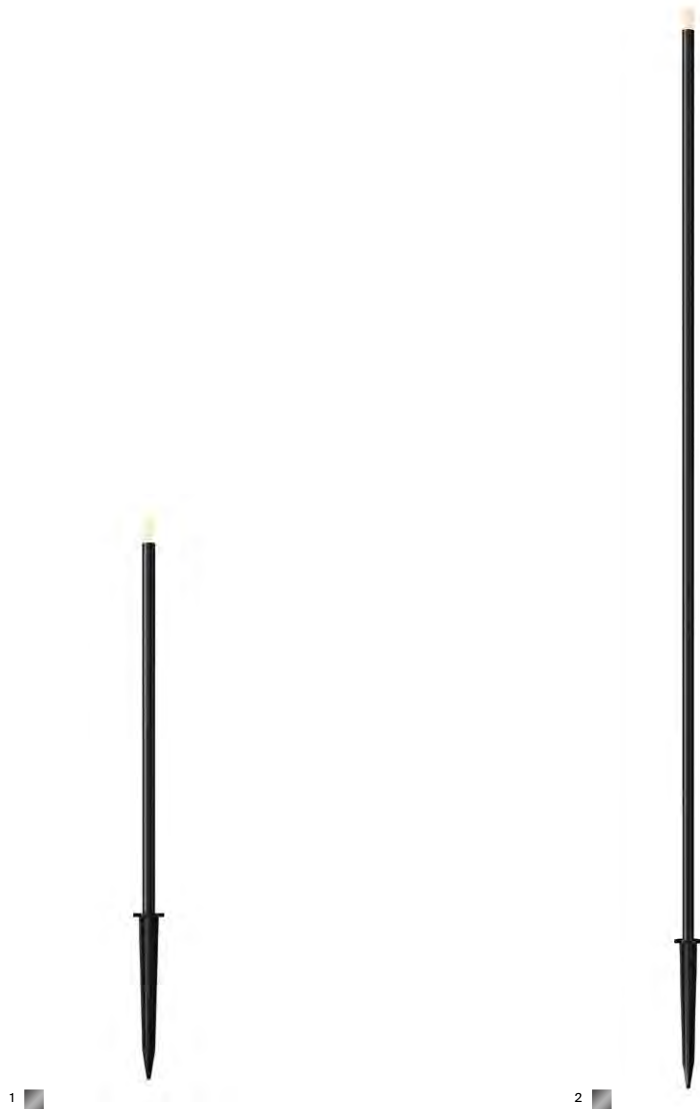

1 ■ **O441FL-L1GF3K**

LED 1W 50lm
 t° 3000K >80Ra 350°
 IP 65



2 ■ **O441FL-L1GF3K1**

LED 1W 50lm
 t° 3000K >80Ra 350°
 IP 65



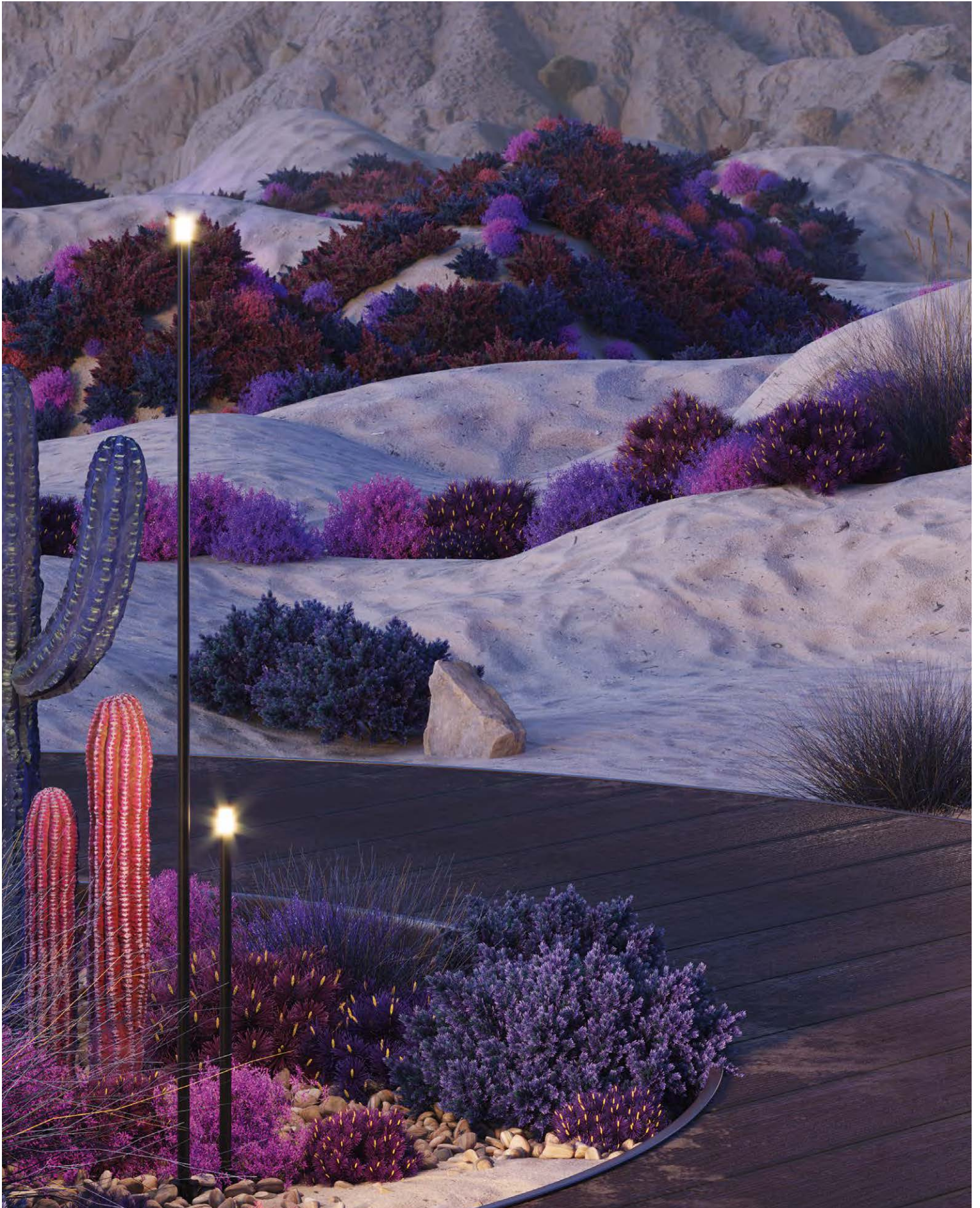

LIGHTING FOR WALLS



STEPS AND PATHS

Bil

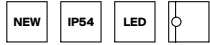

EN "Bil" series lamps designed to illuminate passage areas, flights of stairs and corridors. High level of protection IP54 makes it possible to use the series both indoors and in rooms with high humidity, outdoors. The lamps are designed in two classic colors: white and black, which allow choosing a model for most interiors and exteriors. Wide beam angle provides a large area of illumination.

DE Die Leuchten der Serie Bil sind für die Beleuchtung von Durchgängen, Treppenhäusern und Korridoren konzipiert. Der hohe Schutzgrad IP54 ermöglicht den Einsatz der Serie sowohl im Innen- als auch im Außenbereich sowie in Feuchträumen. Die Leuchten sind in zwei klassischen Farbtönen erhältlich: Weiß und Schwarz, die zu den meisten Innen- und Außeneinrichtungen passen. Der breite Leuchtwinkel sorgt für eine große Beleuchtungsfläche.

IT Gli apparecchi della serie Bil sono progettati per illuminare aree di passaggio, rampe di scale e corridoi. L'alto grado di protezione IP54 permette di utilizzare la serie sia all'interno che in ambienti con elevata umidità, all'esterno. Gli apparecchi sono presentati in due tonalità classiche: bianco e nero, che consente di scegliere un modello per la maggior parte degli interni e degli esterni. L'ampio angolo del fascio fornisce un'estesa area di illuminazione.

FR Luminaires de la série Bil pour l'éclairage des zones de passage, des volées d'escalier et des couloirs. Le haut niveau de protection IP54 donne la possibilité d'utiliser la série aussi bien à l'intérieur d'un local que dans des locaux à fort taux d'humidité, en extérieur. Les luminaires sont proposés en deux teintes classiques : blanc et noir, ce qui permet de choisir un modèle pour la plupart des intérieurs et extérieurs. Le large angle du flux lumineux permet d'éclairer une grande surface.



1 ■ □

1 ■ **O015SL-L3B3K**
□ **O015SL-L3W3K**

LED 3W 60lm
t° 3000K >80Ra 30°
IP 54

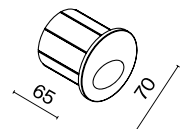

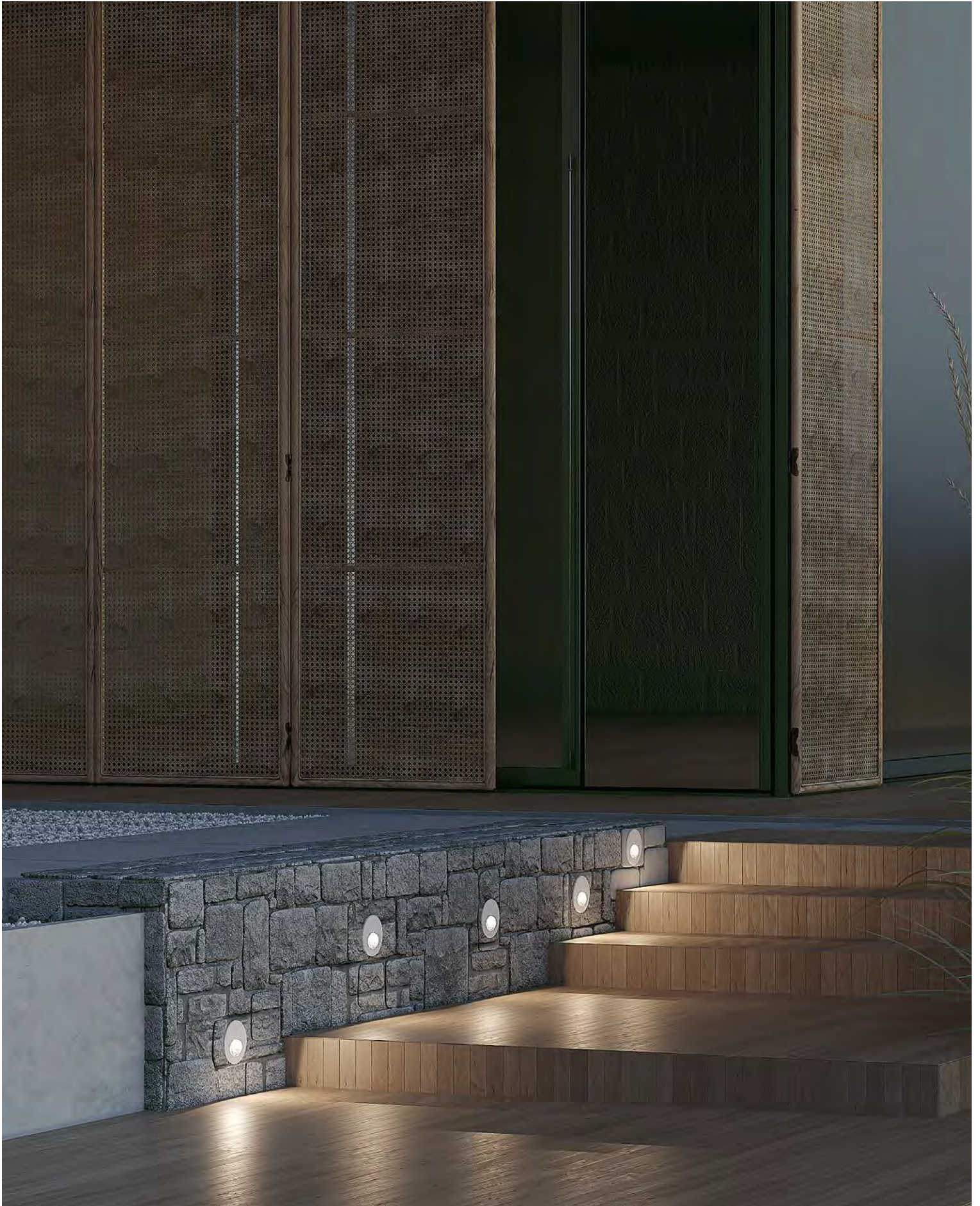

O015SL-L3W3K

Biscotti

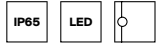

EN A series of lamps designed to illuminate paths, stairs and other spaces. Aluminum body, shades – white, black. High level IP65. Protection against external mechanical influences IK08. Models for 1 and 4 light beams. It is possible to install lamps on the wall and floor.

DE Eine Serie der Leuchten zur Beleuchtung von Wegen, Treppen und anderen Räumen. Aluminiumrahmen, Farbtöne: Weiß, Schwarz. Hoher Schutzgrad IP65. Schutz vor äußeren mechanischen Einflüssen IK08. Modelle mit 1 und 4 Lichtbündeln. Kann in Wand und in Boden eingebaut werden.

IT Una serie di apparecchi per l'illuminazione di sentieri, scale e altri spazi. Corpo in alluminio, tonalità – bianco, nero. IP65 di alto livello. Protezione dagli impatti meccanici esterni IK08. Modelli per 1 e 4 fasci di luce. Possibilità di installazione a parete e pavimento.

FR Série de luminaires pour l'éclairage des allées, escaliers et autres espaces. Corps en aluminium, teintes : blanc, noir. Haut niveau de protection IP65. Protection contre les effets mécaniques externes IK08. Modèles à 1 et 4 faisceaux lumineux. Encastrement possible dans le mur et le sol.



1 ■



2 ■ □

1 ■ **O036-L3B3K**

LED 3W 60lm
 t° 3000K >80Ra 165°
 IP 65

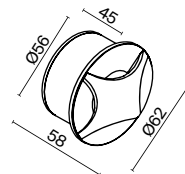

2 ■ **O035-L3B3K**
 □ **O035-L3W3K**

LED 3W 30lm
 t° 3000K >80Ra 36°
 IP 65

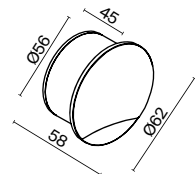



Bosca

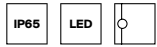

EN "Bosca" series lamps designed to illuminate passage areas, flights of stairs and corridors. High level of protection IP65 makes it possible to use the series both indoors and in rooms with high humidity, outdoors. The lamps are designed in two classic colors: white and black, as well as in two power options: 3W and 5W. The lamp versatility makes it possible to choose the model for any task. Wide beam angle provides a large area of illumination.

DE Die Leuchten der Serie Bosca sind für die Beleuchtung von Durchgängen, Treppenhäusern und Korridoren konzipiert. Der hohe Schutzgrad IP65 ermöglicht den Einsatz der Serie sowohl im Innen- als auch im Außenbereich sowie in Feuchträumen. Die Leuchten sind in zwei klassischen Farbtönen erhältlich: Weiß und Schwarz, sowie in zwei Leistungsvarianten: 3W und 5W. Die Vielfalt des Angebots ermöglicht es, ein Modell für jeden Bedarf zu wählen. Der breite Leuchtwinkel sorgt für eine große Beleuchtungsfläche.

IT Gli apparecchi della serie Bosca sono progettati per illuminare zone di passaggio, rampe di scale e corridoi. L'alto grado di protezione IP65 permette di utilizzare la serie sia all'interno che in ambienti con elevata umidità, all'esterno. Gli apparecchi sono presentati in due tonalità classiche: bianco e nero, nonché in due opzioni di potenza: 3W e 5W. Una varietà di assortimento consente di scegliere un modello per qualsiasi attività. L'ampio angolo del fascio fornisce un'estesa area di illuminazione.

FR Les luminaires de la série Bosca sont destinés à l'éclairage des zones de passage, des volées d'escalier et des couloirs. Le haut niveau de protection IP65 donne la possibilité d'utiliser la série aussi bien à l'intérieur d'un local que dans des locaux à fort taux d'humidité, en extérieur. Les luminaires sont proposés en deux teintes classiques: blanc et noir, et également en deux variantes de puissance : 3W et 5W. L'assortiment varié permet de choisir un modèle pour n'importe quel objectif. Le large angle du flux lumineux permet d'éclairer une grande surface.



1 ■ □



2 ■ □

1 ■ **O045SL-L3B3K**
□ **O045SL-L3W3K**

LED 3W 250lm
t° 3000K >80Ra 65°
IP 65

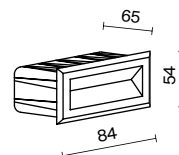

2 ■ **O045SL-L5B3K**
□ **O045SL-L5W3K**

LED 5W 400lm
t° 3000K >80Ra 60°
IP 65

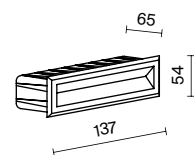



Limo



EN Recessed luminaire designed to illuminate paths, stairs and other spaces. Aluminum body, shades – black and white. High level IP65. Protection against external mechanical influences IK08.

DE Einbauleuchte zur Beleuchtung von Wegen, Treppen und anderen Räumen. Aluminiumrahmen, Farbtöne: Schwarz und Weiß. Hoher Schutzgrad IP65. Schutz vor äußeren mechanischen Einflüssen IK08.

IT Apparecchio da incasso per l'illuminazione di sentieri, scale e altri ambienti. Corpo in alluminio, tonalità - bianco e nero. IP65 di alto livello. Protezione dagli impatti meccanici esterni IK08.

FR Luminaire encastrable pour l'éclairage des allées, escaliers et autres espaces. Corps en aluminium, teintes : noir et blanc. Haut niveau de protection IP65. Protection contre les effets mécaniques externes IK08.



1 ■ □

1 ■ **O037-L3B3K**
□ **O037-L3W3K**

LED 3W 120lm
t° 3000K >80Ra 72°
IP 65

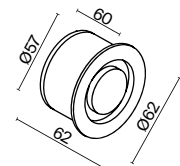



Lock

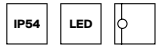

EN "Lock" series lamps designed to illuminate stairs are ideal for marker lighting of walkways, stairwells and corridors. High level of protection IP54 makes it possible to use the series both indoors and in rooms with high humidity, outdoors. The lamps are designed in two classic colors: white and black, which allow choosing a model for most interiors and exteriors.

DE Die Treppenhauseuchten der Serie Lock sind ideal für die Markierungsbeleuchtung in Durchgängen, Treppenhäusern und Fluren. Der hohe Schutzgrad IP54 ermöglicht den Einsatz der Serie sowohl im Innen- als auch im Außenbereich sowie in Feuchträumen. Die Leuchten sind in zwei klassischen Farbtönen erhältlich: Weiß und Schwarz, die zu den meisten Innen- und Außeneinrichtungen passen.

IT Le lampade per scale della serie Lock sono ideali per l'illuminazione d'area di passerelle, vani scala e corridoi. L'alto grado di protezione IP54 permette di utilizzare la serie sia all'interno che in ambienti con elevata umidità, all'esterno. Le lampade sono presentate in due tonalità classiche: bianco e nero, cosa che consente di scegliere un modello per la maggior parte degli interni e degli esterni.

FR Les luminaires pour l'éclairage des escaliers de la série Lock conviennent idéalement pour le marquage lumineux des zones de passage, les volées d'escalier et les couloirs. Le haut niveau de protection IP54 donne la possibilité d'utiliser la série aussi bien à l'intérieur d'un local que dans des locaux à fort taux d'humidité, en extérieur. Les luminaires sont proposés en deux teintes classiques : blanc et noir, ce qui permet de choisir un modèle pour la plupart des intérieurs et extérieurs.



1 ■ □

1 ■ **O014SL-L3B3K**
□ **O014SL-L3W3K**

LED 3W 10lm
t° 3000K >80Ra 30°
IP 54

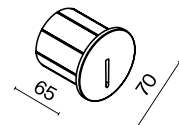

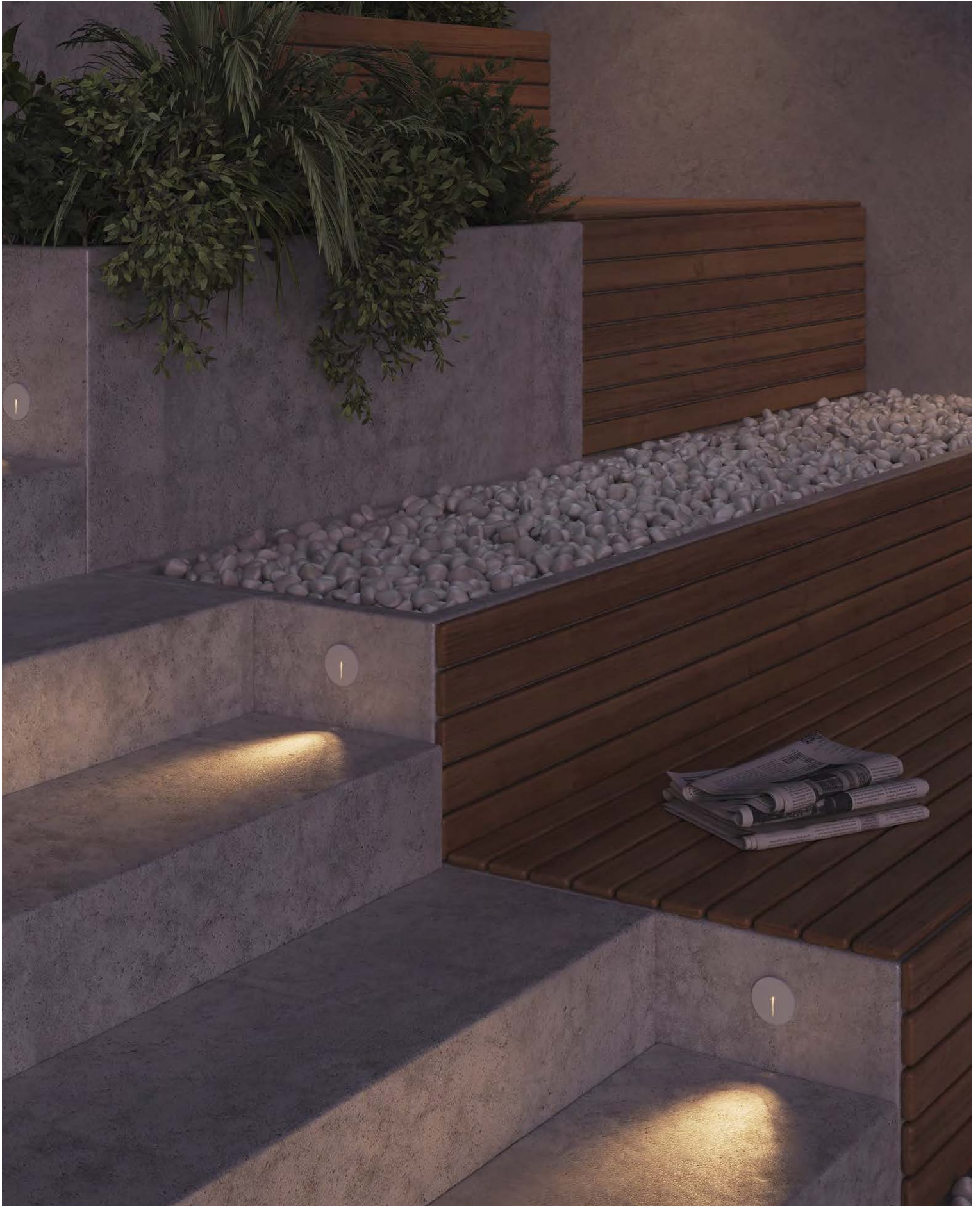

Mane

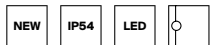

EN Aluminium body. Color: black, white. High-strength plastic diffuser. LED light source. Color temperature: 3000K. High degree of protection: IP54.

DE Aluminiumgehäuse. Farben: schwarz, weiß. Diffusor aus hochfestem Kunststoff. LED-Lichtquelle, Farbtemperatur - 3000K. Hoher Schutzart: IP54

IT Il corpo e' fatto in alluminio. I colori sono nero, bianco. Il diffusore e' fatto in plastica ad alto consumo. La sorgente luminosa a LED. La temperatura di colore e' 3000K. L'alto grado di protezione e' IP54.

FR Corps en aluminium. Couleur - noir, blanc. Diffuseur en plastique haute résistance. Source de lumière LED. Température de couleur - 3000K. Haut degré de protection - IP54.



1 ■ □



2 ■ □

1 ■ **O046SL-L3B3K**
□ **O046SL-L3W3K**

LED 3W 100lm
t° 3000K >80Ra 88°
IP 54

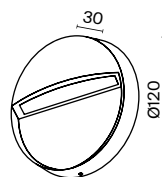

2 ■ **O047SL-L3B3K**
□ **O047SL-L3W3K**

LED 3W 100lm
t° 3000K >80Ra 88°
IP 54

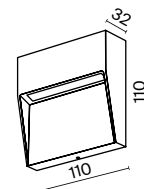

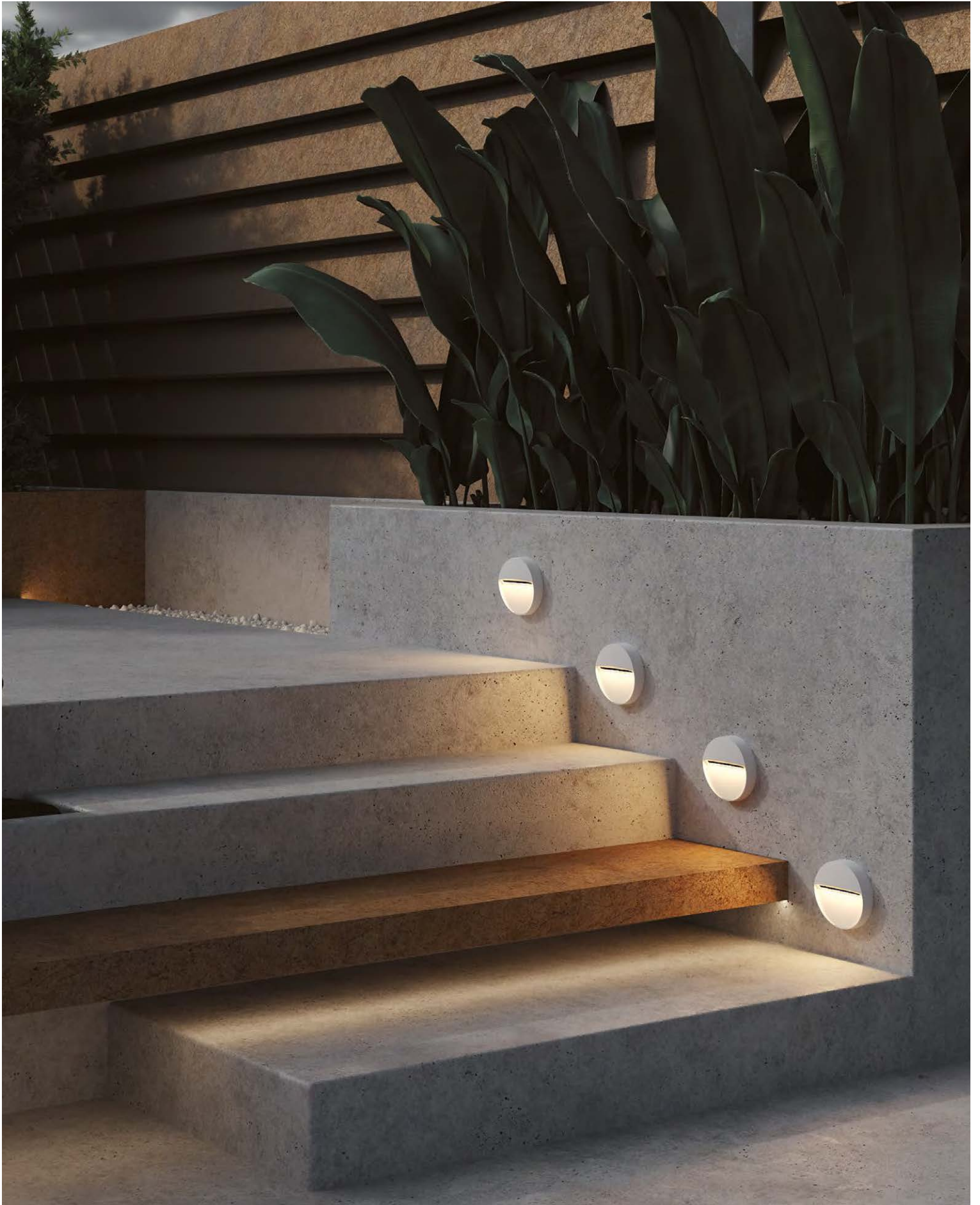

O046SL-L3W3K

Via Urbana

W GR

IP54 LED 

EN Recessed luminaire designed to illuminate paths, stairs and other spaces. Aluminum body, shades – white and grey. Silicone gaskets and protective glass. IP54. Corrosion resistance. It is completed with mounting plastic box.



DE Einbauleuchte zur Beleuchtung von Wegen, Treppen und anderen Räumen. Aluminiumrahmen, Farbtöne: Weiß und Grau. Silikondichtungen und Sicherheitsglas. IP54. Korrosionsbeständig. Eine Kunststoffbox ist im Lieferumfang enthalten.

IT Lampada da incasso per l'illuminazione di sentieri, scale e altri ambienti. Corpo in alluminio, tonalità – bianco e grigio. Guarnizioni in silicone e vetro protettivo. IP54. Resistenza alla corrosione. Scatola di montaggio in plastica inclusa.

FR Luminaire intégrable pour l'éclairage des allées, escaliers et autres espaces. Corps en aluminium, teintes : blanc et gris. Joints en silicone et verre de protection. IP54. Résistance à la corrosion. Boîte d'installation en plastique incluse dans le lot.



1  

1  **O022-L3GR**
 **O022-L3W**

LED 3W 70lm
 t° 4000K >80Ra 30°
 IP 54

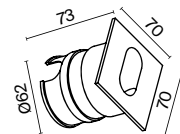

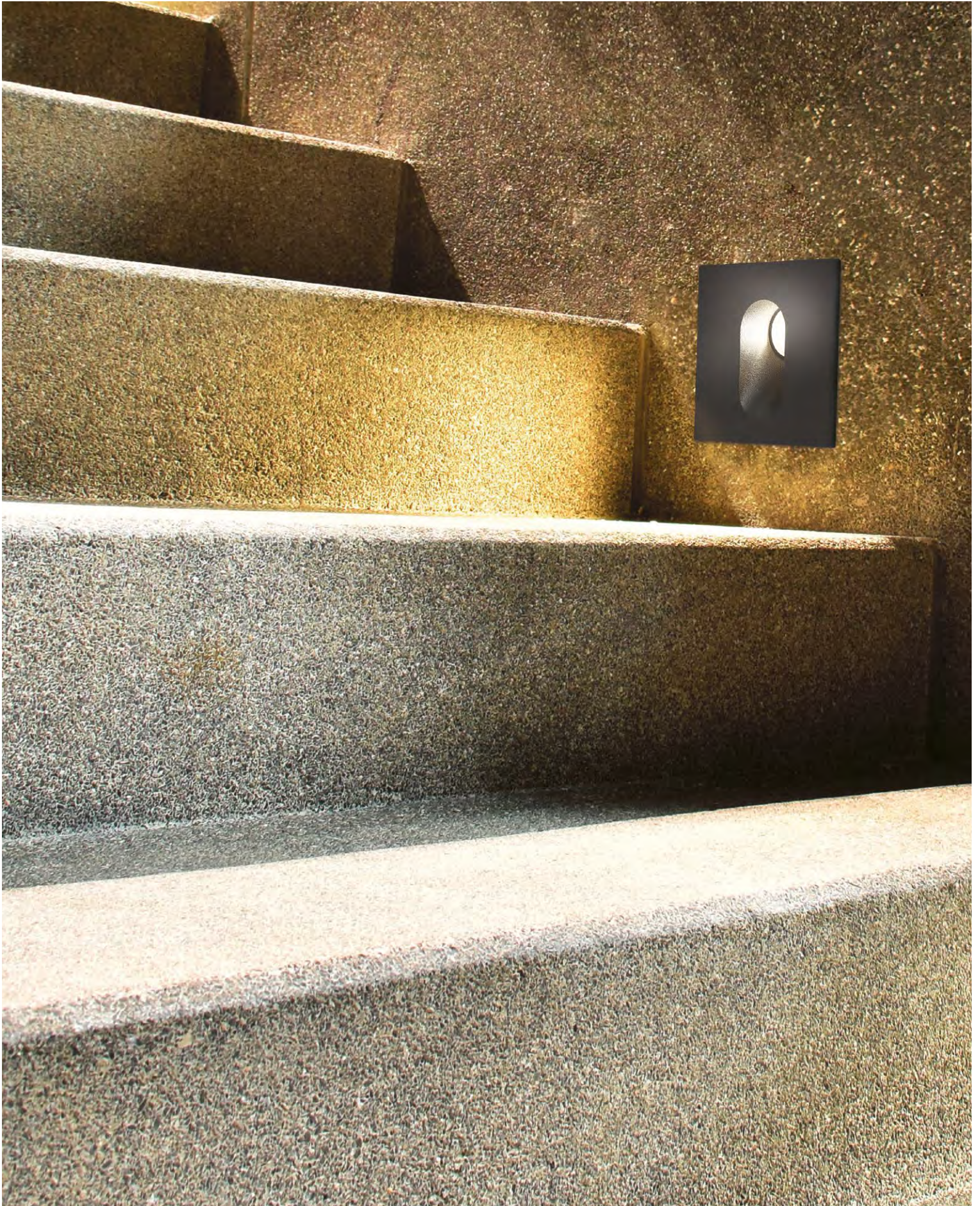

CLASSIC

Maytoni Outdoor

630

LIGHTING

Maytoni Outdoor

Fleur

BZ B
G

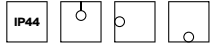

EN Aluminum body, shades – antique bronze and black with gold. Dome lamp – transparent wavy glass. IP44. Protection against corrosion and temperature differences. Light source – lamp with E27 base.

DE Aluminiumrahmen, Farbtöne: Antike Bronze und Schwarz mit Gold. Lampenschirm: Transparentes welliges Glas. IP44. Schutz vor Korrosion und Temperaturschwankungen. Lichtquelle: Leuchtmittel mit einer Fassung E27.

IT Corpo in alluminio nelle tonalità bronzo antico e nero e ottone. Plafoniera: vetro ondulato trasparente. IP44. Protezione dalla corrosione e dagli sbalzi di temperatura. La sorgente luminosa è una lampadina con attacco E27.

FR Corps en aluminium, teintes : bronze ancien et noir avec dorée. Globe : verre ondulé transparent. IP44. Protection contre la corrosion et les changements de températures. Source de lumière : ampoule à culot E27.



1 ■ ■



2 ■ ■



3 ■ ■

1 ■ **O414FL-01BZ1**
■ **O414FL-01GB1**

💡 1 x E27 60 W
IP 44

2 ■ **O414WL-01BZ**
■ **O414WL-01GB**

💡 1 x E27 60 W
IP 44

3 ■ **O414FL-01BZ**
■ **O414FL-01GB**

💡 1 x E27 60 W
IP 44

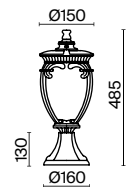
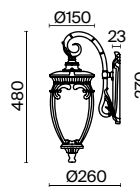
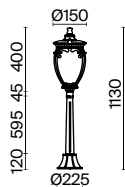

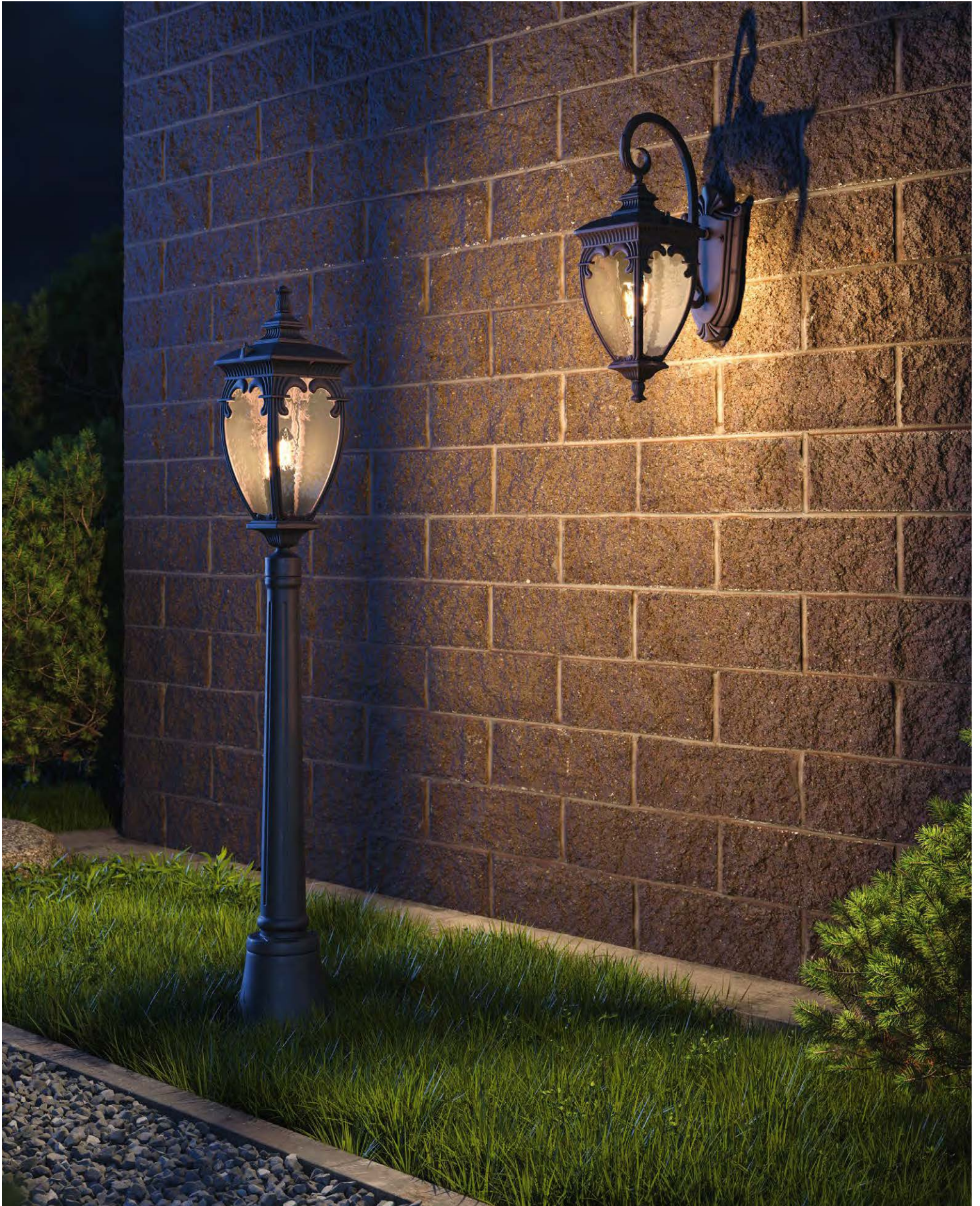

O414FL-01BZ1

O414WL-01BZ

Fleur



4



5

4 **O414FL-03BZ**
O414FL-03GB

💡 3 × E27 60 W
 IP 44

5 **O414PL-01BZ**
O414PL-01GB

💡 1 × E27 60 W
 IP 44

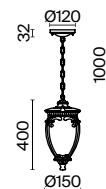
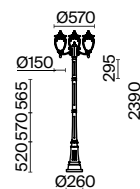



Salamanca

BR



EN Aluminum body is designed using ornamental casting technology. Resistant to corrosion and temperature differences. Powder coating with brown color. Light source – lamp with E27 base.

DE Aluminiumrahmen ist in der Kunstgusstechnologie hergestellt. Beständig gegen Korrosion und Temperaturschwankungen. Pulverbeschichtet in Braun. Lichtquelle: Leuchtmittel mit E27-Fassung.

IT Il corpo in alluminio è realizzato utilizzando la tecnologia di fusione artistica. Resistente alla corrosione e agli sbalzi di temperatura. Verniciato a polvere marrone. Sorgente luminosa – lampadina con attacco E27.

FR Corps en aluminium réalisé par technique de la ferronnerie d'art. Résistant à la corrosion et aux changements de températures. Revêtement par poudre de couleur marron. Source de lumière : ampoule à culot E27.



1 ■



2 ■



3 ■

1 ■ **O031FL-01BR**

💡 1 x E27 60 W
IP 44

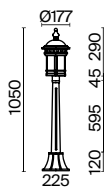

2 ■ **O031PL-01BR**

💡 1 x E27 60 W
IP 44

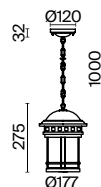

3 ■ **O031WL-01BR**

💡 1 x E27 60 W
IP 44

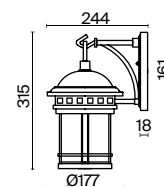



Alphabetical index

DECORATIVE

A	429	ARM172-01-G	430	ARM247-08-G	
	429	ARM172-02-G	431	ARM247-10-G	
	429	ARM172-05-G	432	ARM247-11-G	
	432	ARM247-00-G	431	ARM247-PL-01-G	
	430	ARM247-01-G	422	ARM337-02-R	
	431	ARM247-02-G	422	ARM337-05-R	
	430	ARM247-06-G			
C	418	C232-CL-03-R	420	C908-CL-03-W	
	420	C908-CL-03-R			
D	416	DIA004-01-G	224	DIA200PL-06G	
	416	DIA004-06-G	224	DIA200PL-08G	
	416	DIA004-08-G	224	DIA200WL-02G	
	220	DIA005CL-06CH	406	DIA522-CL-07-G	
	220	DIA005CL-06G	406	DIA522-CL-12-G	
	220	DIA005CL-10CH	417	DIA600-07-G	
	220	DIA005PL-06G	412	DIA700-CL-03-G	
	220	DIA005WL-02G	412	DIA700-CL-06-G	
	380	DIA008PL-05CH	412	DIA700-CL-12-G	
	380	DIA008TL-01CH	412	DIA700-WL-02-G	
	380	DIA008WL-01CH	404	DIA750-TT40-WG	
	402	DIA100-CL-03-G	404	DIA750-TT50-WG	
	402	DIA100-CL-03-N	415	DIA890-CL-05-G	
	402	DIA100-CL-12-G	414	DIA890-CL-06-G	
	402	DIA100-CL-16-G	414	DIA890-CL-18-G	
	402	DIA100-WL-02-G	414	DIA890-WL-01-G	
	402	DIA100-WL-02-N	415	DIA891-CL-14-G	
	410	DIA120-06-G	405	DIA902-04-N	
	410	DIA120-09-G	405	DIA902-06-N	
	H	440	H001CL-05BS	428	H034-WL-02-R
		440	H001CL-07BS	434	H223PL-03G
440		H001TL-01BS	434	H223-PL-03-G	
440		H001WL-01BS	434	H223-PL-05-G	
438		H004CL-05BG	434	H223-WL-01-G	
426		H007PL-04G	436	H260-02-N	
426		H007PL-05G	436	H260-03-N	
426		H007WL-01G	436	H260-05-N	
248		H009PL-06G	421	H356-CL-03-BZ	
248		H009PL-08G			
M		286	MOD005PL-L48BK	182	MOD013FL-01B
		286	MOD005PL-L48BSK	182	MOD013FL-01BS
		288	MOD005WL-L22BSK	182	MOD013PL-02B
	288	MOD005WL-L22BSK1	182	MOD013PL-02BS1	
	288	MOD005WL-L46BSK1	182	MOD013PL-02W	
	74	MOD007PL-08G	184	MOD013PL-04B	
	74	MOD007PL-08G1	184	MOD013PL-04BS1	
	74	MOD007PL-10G	184	MOD013PL-04W	
	74	MOD007WL-01G	184	MOD013PL-06B	
	200	MOD012CL-12G	184	MOD013PL-06BS1	
	200	MOD012WL-02G	184	MOD013PL-06W	

424	MOD014CL-06N	361	MOD058CL-L35B4K
424	MOD014FL-01N	361	MOD058CL-L35BS3K
424	MOD014TL-01N	361	MOD058CL-L35BS4K
424	MOD014WL-01N	364	MOD058PL-L100B3K
358	MOD015CL-L80B	364	MOD058PL-L100B4K
331	MOD015CL-L80GK	364	MOD058PL-L100BS3K
331	MOD015CL-L80W	364	MOD058PL-L100BS4K
331	MOD015CL-L80WK	365	MOD058PL-L22B3K
358	MOD016CL-L80BK	365	MOD058PL-L22BS3K
92	MOD016PL-01BS	363	MOD058PL-L32B3K
92	MOD016PL-06BS	363	MOD058PL-L32B4K
359	MOD016PL-L75B	363	MOD058PL-L32BS3K
358	MOD016PL-L75MG3K	363	MOD058PL-L32BS4K
358	MOD016PL-L75MG4K	362	MOD058PL-L42B3K
359	MOD016PL-L75W	362	MOD058PL-L42B4K
92	MOD016WL-01BS	362	MOD058PL-L42BS3K
279	MOD029-PL-01-W	362	MOD058PL-L42BS4K
250	MOD041PL-L15B3K1	362	MOD058PL-L54B3K
250	MOD041PL-L15GB3K	362	MOD058PL-L54BS3K
251	MOD041PL-L15TR3K	365	MOD058PL-L55B3K
250	MOD041PL-L15W3K1	365	MOD058PL-L55BS3K
251	MOD041PL-L15WG3K	362	MOD058PL-L65B3K
236	MOD043FL-08CH	362	MOD058PL-L65BS3K
236	MOD043FL-08G	364	MOD058PL-L74B3K
238	MOD043PL-04G	364	MOD058PL-L74B4K
238	MOD043PL-06CH	364	MOD058PL-L74BS3K
238	MOD043PL-06G	364	MOD058PL-L74BS4K
238	MOD043PL-12CH	360	MOD058WL-L25B3K
238	MOD043PL-12G	360	MOD058WL-L25BS3K
238	MOD043PL-18CH	360	MOD058WL-L35B3K
238	MOD043PL-18G	360	MOD058WL-L35BS3K
236	MOD043TL-02CH	360	MOD058WL-L50B3K
236	MOD043TL-02G	360	MOD058WL-L50BS3K
236	MOD043WL-01CH	152	MOD061PL-01BS1
236	MOD043WL-01G	152	MOD061WL-01BS
171	MOD048CL-06G	308	MOD070FL-L12B3K
170	MOD048FL-03G	309	MOD070PL-L18B3K
172	MOD048PL-02G	310	MOD070PL-L38B3K
170	MOD048PL-03G	310	MOD070PL-L48B3K
172	MOD048PL-06G	309	MOD070PL-L63B3K
172	MOD048PL-09G	309	MOD070TL-L8B3K
170	MOD048WL-01G	308	MOD070WL-L6B3K
171	MOD048WL-02G	308	MOD070WL-L8B3K
171	MOD050WL-02G	314	MOD072PL-L28B3K1
359	MOD054PL-L52B3K	314	MOD072PL-L28BS3K1
359	MOD054PL-L52B4K	314	MOD072PL-L36B3K1
93	MOD056PL-L12G3K	314	MOD072PL-L36BSK1
366	MOD058A-02B	243	MOD080CL-06CH
366	MOD058A-02BS	243	MOD080CL-08CH
366	MOD058A-03B	196	MOD081CL-L36G3K
366	MOD058A-03BS	196	MOD081CL-L48G3K
361	MOD058CL-L25B3K	102	MOD083PL-04CH
361	MOD058CL-L25B4K	102	MOD083PL-09CH
361	MOD058CL-L25BS3K	102	MOD083WL-02CH
361	MOD058CL-L25BS4K	240	MOD085PL-07BS
361	MOD058CL-L35B3K	240	MOD085PL-07G

240	MOD085PL-12BS	376	MOD151TL-01G
240	MOD085PL-16BS	376	MOD151WL-01G
240	MOD085WL-01BS	378	MOD154PL-L6W3K
240	MOD085WL-01G	378	MOD154PL-L6W3K1
132	MOD089PL-06BS	294	MOD156PL-L52B4K
132	MOD089PL-08BS	294	MOD156PL-L52G4K
132	MOD089PL-10BS	354	MOD157PL-L6B4K1
132	MOD089WL-01BS	354	MOD157PL-L6G4K1
222	MOD094CL-04CH	354	MOD157PL-L6W4K1
222	MOD094CL-04G	350	MOD159PL-L6B4K2
222	MOD094CL-06CH	350	MOD159PL-L6G4K2
222	MOD094CL-06G	350	MOD159PL-L6W4K2
222	MOD094WL-01CH	352	MOD160PL-L6B4K1
222	MOD094WL-01G	352	MOD160PL-L6G4K1
222	MOD094WL-03CH	352	MOD160PL-L6W4K1
222	MOD094WL-03G	356	MOD161PL-01B1
256	MOD095PL-02BS	356	MOD161PL-01BS1
256	MOD095PL-10BS	356	MOD161PL-01CM1
256	MOD095WL-02BS	356	MOD161PL-01G1
232	MOD097WL-02CH	356	MOD161PL-01W1
392	MOD099FL-02G	324	MOD163PL-L38B4K1
390	MOD099PL-03G	324	MOD163PL-L38W4K1
390	MOD099PL-06G	198	MOD164PL-06BS
392	MOD099TL-01G	198	MOD164WL-02BS
390	MOD099WL-01G	198	MOD164WL-02BS1
390	MOD099WL-01G2	318	MOD165PL-L18G3K
392	MOD099WL-01G3	318	MOD165PL-L40G3K
367	MOD102PL-L42B	342	MOD166FL-L15B3K
367	MOD102PL-L42W	342	MOD166PL-L20G3K
300	MOD106CL-L40G3K	340	MOD166PL-L30G3K
300	MOD106PL-L28G3K	340	MOD166PL-L30GB3K
300	MOD106WL-L10G3K	342	MOD166WL-L12G3K
300	MOD106WL-L16B3K	244	MOD167PL-01B
300	MOD106WL-L16G3K	244	MOD167PL-01BG
300	MOD106WL-L16W3K	244	MOD167PL-01GR
276	MOD108PL-14GB	244	MOD167PL-01W
276	MOD108PL-14WG	244	MOD168PL-01B
276	MOD108WL-02GB	244	MOD168PL-01BG
276	MOD108WL-02WG	244	MOD168PL-01GR
180	MOD109PL-08BS	244	MOD168PL-01W
180	MOD109PL-10BS	164	MOD172PL-01B
180	MOD109WL-01BS	164	MOD172PL-01BS
90	MOD112-04-G	164	MOD172PL-06B
90	MOD112-04-N	164	MOD172PL-06BS
90	MOD112-08-G	164	MOD172WL-01B
90	MOD112-08-N	164	MOD172WL-01BS
90	MOD112CL-08G	226	MOD174CL-06G
90	MOD112CL-08N	226	MOD174CL-09G
336	MOD116WL-L7B3K	226	MOD174PL-06G
336	MOD116WL-L7BS3K	226	MOD174WL-02G
218	MOD124PL-L3CH3K	112	MOD175WL-01B
218	MOD124WL-L6CH3K	112	MOD175WL-01G
266	MOD126FL-01B	69	MOD177FL-01B
266	MOD126PL-01B	68	MOD177PL-01B
266	MOD126PL-08B	68	MOD177PL-01G
266	MOD126TL-01B	68	MOD177PL-01W
267	MOD126WL-01B	68	MOD177PL-04B
267	MOD126WL-01B1	68	MOD177TL-01B
304	MOD132PL-L18BK	68	MOD177TL-01W
302	MOD132PL-L18BSK	68	MOD177WL-01B
304	MOD132PL-L30BK	66	MOD178FL-L11B3K
302	MOD132PL-L30BSK	66	MOD178FL-L11G3K
304	MOD132PL-L6BK	66	MOD178FL-L11W3K
302	MOD132PL-L6BSK	66	MOD178PL-01B
94	MOD133CL-04BS	66	MOD178PL-01GR
94	MOD133PL-06BS	66	MOD178PL-01W
340	MOD146PL-L40B3K	66	MOD178PL-L11B3K
340	MOD146PL-L40G3K	66	MOD178PL-L11G3K
312	MOD147FL-L20BK1	66	MOD178PL-L11W3K
312	MOD147FL-L20BSK1	66	MOD178TL-L11B3K
252	MOD150PL-L5BS3K	66	MOD178TL-L11GR3K
252	MOD150PL-L5W3K	66	MOD178TL-L11W3K
376	MOD151PL-05G	334	MOD179PL-L26BS4K

334	MOD179PL-L26W4K	124	MOD221PL-03BS
334	MOD179WL-L22BS4K	124	MOD221PL-03N
334	MOD179WL-L22BS4K1	125	MOD221-PL-05-G
334	MOD179WL-L22W4K	124	MOD221-PL-05-N
334	MOD179WL-L22W4K1	125	MOD221-PL-08-G
322	MOD180WL-L4B3K	125	MOD221-PL-08-N
322	MOD180WL-L4B3K1	125	MOD221PL-10G
322	MOD180WL-L4W3K	125	MOD221PL-10N
322	MOD180WL-L4W3K1	125	MOD221-PL-12-G
179	MOD182PL-L4B3K	125	MOD221-PL-12-N
179	MOD182PL-L4W3K	126	MOD221-TL-01-G
179	MOD182PL-L6B3K	124	MOD221-WL-01-G
179	MOD182PL-L6W3K	124	MOD221-WL-01-N
228	MOD184-PL-01-CH	126	MOD221-WL-02-G
228	MOD184-PL-04-CH	126	MOD221-WL-02-N
228	MOD184-WL-01-CH	72	MOD223PL-03BS
65	MOD185PL-L11B3K1	72	MOD223PL-06BS
65	MOD185PL-L11B3K2	72	MOD223WL-02BS
64	MOD185PL-L11B3K3	72	MOD223WL-02BS1
64	MOD185PL-L6B3K1	192	MOD227PL-01B
64	MOD185PL-L6B3K2	192	MOD227PL-01B1
64	MOD185PL-L6B3K3	192	MOD227PL-01BS
65	MOD185PL-L6B3K4	134	MOD229TL-L3B3K1
65	MOD185PL-L6B3K5	134	MOD229TL-L3B3K2
65	MOD185PL-L6B3K6	134	MOD229TL-L3B3K3
161	MOD187PL-06BS	134	MOD229TL-L3G3K1
161	MOD187PL-08BS	134	MOD229TL-L3G3K2
161	MOD187WL-01BS	134	MOD229TL-L3W3K1
254	MOD189PL-L12B3K1	134	MOD229TL-L3W3K2
254	MOD189PL-L12GR3K1	284	MOD236PL-L54B3K
254	MOD189PL-L12W3K1	284	MOD236PL-L54BS3K
254	MOD189PL-L18B3K1	284	MOD237WL-L11B3K
254	MOD189PL-L18GR3K1	284	MOD237WL-L11BS3K
254	MOD189PL-L18W3K1	284	MOD237WL-L6B3K
264	MOD190CL-L18G3K	284	MOD237WL-L6BS3K
264	MOD190CL-L36G3K	130	MOD238-PL-01-BL
264	MOD190PL-L5G3K	130	MOD238-PL-01-TR
395	MOD191PL-01W	296	MOD242PL-L33BK
395	MOD191PL-01W1	296	MOD242PL-L33BSK
395	MOD192PL-01W	296	MOD243PL-L18BK
395	MOD192PL-01W1	296	MOD243PL-L18BSK
395	MOD193PL-01W	289	MOD244PL-L50BK
396	MOD193PL-01W1	289	MOD244PL-L50BSK
396	MOD194PL-01W	291	MOD245WL-L24BK
396	MOD194PL-01W1	291	MOD245WL-L24BSK
397	MOD195PL-01W	290	MOD246PL-L12BK
396	MOD195PL-01W1	290	MOD246PL-L12BSK
394	MOD197PL-01W	292	MOD246PL-L16BK
394	MOD197PL-01W1	292	MOD246PL-L16BSK
394	MOD197PL-01W2	292	MOD246PL-L24BK
216	MOD201PL-07N	290	MOD246PL-L24BK1
216	MOD201PL-08N	292	MOD246PL-L24BSK
388	MOD204PL-01B	290	MOD246PL-L24BSK1
388	MOD204PL-01B1	289	MOD247PL-L49BK
388	MOD204PL-01BG	289	MOD247PL-L49BSK
388	MOD204PL-01BG1	291	MOD248WL-L24BK
191	MOD207PL-03BS	392	MOD250PL-L36BS3K
190	MOD207PL-05BS	188	MOD254PL-01BS
190	MOD207WL-01BS	188	MOD254PL-05BS
190	MOD207WL-02BS	188	MOD254PL-07BS
191	MOD207WL-04BS	188	MOD254PL-12BS
138	MOD210PL-L39B3K	328	MOD256WL-L5B3K
138	MOD210PL-L39BS3K	328	MOD256WL-L5BS3K1
262	MOD216FL-L38G3K	328	MOD256WL-L5BS3K2
262	MOD216PL-L10G3K	328	MOD256WL-L5BS3K3
262	MOD216PL-L25G3K	185	MOD267FL-L32CH3K
262	MOD216PL-L42G3K	185	MOD267FL-L32G3K
263	MOD216PL-L55G3K	185	MOD267TL-L28CH3K
262	MOD216WL-L10G3K	185	MOD267TL-L28G3K
126	MOD221-FL-01-G	185	MOD267WL-L18CH3K
126	MOD221-FL-01-N	185	MOD267WL-L18G3K
126	MOD221-PL-01-G	178	MOD268CL-01B
126	MOD221-PL-01-N	178	MOD268CL-01G

178	MOD268CL-03B	78	MOD321PL-01G1
178	MOD268CL-03G	81	MOD321PL-01G2
146	MOD270CL-01B	78	MOD321PL-01G3
146	MOD270CL-01G	79	MOD321PL-03B
120	MOD271PL-01B4	80	MOD321PL-03G
120	MOD271PL-01B5	79	MOD321PL-03G1
120	MOD271PL-01B6	79	MOD321PL-05B
120	MOD271PL-01B7	81	MOD321PL-05G
120	MOD271PL-01B8	79	MOD321PL-05G1
120	MOD271PL-01B9	80	MOD321TL-01G3
174	MOD272PL-L12B3K	80	MOD321WL-01B
174	MOD272PL-L12B3K1	80	MOD321WL-01B1
174	MOD272PL-L12BS3K	80	MOD321WL-01G1
174	MOD272PL-L12BS3K1	80	MOD321WL-01G2
174	MOD272PL-L12CH3K	80	MOD321WL-01G3
174	MOD272PL-L12CH3K1	176	MOD322PL-L6B3K
118	MOD273CL-L60CH3K	176	MOD322PL-L6G3K
118	MOD273CL-L60G3K	86	MOD324WL-01B
118	MOD273PL-L16CH3K	86	MOD324WL-01BS
118	MOD273PL-L16G3K	86	MOD324WL-01CH
118	MOD273PL-L33CH3K	98	MOD325PL-01G
118	MOD273PL-L33G3K	98	MOD325PL-06G
118	MOD273PL-L80CH3K	98	MOD325PL-06G1
118	MOD273PL-L80G3K	98	MOD325WL-02G
316	MOD276PL-L40B3K	122	MOD326PL-01B
316	MOD276PL-L40W3K	122	MOD326PL-01MG
393	MOD277FL-L24GR3K	122	MOD326PL-01W
344	MOD278CL-L50G3K	248	MOD326WL-02B
344	MOD278PL-L50G3K	248	MOD326WL-02MG
344	MOD278PL-L86G3K	248	MOD326WL-02W
344	MOD278PL-L86G3K1	160	MOD327PL-L5BS3K
346	MOD279WL-L14B3K	160	MOD327WL-L5BS3K
346	MOD279WL-L14G3K	160	MOD327WL-L5BS3K1
282	MOD280PL-L23B3K	274	MOD410PL-L12BS3K
282	MOD280PL-L30B3K	274	MOD410PL-L12CH3K
96	MOD281CL-L45BS3K	274	MOD410WL-L12BS3K
96	MOD281FL-L33BS3K	274	MOD410WL-L12CH3K
97	MOD281PL-L34BS3K	204	MOD411PL-03G
97	MOD281PL-L45BS3K	204	MOD411PL-06G
96	MOD281TL-L15BS3K	204	MOD411WL-01G
140	MOD282PL-L8G3K	332	MOD415PL-L36BS4K
140	MOD282PL-L8G3K1	332	MOD415PL-L45BS4K
140	MOD282TL-L15G3K	332	MOD415PL-L60BS4K
140	MOD282TL-L15G3K1	268	MOD417WL-01B
343	MOD283CL-L34BS3K	268	MOD417WL-01BS
343	MOD283TL-L12BS3K	268	MOD417WL-01W
116	MOD285WL-L10B3K	84	MOD419WL-01B
116	MOD285WL-L10BS3K	84	MOD419WL-01G
70	MOD302PL-01CG	270	MOD421WL-L6B3K
70	MOD302PL-01GR	270	MOD421WL-L6BBS3K
70	MOD302PL-01W	270	MOD421WL-L6BS3K
70	MOD302WL-01CG	270	MOD421WL-L6W3K
70	MOD302WL-01GR	78	MOD521PL-01G1
70	MOD302WL-01W	78	MOD521PL-01G3
70	MOD302WL-02CG	76	MOD521PL-03G
70	MOD302WL-02GR	76	MOD521PL-05G
70	MOD302WL-02W	76	MOD521WL-01G1
257	MOD303PL-01CFL2	76	MOD521WL-01G3
257	MOD303PL-01CFL3	104	MOD545CL-12B
166	MOD304TL-01CH	106	MOD545CL-12BS
166	MOD304TL-01G	107	MOD545CL-20B
202	MOD308PL-L9CG3K	107	MOD545CL-20BS
202	MOD308PL-L9CH3K	108	MOD545PL-06B
202	MOD308WL-L9CG3K	108	MOD545PL-06BS
202	MOD308WL-L9CH3K	108	MOD545PL-06CH
242	MOD313PL-04G	108	MOD545PL-06G
242	MOD313PL-06G	108	MOD545PL-11B
298	MOD315CL-L25CH3K	108	MOD545PL-11BS
298	MOD315CL-L25G3K	108	MOD545PL-11CH
88	MOD317PL-04G	108	MOD545PL-11G
88	MOD317PL-06G	106	MOD545PL-12CH
79	MOD321PL-01B	106	MOD545PL-12G
79	MOD321PL-01B1	106	MOD545PL-20CH

106	MOD545PL-20G	104	MOD547WL-09G
104	MOD545PL-24B	108	MOD547WL-13B
108	MOD545PL-24BS	108	MOD547WL-13BS
104	MOD545PL-24CH	108	MOD547WL-13CH
104	MOD545PL-24G	108	MOD547WL-13G
107	MOD545PL-25B	107	MOD548PL-25CH
107	MOD545PL-25BS	107	MOD548PL-25G
108	MOD545WL-03B	159	MOD555CL-L28G3K
108	MOD545WL-03BS	159	MOD555FL-L23G3K
108	MOD545WL-03CH	156	MOD555PL-L11G3K
108	MOD545WL-03G	158	MOD555PL-L18G3K
104	MOD547PL-25B	158	MOD555PL-L35G3K
104	MOD547PL-25BS	158	MOD555TL-L8G3K
104	MOD547PL-25CH	156	MOD555WL-L11G3K
104	MOD547PL-25G	158	MOD555WL-L13G3K
104	MOD547WL-05B	159	MOD555WL-L3G3K
104	MOD547WL-05BS	159	MOD555WL-L4G3K
104	MOD547WL-05CH	370	MOD613CL-03W
104	MOD547WL-05G	370	MOD613CL-03W1
104	MOD547WL-09B	370	MOD613CL-04GR
104	MOD547WL-09BS	370	MOD617CL-04GR
104	MOD547WL-09CH		

P	148	P001PL-01BZ	338	P096PL-L11WK
	148	P003PL-01BZ	338	P096PL-L11WK1
	144	P011PL-01CH	234	P097PL-L28BS3K
	144	P011PL-01G	234	P097PL-L36BS3K
	168	P060TL-L12BK	232	P097PL-L36G4K
	168	P060TL-L12BSK1	232	P097PL-L45G4K
	100	P069PL-L16G3K	234	P097PL-L48BS3K
	100	P069PL-L17CH3K	232	P097PL-L90G4K
	100	P069PL-L17G3K	128	P140-PL-110-1-G
	100	P069PL-L35CH3K	128	P140-PL-110-1-N
	100	P069PL-L35CH3K1	128	P140-PL-170-1-G
	100	P069PL-L35G3K1	128	P140-PL-170-1-N
	320	P080PL-01B	128	P140-PL-170-5-G
	320	P080PL-01W	128	P140-PL-170-5-N
	194	P090PL-L12CH3K	384	P359-PL-01-W
	194	P090WL-L24CH3K	384	P359-PL-140-C
	162	P091PL-L18G3K	384	P359-PL-140-W
	162	P091WL-L18G3K	384	P359-PL-220-C
	131	P095PL-01BZ	196	P361PL-01G
	131	P095PL-01BZ1	196	P362PL-01G
	338	P096PL-L11BK	196	P363PL-01G
	338	P096PL-L11BK1	272	P364PL-01G

R	432	RC247-FL-01-R	432	RC247-TL-01-R
	409	RC247-PL-06-R	409	RC247-WL-01-R
	408	RC247-PL-08-R	408	RC247-WL-02-R
	408	RC247-PL-10-R		

S	368	SPR-BASE-03-B	368	SPR-BASE-R-02-W
	368	SPR-BASE-03-W	368	SPR-BASE-R-03-B
	368	SPR-BASE-R-02-B	368	SPR-BASE-R-03-W

T	150	T163-01-C	142	T532CL-08B
	150	T163-01-R	142	T532CL-12B
	150	T163PL-01R	142	T532WL-02B
	386	T434-PL-01-GR	153	T546PL-12B
	386	T451-PL-01-GR	153	T546PL-18B

Z	374	Z002FL-01B	114	Z020FL-L12BS3K
	205	Z005TL-01BS	114	Z020PL-L6B3K
	306	Z010FL-L8B3K	114	Z020PL-L6BS3K
	306	Z010TL-L8B3K	382	Z030TL-01BS
	306	Z010TL-L8W3K	382	Z031TL-01BS
	326	Z012FL-L18B3K	419	Z153-TL-01-BS
	326	Z012TL-L8B3K	372	Z177FL-01B
	278	Z014TL-01G	372	Z177-FL-01-BR
	114	Z020FL-L12BK	372	Z177FL-01W

OUTDOOR

O











590	0010FL-01B	474	O412WL-L8GF3K
590	0010FL-02B	632	O414FL-01BZ
590	0010WL-02B	632	O414FL-01BZ1
624	0014SL-L3B3K	632	O414FL-01GB
624	0014SL-L3W3K	632	O414FL-01GB1
616	0015SL-L3B3K	634	O414FL-03BZ
616	0015SL-L3W3K	634	O414FL-03GB
582	0019FL-L12GR3K	634	O414PL-01BZ
582	0019FL-L13GR3K	634	O414PL-01GB
586	0020WL-L10B4K	632	O414WL-01BZ
584	0021FL-L10B3K	632	O414WL-01GB
584	0021WL-L10B4K	514	O415FL-L15B3K
628	0022-L3GR	514	O415FL-L15GR3K
628	0022-L3W	478	O417WL-L4B3K
598	0025FL-01B	478	O417WL-L4GR3K
598	0025FL-01B1	478	O417WL-L4W3K
598	0025WL-01B	478	O417WL-L6B3K
636	0031FL-01BR	478	O417WL-L6GR3K
636	0031PL-01BR	478	O417WL-L6W3K
636	0031WL-01BR	578	O418CL-01B
596	0033WL-L3W3K	578	O418CL-01GR
596	0033WL-L7B3K	578	O418FL-01B
618	0035-L3B3K	578	O418FL-01B1
618	0035-L3W3K	578	O418FL-01GR
618	0036-L3B3K	578	O418FL-01GR1
622	0037-L3B3K	578	O418WL-01B
622	0037-L3W3K	578	O418WL-01GR
620	0045SL-L3B3K	552	O419WL-01B
620	0045SL-L3W3K	552	O419WL-01GR
620	0045SL-L5B3K	552	O419WL-01W
620	0045SL-L5W3K	552	O419WL-02B
626	0046SL-L3B3K	552	O419WL-02GR
626	0046SL-L3W3K	552	O419WL-02W
626	0047SL-L3B3K	578	O420FL-L12GF
626	0047SL-L3W3K	578	O420FL-L12GF1
498	0050FL-L15GF3K	480	O420WL-L12GF
498	0050FL-L15W3K	480	O420WL-L7GF
498	0050FL-L30GF3K	530	O422FL-L12GF
498	0050FL-L30W3K	530	O422FL-L6GF
498	0050FL-L5GF3K	528	O423FL-L5GF
498	0050FL-L5W3K	516	O424FL-L10GF
610	0303WL-L10GF3K	516	O424FL-L20GF
610	0303WL-L10W3K	516	O424FL-L25GF
610	0303WL-L24GF3K	500	O425FL-L10GF
610	0303WL-L24W3K	500	O425FL-L20GF
610	0303WL-L5GF3K	500	O425FL-L25GF
610	0303WL-L5W3K	540	O427FL-L12GF3K
494	0306CL-L12GF	540	O427FL-L30GF3K
494	0306CL-L7GF	538	O428WL-L10GF3K
556	0307CL-01B	538	O428WL-L10W3K
602	0309CL-L10GF3K	538	O428WL-L20GF3K
602	0309CL-L8GF3K	538	O428WL-L20W3K
608	0310CL-L12GF3K	572	O429WL-L10GF3K
608	0310CL-L12W3K	572	O429WL-L6GF3K
608	0310CL-L5GF3K	580	O430CL-L15B3K
608	0310CL-L5W3K	580	O430CL-L15W3K
474	O412WL-L5GF3K	580	O431CL-L30B3K

580	O431CL-L30W3K	593	O574WL-01W
506	O432FL-01GF	593	O574WL-02B
506	O432FL-01GF1	593	O574WL-02GR
506	O432WL-01GF	593	O574WL-02W
506	O432WL-02GF	594	O576FL-01B
476	O433WL-L4GF3K	594	O576FL-01B1
476	O433WL-L4W3K	594	O576FL-01GR
472	O435WL-L10GF3K	594	O576FL-01GR1
472	O435WL-L5GF3K	594	O576WL-01B
502	O436WL-L10GF3K	594	O576WL-01GR
502	O436WL-L10GF3K1	594	O576WL-02B
502	O436WL-L20GF3K	594	O576WL-02GR
522	O437FL-01GF	484	O577WL-L5B
522	O437FL-01GF1	588	O578FL-01B
490	O438CL-L12GF3K	588	O578WL-02B
566	O439FL-L12GF3K	482	O580WL-L6B
566	O439WL-L12GF3K	482	O580WL-L6W
606	O440FL-L12GF3K	482	O581WL-L6B
606	O440FL-L18GF3K	592	O582WL-02B
606	O440FL-L24GF3K	592	O582WL-02BS
612	O441FL-L1GF3K	592	O583WL-01B
612	O441FL-L1GF3K1	592	O583WL-01W
558	O442WL-L12GF3K	592	O583WL-02B
558	O442WL-L12GF3K1	592	O583WL-02W
562	O443FL-L12GF3K	532	O590FL-L8B4K
562	O443WL-L12GF3K	532	O590FL-L8B4K1
568	O446FL-L7GF3K	532	O590WL-L8B4K
568	O446WL-L7GF3KSR	542	O591FL-L12GF3K
568	O446WL-W7GF3K	542	O591FL-L12GF3K1
524	O447WL-L7GF3K	526	O592FL-L15GF3K
560	O448WL-L9GF3KSR	536	O593FL-L12BR3K
504	O449WL-01GF	536	O593FL-L12GF3K
504	O449WL-01GF1	536	O593FL-L20BR3K
512	O450WL-01GF	536	O593FL-L20GF3K
512	O451WL-01GF	518	O594FL-01W
510	O452FL-01GF	518	O594FL-01W1
510	O452FL-01GF1	518	O594PL-01B
509	O452FL-01GF2	518	O594PL-01W
509	O452FL-01GF3	544	O595FL-L12B3K
508	O452WL-01GF	544	O595WL-L12B3K
508	O452WL-01GF1	520	O596FL-L9B4K
508	O452WL-01GFSR	520	O596FL-L9B4K1
496	O453FL-01GF	520	O596FL-L9GR4K
496	O453WL-01GF	520	O596FL-L9GR4K1
496	O453WL-02GF	600	O598FL-01B
492	O454WL-L10GF3K	600	O598FL-01GR
492	O454WL-L10GF3K1	600	O598WL-01B
570	O455FL-01GF	600	O598WL-01B1
570	O455FL-01GF1	600	O598WL-01GR
574	O458FL-L9GF3K	600	O598WL-01GR1
574	O458WL-L9GF3K	546	OSL456FL-L2GF3K
486	O572WL-L6B	546	OSL456WL-L2GF3K
486	O572WL-L6W	564	OSL457WL-L2GF3K
486	O573WL-L6B	550	OSL599FL-L5B3K
486	O573WL-L6W	550	OSL599FL-L5B3K1
593	O574WL-01B		
593	O574WL-01GR		

Explication

 Number of lamps







IP Degree of protection against moisture

 New	Type of lamp
 Degree of protection against moisture	 Chandeliers, pendants
 LED lamps	 Ceiling lamps
	 Wall lamps
	 Floor lamps
CRI level	 Table lamp
 >90	 Portable lamp

Lighting control protocols

	Type of fastening
 Dimmable	 Bulb socket
	 Clip

Type of light diffusion

 Straight	
 Reflected	 Light sensor
 Scattered	 Motion sensor
 Mixed	 Solar battery

Color temperature

2700K	Warm light like incandescent lamp or sunrise/sunset
3000K	Warm white light
4000K	Neutral white light, reminiscent of the color of daytime Sun

IP PROTECTION RATING

The first digit is the level of protection against the ingress of solid particles.

0 – no protection

1 – protection against the impact of external objects with a diameter of more than 50 mm

2 – protection against the impact of external objects with a diameter of more than 12 mm

3 – protection against the impact of external objects with a diameter of more than 2.5 mm

4 – protection against the impact of external objects with a diameter of 1 mm or more

5 – full protection against contact, dust can get into the device partially (does not affect the functionality)

6 – full protection against contact, dust cannot get into the device

The second digit is moisture protection

0 – no protection

1 – protection against condensate

2 – protection against water drops

3 – protection against raindrops

4 – protection against water splashes





























5 – protection against water jets

6 – protection against water

7 – protection against water penetration when immersed to a depth of 1 meter

8 – protection against water penetration during prolonged immersion

Color index

 B	Black	 AM	Amber
 GR	Grey	 CG	Cognac
 W	White	 CR	Cream
 AW	Antique white	 MR	Marmor
 TR	Transparent	 BG	Beige
 G	Gold	 BR	Brown
 MG	Matte gold	 WD	Wooden
 AG	Antique gold	 T	Terracotta
 PG	Pearl gold	 BL	Blue
 BS	Brass	 CFL	Colorful
 BZ	Bronze		
 ABZ	Antique bronze		
 C	Copper		
 N	Nickel		
 CH	Chromium		
 S	Silver		
 GF	Graphite		
 SM	Smoky		