



rabalux[®]
Outdoor 2025

WELCOME • ÜDVÖZÖLJÜK • WILLKOMMEN

“

DEAR PARTNERS AND CUSTOMERS!



We are delighted to present Rábalux first catalogue exclusively featuring outdoor lighting solutions. This publication combines cutting-edge technologies, trend-following designs, and energy efficient solutions.

Beyond our homes, outdoor spaces also deserve to be stylish, functional, and inspiring. Light not only provides security and comfort in the outdoors, but also defines and enhances the beauty of our surroundings.

Explore our extensive selection including our timeless, classic-style lamps and our modern products with smart solutions. Get inspired, design and create with us the outdoor spaces of your dreams!

We wish you a pleasant browse through our new catalogue!

”

“

KEDVES PARTNEREINK ÉS VÁSÁRLÓINK!



Örömmel mutatjuk be a Rábalux első, kizárólag kültéri világítási megoldásait tartalmazó katalógusát. Ebben a kiadványban a legújabb technológiák, az aktuális trendeket követő design és az energiatakarékos megoldások találkoznak.

Az otthonunkon túl a kültéri terek is megérdemlik, hogy stílusosak, funkcionálisak és inspirálóak legyenek. A fény nem csupán biztonságot és kényelmet nyújt a szabadban, de meghatározza a hangulatot, és kiemeli környezetünk szépségét.

Fedezze fel széles kínálatunkat, amelyben éppúgy helyet kaptak klasszikus, időtálló lámpáink, mint modern, energiatakarékos megoldásokat kínáló termékeink is. Inspirálódjon, tervezzen, és alkossa meg velünk álmai kültereit!

Kellemes böngészést kívánunk új katalógusunkhoz!

”

“

SEHR GEEHRTE PARTNER UND KUNDEN!



Mit großer Freude präsentieren wir Ihnen den ersten Rábalux Katalog, der ausschließlich Außenbeleuchtungslösungen umfasst. In dieser Ausgabe treffen modernste Technologien auf trendbewusstes Design und energieeffiziente Lösungen.

Auch Außenbereiche verdienen es stilvoll, funktional und inspirierend zu sein. Licht bietet im Freien nicht nur Sicherheit und Komfort, sondern schafft auch Atmosphäre und unterstreicht die Schönheit unserer Umgebung.

Entdecken Sie unser umfangreiches Sortiment, das sowohl unsere zeitlosen, klassischen Lampen als auch moderne Produkte mit intelligenten Lösungen umfasst. Lassen Sie sich inspirieren, planen Sie und gestalten Sie mit uns Ihre Traum-Garten!

Wir wünschen Ihnen viel Freude beim Durchblättern unseres neuen Katalogs!

”



CONTACT • ELÉRHETŐSÉGEK • KONTAKT

CENTRE/KÖZPONT/ZENTRALE



Magyarország/Hungary

RÁBALUX HEAD OFFICE
RÁBALUX VILÁGÍTÁSTECHNIKA ZRT.
VILÁGÍTÁSTECHNIKA GYÁRTÁS ÉS FORGALMAZÁS/
LIGHTING PRODUCTION AND DISTRIBUTION

H-9027 Győr, Körtefa u. 5.
Tel.: +36 96 526 716
E-mail: info@rabalux.com
www.rabalux.com

AFFILIATES/LEÁNYVÁLLALATOK/ZWEIGSTELLEN



Bulgaria

РАБАЛУКС ЕООД / RABALUX EOOD
ул. "Андрей Николов" №15,
1111 София,
България
Тел/Факс: +359 2 936 00 97
E-mail: infobg@rabalux.com
www.rabalux.bg



Croatia, Bosnia Herzegovina, Montenegro



RABALUX RASVIJETA d.o.o.
Ulica grada Gospića 1a
10000 Zagreb
Tel.: +385 1 652 80 66
E-mail: infocro@rabalux.com
www.rabalux.hr



Czech Republic

RABALUX CZ Svítidla s.r.o.
Kaštanová 141/a, 617 00 Brno,
Česká Republika
Tel.: +420 739 665 322
E-mail: infocz@rabalux.com
www.rabalux.cz



Hungary

Rábalux Magyarország Kft.
Magyarország
H-9027 Győr,
Körtefa u. 5.
Tel.: +36 96 526 716
E-mail: infohu@rabalux.com
www.rabalux.hu



Poland

Rabalux Sp. z o.o.
ul. Sołtysia 119, 40-750 Katowice,
Polska
Tel.: +48 32 254 61 34
E-mail: infopl@rabalux.com
zamowienia@rabalux.com
www.rabalux.pl



Romania

SC RABALUX SRL
Cluj-Napoca, str. Fabricii,
nr. 93-103, jud. CLUJ
Romania
cod postal: 400632
Tel.: +40 264 456 040
E-mail: infofo@rabalux.com
www.rabalux.ro



Serbia, Northern Macedonia



Rabalux SRB d.o.o.
Autoput br.20
11080 Beograd –
Zemun, Srbija
Mob: + 381 60 444 3977;
Tel.: +381(0)11 2013 986
E-mail: infosrb@rabalux.com
www.rabalux.rs



Slovakia

RABALUX SK. Svetidlá, s.r.o.
Alžbetínske nám. 328,
929 01 Dunajská Streda,
Slovenská Republika
Tel.: +421 31 551 54 04
E-mail: infofok@rabalux.com
www.rabalux.sk



Ukraine

ТОВ Рабалукс,
вул. Рилєєва 4, м. Ужгород,
Україна, 88017
тел.: +38 0312 64 04 00,
моб.тел.: +38 067 310 05 20
E-mail: infoou@rabalux.com
www.rabalux.ua

OFFICIAL RESELLERS/MEGBÍZOTT VISZONTELADÓK/BEAUFTRAGTE WIEDERVERKÄUFER



Germany

Sinnocon GmbH
01156 Dresden,
Breitscheidstr. 45
Tel.: +49 351 65335641
E-mail: rabalux@sinnocon.de
www.sinnocon.de



Slovenia

Lagea d.o.o.
Brezina 19c
8250 Brežice
Republika Slovenija
Tel.: +386 70 292 70 20
E-mail: elmatis@lagea.si



Greece

ANASTASIADI SA
1km Katerini-Ganohora Road,
Katerini, 60100
Tel.: +30 2351039757
E-mail: eshop@anastasiadi.gr
www.anastasiadi.gr



Greece

S.MELISSOURGOS CO OE
8 Kourtiou St,
11146 Galatsi,
Tel.: +0030 2102136040
E-mail: info@melissourgos.com.gr
www.melissourgos.com.gr



Portugal

STORM LIGHT,LDA
Rua António Pereira Vidal Xavier nº,
3750-802 Valongo do Vouga,
Tel.: 234 661 068
E-mail: geral@storm-light.pt
www.storm-light.pt



Spain

Buyled Led Lighting S.L
03007, Alicante,
ES, C/Gillen de Castro 1
Tel.: +0034 633460731
E-mail: info@buyled.es
www.buyled.es



Italy

Fra.Co.Distribuzione Srl
Sp1 km24,
90047 Partinico (PA)
Tel.: 0039 0915071547
E-mail: info@fracodistribuzione.it
www.fracodistribuzione.it



Finland

Focus Interiors Oy
Kuusipolku 35,
37150 Nokia
Tel.: +358 (0)10 3270 520
E-mail: info@focusinteriors.fi
www.focusinteriors.fi



Albania

FAAM Light sh.p.k.
Rruga Muhedin Llagani,
Kompleksi Square 21,
Tirana, Albania
Tel.: +355 67 446 6888
E-mail: info@faamlight.al
www.faamlight.al



United Kingdom

Lighting Direct
24-26 Vincent Ave,
Crownhill, Milton Keynes
Buckinghamshire, MK8 0AB
E-mail: customerservice@lighting-direct.co.uk
www.lighting-direct.co.uk



Estonia

Lambipesa OÜ
Tel.: +372 5124235
E-mail: eve@lambipesa.ee
www.lambipesa.ee



Lithuania, Latvia

UAB LEDOK
Birutes str. 2,
Klaipėda 91200, Lithuania
Tel.: +37062068111
E-mail: B2B@ledok.lt
www.ledok.lt

CONTACT • ELÉRHETŐSÉGEK • KONTAKT



DESIGNED BY RABALUX



Discover our „Designed by Rabalux” collection, look for the label in our catalogue!

Fedezze fel saját tervezésű lámpakollekcióinkat, keresse a jelzést katalógusunkban!

Entdecken Sie unsere „Designed by Rabalux” Collection, suchen Sie nach dem Logo in unserem Katalog!



designed by
rabalux®

EN Our passion for light and design – now extended to outdoor spaces!

Our team’s primary goal is to create something new, unique, and exciting from both technological and aesthetic perspectives. This year, we are opening a new chapter: presenting our very first collection of outdoor lighting, designed with the same dedication as our indoor and lighting products.

Our mission goes beyond selling lamps; we aim to inspire and set trends. Our uniquely designed lamps are meant to make outdoor spaces truly special with practical, energy-efficient, and trendsetting solutions.

HU Szendvélyünk a fény és a design – most a kültéri terek számára is!

Csapatunk legfőbb törekvése, hogy mind technológiai, mind esztétikai szempontból újat, egyedit és izgalmasat alkossunk. Idén egy új fejezetet nyitunk: bemutatjuk első saját tervezésű kültéri lámpakollekcióinkat, amely ugyanazzal az elkötelezettséggel készült, mint beltéri és fényforrás termékeink.

Küldetésünk nem csupán az, hogy lámpákat értékesítsünk, hanem hogy inspiráljunk és stílust teremtünk. Az egyedire tervezésű lámpáink célja, hogy a kültéri terek is igazán különlegessé legyenek – praktikus, energiatakarékos és trendkövető megoldásokkal.

DE Unsere Leidenschaft für Licht und Design – jetzt auch für Außenbereiche!

Das Hauptziel unseres Teams ist es, sowohl aus technologischer als auch aus ästhetischer Sicht neues, einzigartiges, und aufregendes zu schaffen. Dieses Jahr eröffnen wir ein neues Kapitel: wir präsentieren unsere allererste Kollektion an Außenleuchten, die mit derselben Hingabe entworfen wurde wie unsere Innenbeleuchtungs- und Lichtquellen Produkte.

Unsere Mission geht über den Verkauf von Lampen hinaus; wir möchten inspirieren und Trends setzen. Unsere einzigartig gestalteten Lampen sollen Außenbereiche wirklich besonders machen – mit praktischen, energieeffizienten und trendbewussten Lösungen.



DESIGNED BY RABALUX

EN We are delighted to present our first collection of self-designed outdoor lighting - the CUBBINGTON range - which we hope will inspire our customers and partners as much as our existing products.

Our new outdoor collection has been created with a focus on combining technological innovation with design. Each luminaire is designed to go beyond light to become an integral part of outdoor spaces, adding style and unique character.

HU Örömmel mutatjuk be első saját tervezésű kültéri lámpakollekciónkat – a CUBBINGTON lámpacsaládot - amely reményeink szerint ugyanúgy inspirálni fogja vásárlóinkat és partnereinket, mint eddigi termékeink.

Új kültéri kollekciónk megalkotása során a technológiai újítások és a formatervezés ötvözésére helyeztük a hangsúlyt. Minden egyes lámpa célja, hogy a fényen túl a kültéri terek szerves részévé váljon, stílust és egyedi karaktert adva azoknak.

DE Wir freuen uns, unsere erste selbst entworfene Kollektion von Außenleuchten vorzustellen - die CUBBINGTON-Reihe - von der wir hoffen, dass sie unsere Kunden und Partner genauso inspirieren wird wie unsere bestehenden Produkte.

Bei der Entwicklung unserer neuen Kollektion für den Außenbereich lag der Schwerpunkt auf der Kombination von technologischer Innovation und Design. Jede Lampe ist so konzipiert, dass sie nicht nur Licht spendet, sondern ein integraler Bestandteil des Außenbereichs wird und ihm Stil und einzigartigen Charakter verleiht.



DESIGNED BY RABALUX

EN Lighting is not just a function but a defining element of a space's atmosphere and character. This principle guided the design process of the Cubbington product line, where modern design, functionality, and creativity converge.

This uniquely designed outdoor lighting collection is based on the pure aesthetics of geometric shapes, combining a cube and a rectangular prism to create a simple yet powerful visual impact. The constructivist style highlights clean lines and structural stability while its elegant appearance makes it a perfect fit for the exterior spaces of modern, minimalist homes.

HU A világítás nem csupán funkció, hanem a tér hangulatának és karakterének meghatározó eleme. A Cubbington termékcsalád megalkotásakor ez az elv vezérelte a tervezési folyamatot, amely során a modern design, a funkcionalitás és a kreativitás találkozott.

Ez az egyedi tervezésű kültéri lámpacsalád a geometrikus formák tiszta esztétikájára épül, ötvözve egy kockát és egy hasábot, így egyszerű, mégis erőteljes vizuális hatást kelt. A konstruktivista stílus kiemeli a letisztult vonalakat és a szerkezet stabilitását, miközben elegáns megjelenésével tökéletesen illeszkedik a modern, minimalista otthonok külső tereibe.

DE Beleuchtung ist nicht nur eine Funktion, sondern ein prägendes Element für die Atmosphäre und den Charakter eines Raumes. Dieses Prinzip leitete den Designprozess der Cubbington-Produktlinie, bei der modernes Design, Funktionalität und Kreativität aufeinandertreffen.

Diese einzigartig gestaltete Außenleuchten-Kollektion basiert auf der klaren Ästhetik geometrischer Formen, bei der ein Würfel und ein Quader kombiniert werden, um eine einfache, aber kraftvolle visuelle Wirkung zu erzielen. Der konstruktivistische Stil betont klare Linien und strukturelle Stabilität, während das elegante Erscheinungsbild perfekt zu den Außenbereichen moderner, minimalistischer Häuser passt.



DESIGNED BY RABALUX

EN The rotating head of the Cubbington lamp allows users to fully customize the direction of the light, offering both direct and indirect lighting options. This flexibility makes the lamp an ideal choice for illuminating various outdoor spaces such as gardens, pathways, or patios. The black color suggests elegance, while the high lumen value ensures that every detail is well lit in the surrounding environment.

The product family consists of three pieces: two wall lamps and one unique, specially designed floor lamp. The wall lamps can be mounted both horizontally and vertically, offering additional options to create a customized look.

The design of the Cubbington lamps is protected by a Rábalux patent, making these products exclusively available in our collection. This distinctive range provides not only a practical lighting solution but also becomes a defining, dynamic, and decorative element in your outdoor spaces, elevating the style and atmosphere to a new level.

HU A Cubbington lámpafejének forgathatósága lehetővé teszi, hogy a felhasználók teljes mértékben személyre szabják a fény irányát, ezzel biztosítva mind a direkt, mind az indirekt világítás lehetőségét. Ez a rugalmasság ideális választássá teszi a lámpát különböző kültéri helyszínek – kertek, ösvények vagy teraszok – megvilágítására. A fekete szín eleganciát sugall, míg a magas lumenérték gondoskodik arról, hogy minden részlet jól látható legyen a környezetben.

A termékcsalád három tagból áll: két fali lámpából és egy különleges, egyedi megjelenésű állólámpából. A fali lámpák horizontálisan és vertikálisan is felszerelhetők, így további lehetőségeket kínálnak az egyedi megjelenés kialakításához.

A Cubbington lámpák formatervezése Rábalux védett formaoltalom alatt áll, így ezeket a termékeket kizárólag nálunk találhatja meg. Ez az egyedi kollekciónemcsak praktikus világítási megoldást nyújt, hanem kültéri terei meghatározó, dinamikus és dekoratív elemévé is válik, új szintre emelve azok stílusát és hangulatát.

DE Der drehbare Lampenkopf der Cubbington-Lampe ermöglicht es den Nutzern, die Lichtrichtung vollständig anzupassen und sowohl direkte als auch indirekte Beleuchtungsoptionen zu bieten. Diese Flexibilität macht die Lampe zur idealen Wahl für die Beleuchtung verschiedener Außenbereiche wie Gärten, Wege oder Terrassen. Die schwarze Farbe vermittelt Eleganz, während der hohe Lumenwert dafür sorgt, dass jedes Detail in der Umgebung gut beleuchtet ist.

Die Produktfamilie besteht aus drei Teilen: zwei Wandleuchten und einer einzigartigen, speziell designten Stehlampe. Die Wandleuchten können sowohl horizontal als auch vertikal montiert werden, was zusätzliche Möglichkeiten bietet, einen individuellen Look zu gestalten.

Das Design der Cubbington-Lampen ist durch ein Rábalux-Patent geschützt, sodass diese Produkte ausschließlich in unserer Kollektion erhältlich sind. Diese einzigartige Reihe bietet nicht nur eine praktische Beleuchtungslösung, sondern wird auch zu einem prägende, dynamischen und dekorativen Element in Ihren Außenbereichen, das Stil und Atmosphäre auf ein neues Niveau hebt.



01

**MODERN
PRODUCT
FAMILIES**

Modern
termékcsaládok

Moderne
Produktfamilien

24-57

02

**WALL AND
CEILING LAMPS**

Fali- és
mennyezetlámpák

Wand- und
Deckenlampen

58-111

03

**CLASSIC
PRODUCT
FAMILIES**

Klasszikus
termékcsaládok

Klassische
Produktfamilien

112-137

04

**TABLE,
DECORATIVE,
AND SOLAR
LAMPS**

Asztali, dekor,
napelemes lámpák

Tisch-, Dekor- und
Solarlampen

138-169





CUBBINGTON
77183
26



CUBBINGTON
77184
26



CUBBINGTON
77185
26



KALISZ
77031
27



KALISZ
77032
27



KALISZ
77033
27



TELDE
77101
28



TELDE
77102
28



MEDNA
77103
28



MEDNA
77104
28



CERNON
77054
29



CERNON
77055
29



CERNON
77056
29



ODIEL
77057
30



ODIEL
77058
30



ODIEL
77059
30



ODIEL
77060
30



WENGEN
77148
31



WENGEN
77149
31



PALANGA
7504
32



PALANGA
7505
32



PALANGA
7506
32



TOLNA
77171
33



TOLNA
77172
33



TOLNA
77173
33



DARVAS
77126
34



DARVAS
77127
34



DARVAS
77128
34



LEITHA
77130
35



LEITHA
77131
35



LEITHA
77132
35



ENOL
77110
36



ENOL
77111
36



ENOL
77112
36



ENOL
77113
36



BELFAST
7904
37



ELVA
7929
37



ELVA
7930
37



ANKARA
77122
38



ANKARA
7379
38



ANKARA
7380
38



ANKARA
77025
38



ANKARA
77026
38



WELLINGTON
7502
39



WELLINGTON
7503
39



KOLTA
7386
39



KOLTA
7387
39



LOANDA
77080
40



LOANDA
77081
40



LOANDA
77082
40



TEPLICE
7158
41



TEPLICE
7159
41



TEPLICE
77027
41



WALES
7195
42



WALES
7196
42



WALES
7197
42



ZERNEST
77085
43



ZERNEST
77086
43



ZERNEST
77087
43



TARPA
77106
44



TARPA
77107
44



TARPA
77108
44



HAREN
77083
45



HAREN
77084
45



SAVANO
7266
45



SAVANO
7267
45



PARAVENTO
7146
46



PARAVENTO
7147
46



PARAVENTO
7148
46



PARAVENTO
7149
46



PARAVENTO
7150
46



TAVERNA
7127
48



TAVERNA
7128
48



TAVERNA
7129
48



TAVERNA
7130
48



DUBROVNIK
7238
49



DUBROVNIK
7239
49



DUBROVNIK
7240
49



ALMADA
7884
50



ALMADA
7885
50



BUDAPEST
8888
51



BUDAPEST
8889
51



BUDAPEST
8890
51



BLACK TORCH
8145
52



BLACK TORCH
8146
52



BLACK TORCH
8147
52



BLACK TORCH
8148
52



BONN
8337
53



BONN
8338
53



BONN
8339
53



INOX TORCH
8261
54



INOX TORCH
8263
54



INOX TORCH
8264
54



INOX TORCH
8265
55



INOX TORCH
8266
55



INOX TORCH
8267
55



INOX TORCH
8268
55



LISBON
7826
56



LISBON
7827
56



LISBON
7828
56



LISBON
7829
56



TILBURG
77049
60



TILBURG
77050
60



OGNON
77051
60



NAVIA
8130
61



FOLLINA
8154
61



TEMSE
77065
61



TEMSE
77066
61



RUST
77151
62



RUST
77152
62



RUST
77153
62



HALLSTATT
77168
63



HALLSTATT
77169
63



HALLSTATT
77170
63



SOLIN
7396
64



SOLIN
7397
64



KELEBIA
77125
64



LIPPA
7317
65



LIPPA
7318
65



LIPPA
7319
65



LIPPA
7320
65



NESNA
7951
66



NESNA
7952
66

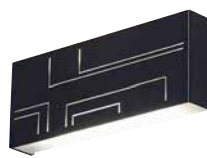

MARIBOR
8873
66



MARIBOR
8874
66



IBAR
77109
67



BIRMINGHAM
8795
67



MATARO
77114
67



HULST
77041
67



KOBARID
77174
67



GIMONE
77098
68



GIMONE
77097
68



ANDELLE
77095
68



ANDELLE
77096
68



RENNES
77042
68



ZARAGOZA
77092
69



ZARAGOZA
77093
69



ZARAGOZA
77115
69



ZARAGOZA
77116
69



BALIMO
7476
70



BALIMO
7477
70



BALIMO
7478
70



BALIMO
7479
70



BATIDA
77117
71



BATIDA
77118
71



BATIDA
77119
71



BATIDA
77120
71



VARNA
8134
72



VARNA
8135
72



BONA
8060
72



HALDEN
7935
72



SENICA
77064
73



LAXA
77121
73



RAPLA2
77150
73



MATARO
77073
74



MATARO
77074
74



MATARO
77075
74



MATARO
77076
74



MANDAL
7959
75



MANDAL
7960
75



BUFFALO
7887
75



BUFFALO
7888
75



URFA
77154
76



URFA
77155
76



URFA
77156
76



URFA
77157
76



URFA
77161
77



URFA
77162
77



URFA
77163
77



URFA
77164
77



MEDINA
8832
78



MEDINA
8833
78



MEDINA
8834
78



MEDINA
8835
78



CHILE
8020
79



CHILE
8029
79



CHILE
8030
79



CHILE
8034
79



CHILE
8018
79



CHILE
8019
79



SINTRA
7955
80



SINTRA
7956
80



PHOENIX
8118
80



PHOENIX
8119
80



NOVIGRAD
7236
81



NOVIGRAD
7237
81



SILISTRA
7891
81



SILISTRA
7892
81



ORLOVA
7244
81



MENDOZA
7109
82



MENDOZA
7110
82



LUBLIN
77099
82



LUBLIN
77100
82



OPOLE
7796
83



OPOLE
7797
83



MANHATTAN
8359
83



MANHATTAN
8510
83



GENDT
77061
83



ROMA
8409
84



ROMA
8410
84



ROMA
8511
84



ROMA
8776
84



SEATTLE
8169
85



SEATTLE
8229
85



RODEZ
8940
85



SEVILLA
8799
85



SEVILLA
8800
85



ZOMBOR
7817
86



ZOMBOR
7818
86



ZOMBOR
7819
86



ZOMBOR
7820
86



AKRON
8149
86



AKRON
8150
86



KOVEN
71342
87



KOVEN
71343
87



COCO
5274
87



COCO
5275
87



COCO
5276
87



INVERNESS
7774
89



INVERNESS
7775
89



TARTU
7893, 7894
90



TARTU
7895, 7896
90



TARTU
7897, 7898
91



TARTU
7899, 7900
91



LOWAR
77133, 77182, 77135
92



LOWAR
77134, 77181, 77136
92



ZENON
2697, 2698
93



INDRE
77035
93



INDRE
77036
93



ALENZO
71425, 71426
94



ALENZO
71435, 71436
94



ALENZO
71427, 71429
95



ALENZO
71437, 71439
95



ALENZO
71422, 71423
96



ALENZO
71432, 71433
96



ALENZO
71424
97



ALENZO
71434
97



ALENZO
71428, 71430
98



ALENZO
71438, 71440
98



ALENZO
71431
99



ALENZO
71441
99



SAMIRA
71252, 71253, 71254
100



SAMIRA
71255, 71256
100



SAMIRA
71257, 71258, 71259
101



SAMIRA
71260, 71261
101



ERIC
7979
102



LUCAS
3437, 3438, 3439
102



GAELO
75025, 75026
103



PERNIK
7250
103



PERNIK
7265
103



LARCIA
75009
104



LARCIA
75010
104



AUSTIN
8797
104



STUTTART
8170
105



STUTTART
8220
105



STUTTART
8227
105



STUTTART
8683
105



STUTTART
8684
105



STUTTART
8685
105



LARCIA
75011
107



LARCIA
75012
107



LUCAS
71132, 71133, 71134
107



LOWAR
77137, 77138
108



LOWAR
77139, 77140
108



ZENON
2699, 2700
109



HITURA
77028
110



HITURA
77029
110



LENTIL
5810
110



HORT
7406
111



HORT
7407
111



HORT
7408
111



HORT
7409
111



NIZZA
8451
114



NIZZA
8452
114



NIZZA
8458
114



MONACO
8181
115



MONACO
8182
115



MONACO
8184
115



MONACO
8185
115



MONACO
8186
115



TORONTO
8380
116



TORONTO
8381
116



TORONTO
8382
116



TORONTO
8385
116



TORONTO
8460
116



TOSCANA
8391
117



TOSCANA
8392
117



TOSCANA
8394
117



TOSCANA
8395
117



MILANO
8370
118



MILANO
8371
118



MILANO
8372
118



MILANO
8376
118



MILANO
8373
119



MILANO
8374
119



MILANO
8375
119



MILANO
7837
120



MILANO
8341
120



MILANO
8342
120



MILANO
8344
120



MILANO
8345
120



MILANO
8346
120



VELECE
8202
121



VELECE
8204
121



VELECE
8206
121



VELECE
8208
121



VELECE
8210
121



VELECE
8217
121



VELECE
8201
122



VELECE
8203
122



VELECE
8205
122



VELECE
8207
122



VELECE
8209
122



VELECE
8216
122



VELECE
8218
123



VELECE
8232
123



VELECE
8234
123



VELECE
8236
123



VELECE
8238
123



VELECE
8240
123



ODESSA
8163
124



ODESSA
8164
124



ODESSA
8165
124



BARCELONA
8677
125



BARCELONA
8678
125



BARCELONA
8679
125



MADRID
7836
126



MADRID
8377
126



MADRID
8476
126



MADRID
8379
127



MADRID
8480
127



MARSEILLE
8570
128



MARSEILLE
8617
128



MARSEILLE
8618
128



MARSEILLE
8568
129



MARSEILLE
8569
129



KONSTANZ
8245
130



KONSTANZ
8246
130



KONSTANZ
8247
130



KONSTANZ
8248
130



VIGO
8686
131



VIGO
8687
131



OSLO
8270
132



OSLO
8763
132



OSLO
8764
132



OSLO
8271
133



OSLO
8681
133



OSLO
8736
133



OSLO
8737
133



OSLO
8739
133



OSLO
8740
133



OSLO
8680
134



OSLO
8682
134



OSLO
8716
134



OSLO
8717
134



HAGA
8243
135



HAGA
8244
135



SYDNEY
8387
135



SYDNEY
8388
135



DARIUS
8190
136



ZATON
7070
136



DURANGO
8766
136



DURANGO
8767
136



HEKTOR
8496
137



HEKTOR
8499
137



NORVICH
8753
137



NORVICH
8754
137



YAGO
3309
137



YAGO
3310
137



ASSEN
77062
140



ISHTAR
76007
140



ODERA
7040
141



TAENA
76010
141



TAENA
76013
141



KONIN
77089
141



POLPERRO
77146
142



POLPERRO
77147
142



FUNES
77143
143



FUNES
77144
143



FUNES
77145
143



BURDUR
77142
143



SAVOCA
77167
144



TAPOLCA
77176
144



SLUIS
77046
144



MEDULIN
7032
145



YOLA
7850
145



LENTULA
7010
145



KROBIA
7814
147



TURDA
7060
147



NANTES
77088
147



KELNA
77011
147



AMARILLO
7969
148



AMARILLO
7980
148



TACOMA
8714
148



BOVEN
71169
148



BOVEN
71170
148



TRENTO
8893
149



TRENTO
8894
149



TRENTO
77105
149



PUEBLO
8011
149



ALASKA
77017
151



ALASKA
77018
151



GELEEN
77044
152



GELEEN
77045
152



LASSET
77078
152



LASSET
77079
152



ANGERS
77037
153



ANGERS
77038
153



ANGERS
77039
153



MOSELLE
77014
154



QESA
77005
154



KAPUAS
77015
154



BREZNO
77006
155



NARMADA
77004
155



LUTTO
77030
155



SEPIK
77013
156



KANGTON
77024
156

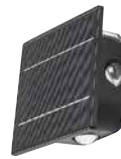

EMMEN
77034
156



OSTRAVA
7880
157



OSTRAVA
7881
157



OPAVA
7970
157



TARCAL
77159
158



TARCAL
77160
158



FLAXTON
77040
158



FLAXTON
77090
158



LIHULL
77020
159



LESZNO
77091
159



MELK
77141
160



ZAVOD
77129
160



DOJRAN
77021
161



VALPOVO
77019
161



ZLARIN
77012
161



WIGRY
77001
162

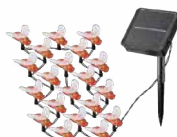

BOBUS
77002
162



XIMPU
77003
162



ZIRC
77165
163

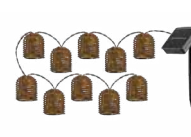

RUPIT
77047
163



TITU
77048
163



SKADAR
77007
164



TREPPIO
77008
164



FUNGHETTO
7877
164



RAVELLO
77158
165



MONOR
77177
165



HOLNE
77188
165



CONG
77186
165



MORA
8948
166



MORA
8949
166



SOLAR 1
8365
166



SOLAR 1
8366
166



BILBAO
8104
167



DANNET
7975
167



BOKOD
77187
167



TRILLO
77175
167



ANSOO
77016
168



BIRI
77123, 77124
168



LED STRIP
79021, 79022
169





01

MODERN PRODUCT FAMILIES

MODERN TERMÉKCSALÁDOK

MODERNE PRODUKTFAMILIEN



CUBBINGTON



77183

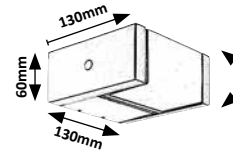

77185

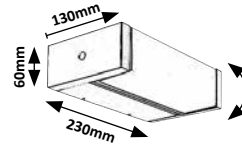

77184

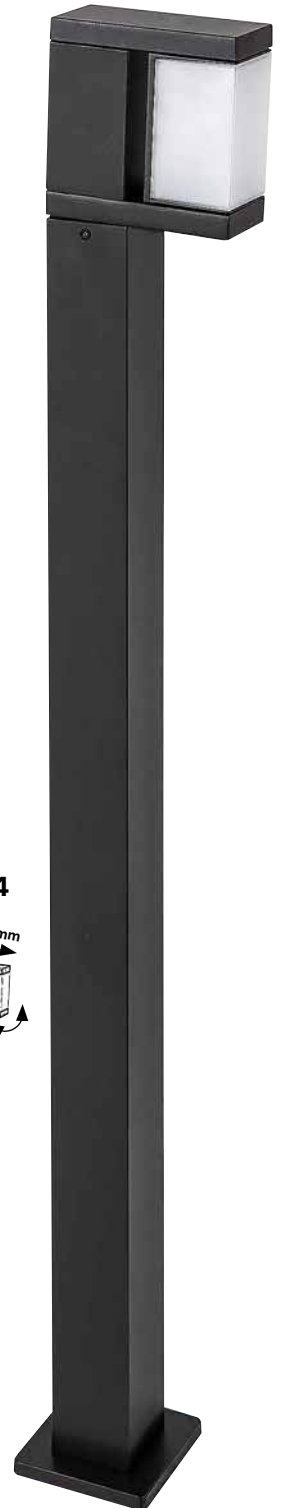
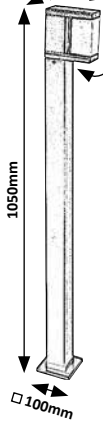

77183 (M P)

LED / 10W
(720lm, 1200lm;
4000K) incl. • IP54
black/white



5 996595 771836

77184 (M P)

LED / 10W
(740lm, 1200lm;
4000K) incl. • IP54
black/white



5 996595 771843

77185 (M P)

LED / 18W
(1460lm, 2200lm;
4000K) incl. • IP54
black/white



5 996595 771850

KALISZ



77031



77033

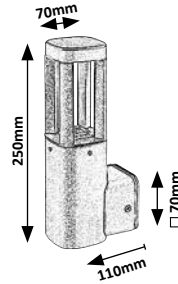

77032

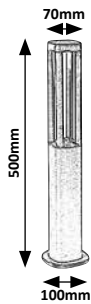

Item nr. 77031 is not available in every country. On demand, please contact our customer service.

A 77031 termék nem elérhető minden országban. Igény esetén vegye fel a kapcsolatot ügyfélszolgálatunkkal.

Das Produkt 77031 ist nicht in jedem Land verfügbar. Bei Bedarf kontaktieren Sie unseren Kundenservice.

Concreting of the base is required.

A talp bebetonozása szükséges.

Das Betonieren des Sockels ist erforderlich.

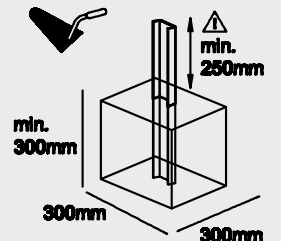

77031 (M) (P)

LED / 30W
(2450lm, 3100lm;
3000K) incl. • IP65
anthracite/white



5 996595 770310

77032 (M) (P)

LED / 7W
(250lm, 700lm;
3000K) incl. • IP54
anthracite/white



5 996595 770327

77033 (M) (P)

LED / 7W
(250lm, 700lm;
3000K) incl. • IP54
anthracite/white



5 996595 770334



TELDE



77101

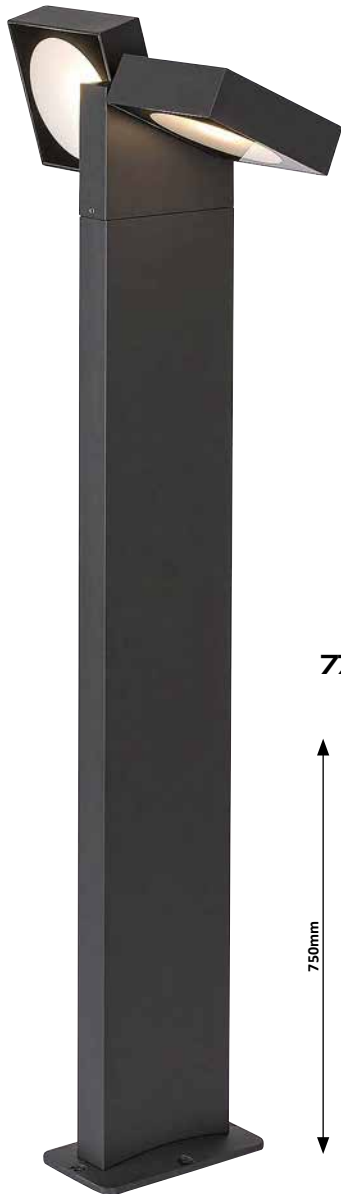
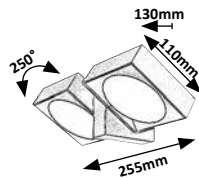

77102

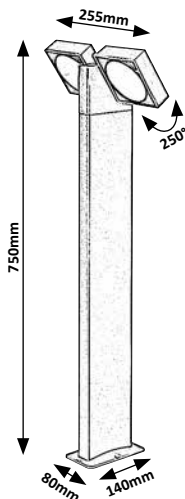

MEDNA



77103

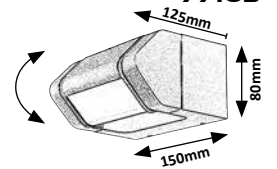

77104

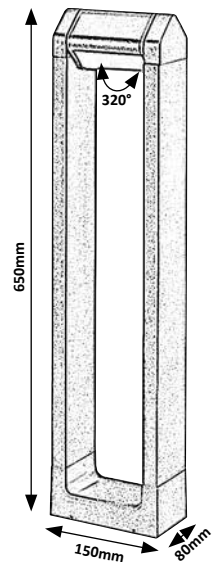

77101 (M) (G)

LED / 14W
 (900lm, 1620lm;
 3000K) incl. • IP54
 anthracite/transparent



5 996595 771010

77102 (M) (G)

LED / 14W
 (900lm, 1620lm;
 3000K) incl. • IP54
 anthracite/transparent



5 996595 771027

77103 (M) (P)

LED / 8W
 (530lm, 930lm;
 3000K) incl. • IP54
 anthracite/white



5 996595 771034

77104 (M) (P)

LED / 8W
 (530lm, 930lm;
 3000K) incl. • IP54
 anthracite/white



5 996595 771041

CERNON



77054

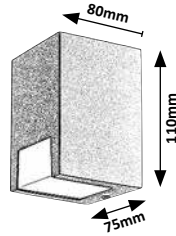

77055

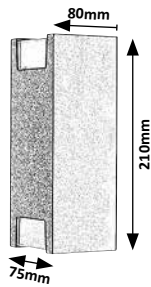

77056

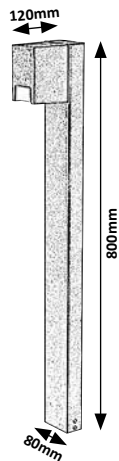

77054 (M) (P)

☒ GU10 / 1x max. 7W
IP44 • 20048
black/white



5 996595 770549

77055 (M) (P)

☒ GU10 / 2x max. 7W
IP44 • 20049
black/white



5 996595 770556

77056 (M) (P)

☒ GU10 / 1x max. 7W
IP44 • 20048
black/white



5 996595 770563



ODIEL



77057

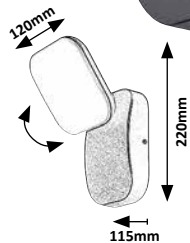

77059

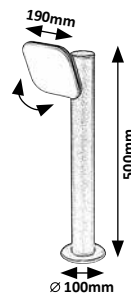

77058

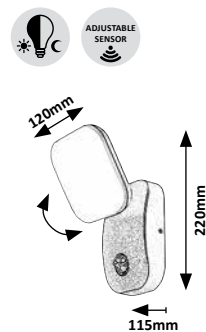

77060

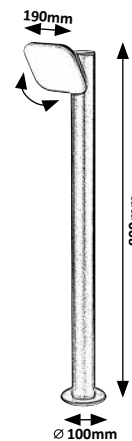

77057 (M) (P)

LED / 12W
 (800lm, 1400lm;
 3000K) incl. • IP44
 black/white



77058 (M) (P)

LED / 12W
 (850lm, 1400lm; 3000K) incl.
 IP44 • 8±2m, 110°
 black/white



77059 (M) (P)

LED / 12W
 (750lm, 1400lm;
 3000K) incl. • IP44
 black/white



77060 (M) (P)

LED / 12W
 (720lm, 1400lm;
 3000K) incl. • IP44
 black/white



WENGEN



77148 (M) (P)

LED / 12W
 (☼790lm, ☼1100lm;
 3000K) incl. • IP54
 black/white



5 996595 771485

77149 (M) (P)

LED / 12W
 (☼790lm, ☼1100lm;
 3000K) incl. • IP54
 black/white



5 996595 771492



PALANGA



7504



7505



7506

7504 (M) (P)

LED / 12W
(800lm, 3000K) incl.
IP44
anthracite/white



7505 (M) (P)

LED / 12W
(800lm, 3000K) incl.
IP44 • 7m, 106°
anthracite/white



7506 (M) (P)

LED / 12W
(800lm, 3000K) incl.
IP44
anthracite/white



TOLNA



77171



77173

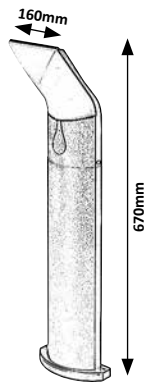

77172

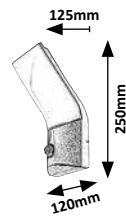

77171 (M) (P)

LED / 10W
 (750lm, 1200lm;
 3000K) incl. • IP54
 black/white



5 996595 771713

77172 (M) (P)

LED / 10W
 (770lm, 1200lm;
 3000K) incl. • IP54
 0-10m, 120° • black/white



5 996595 771720

77173 (M) (P)

LED / 10W
 (740lm, 1200lm;
 3000K) incl. • IP54
 black/white



5 996595 771737

77126, 77127, 77128



DARVAS



77126

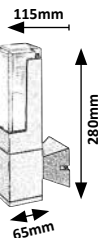

77127

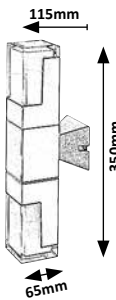

77128

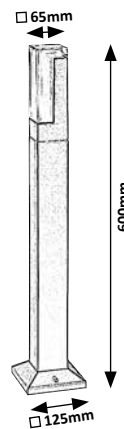

77126 (M P)

LED / 7W
 (450lm, 970lm;
 2700K, 4000K, 6000K) incl. • IP54
 black/white/transparent



5 996595 771263

77127 (M P)

LED / 12W
 (830lm, 1600lm;
 2700K, 4000K, 6000K) incl. • IP54
 black/white/transparent



5 996595 771270

77128 (M P)

LED / 7W
 (450lm, 970lm;
 2700K, 4000K, 6000K) incl. • IP54
 black/white/transparent



5 996595 771287

LEITHA



77130

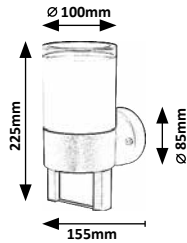

77131

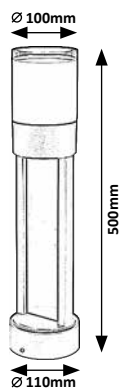

77132

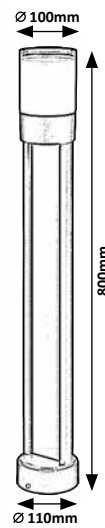

77130 (M) (P)

LED / 12W
 (☒740lm, ☒1300lm;
 3000K) incl. • IP44
 black/white



5 996595 771300

77131 (M) (P)

LED / 12W
 (☒720lm, ☒1300lm;
 3000K) incl. • IP44
 black/white



5 996595 771317

77132 (M) (P)

LED / 12W
 (☒700lm, ☒1300lm;
 3000K) incl. • IP44
 black/white



5 996595 771324



ENOL



MOVEABLE HEADS



79105



New



77110 (M G)

☒ GU10 / 1x max. 35W
IP44
black/transparent



5 996595 771102

77111 (M G)

☒ GU10 / 2x max. 35W
IP44
black/transparent



5 996595 771119

77112 (M G)

☒ GU10 / 1x max. 35W
IP44
black/transparent



5 996595 771126

77113 (M G)

☒ GU10 / 2x max. 35W
IP44
black/transparent



5 996595 771133

ELVA



MOVEABLE HEADS

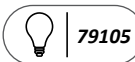

7930

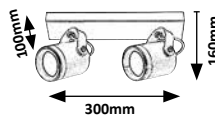

7929

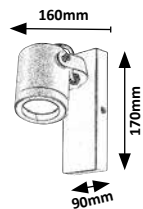

BELFAST



INDIRECT

MOVEABLE HEADS



7904

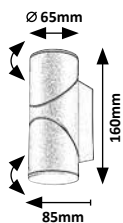

7929 **M G**

☒ GU10 / 1x max. 35W
IP44
anthracite/transparent



5 998250 379296

7930 **M G**

☒ GU10 / 2x max. 35W
IP44
anthracite/transparent



5 998250 379302

7904 **M P**

☒ LED / 12,9W
(620lm, 3000K) incl.
IP65
anthracite/white



5 998250 379043

ANKARA



7380

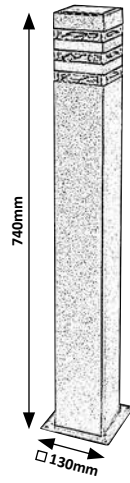

7379

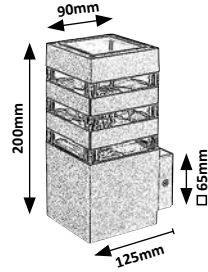

77025

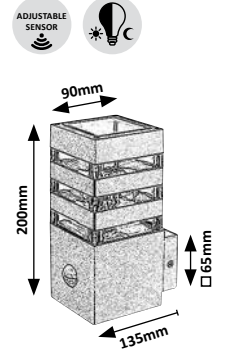

77026

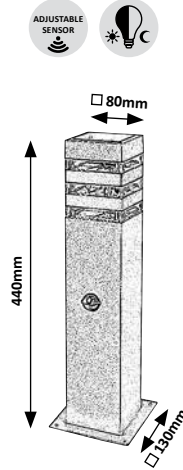

77122

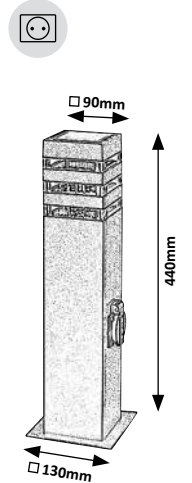

7380 (M) (P)

☒ E27 / 1x max. 12W
IP44
anthracite/transparent



5 998250 373805

7379 (M) (P)

☒ E27 / 1x max. 12W
IP44
anthracite/transparent



5 998250 373799

77026 (M) (G)

☒ E27 / 1x max. 12W
IP44 • 6-8m, 105°
anthracite/transparent



5 996595 770266

77025 (M) (P)

☒ E27 / 1x max. 12W
IP44 • 6-8m, 105°
anthracite/transparent



5 996595 770259

77122 (M) (P)

☒ E27 / 1x max. 12W
IP44
black/transparent



5 996595 771225

WELLINGTON



7502

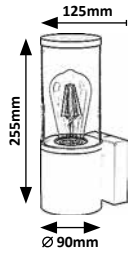

7503

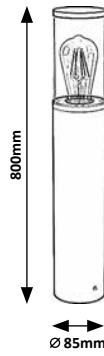

77122



KOLTA



7386

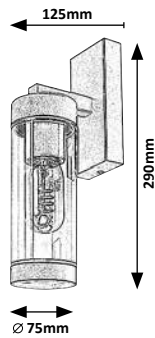

7387

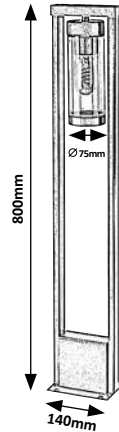

7502 (M) (P)

☒ E27 / 1x max. 60W
IP44 • 19978
matte black/transparent



5 998250 375021

7503 (M) (P)

☒ E27 / 1x max. 60W
IP44 • 19978
matte black/transparent



5 998250 375038

7386 (M) (P)

☒ E27 / 1x max. 12W
IP44 • 19150
matte black/transparent



5 998250 373867

7387 (M) (P)

☒ E27 / 1x max. 12W
IP44 • 19150
matte black/transparent



5 998250 373874

LOANDA



77080

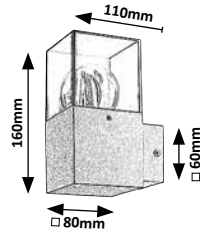

77081

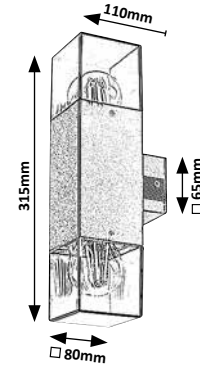

77082

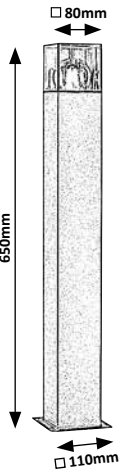

77080 (M) (P)

⊗ E27 / 1x max. 12W
IP44 • 20051
black/tinted colour



5 996595 770808

77081 (M) (P)

⊗ E27 / 2x max. 12W
IP44 • 20051
black/tinted colour



5 996595 770815

77082 (M) (P)

⊗ E27 / 1x max. 12W
IP44 • 20051
black/tinted colour



5 996595 770822

TEPLICE

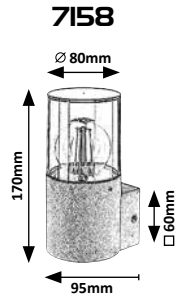

7158

∅ 80mm

170mm

95mm

60mm



7159

∅ 80mm

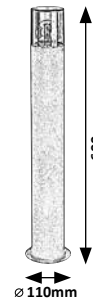

600mm

∅ 110mm



77027



∅ 80mm

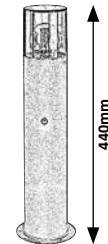

440mm



7158 (M) (P)

⊗ E27 / 1x max. 12W
IP44 • 19156
matte black/tinted colour



5 998250 371580

7159 (M) (P)

⊗ E27 / 1x max. 12W
IP44 • 19156
matte black/tinted colour



5 998250 371597

77027 (M) (P)

⊗ E27 / 1x max. 12W
IP44 • 19156
6-8 m, 105°
matte black/tinted colour



5 996595 770273

WALES



7195

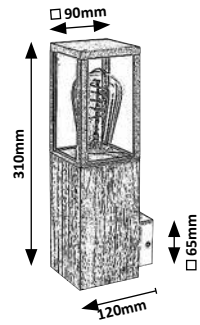

7196

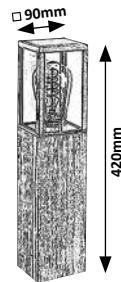

7197

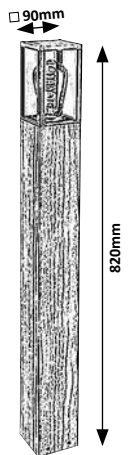

7195 (M G)

⊗ E27 / 1x max. 60W
IP44 • 19271
oak/transparent/black



7196 (M G)

⊗ E27 / 1x max. 60W
IP44 • 19271
oak/transparent/black



7197 (M G)

⊗ E27 / 1x max. 60W
IP44 • 19271
oak/transparent/black



ZERNEST



77085

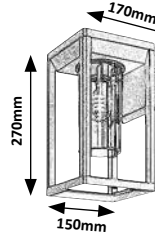

77086

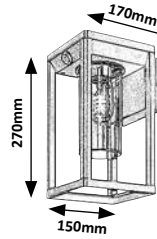

77087

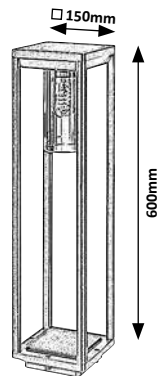

77085 (M) (P)

☒ E27 / 1x max. 15W
IP54 • 20056
black/transparent



5 996595 770853

77086 (M) (P)

☒ E27 / 1x max. 15W
IP54 • 20056
☺ 2-6m, 110°
black/transparent



5 996595 770860

77087 (M) (P)

☒ E27 / 1x max. 15W
IP54 • 20056
black/transparent



5 996595 770877

TARPA



77106

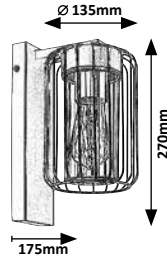

77108

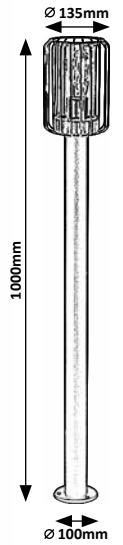

77107

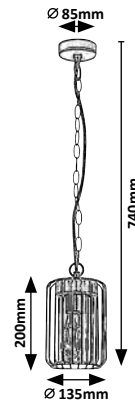

77106 (M) (P)

⊗ E27 / 1x max. 40W
IP44
20029
black/transparent



5 996595 771065

77107 (M) (P)

⊗ E27 / 1x max. 40W
IP44
20029
black/transparent



5 996595 771072

77108 (M) (P)

⊗ E27 / 1x max. 40W
IP44
20029
black/transparent



5 996595 771089

HAREN



77083

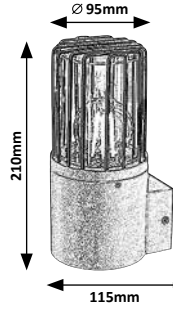

77084

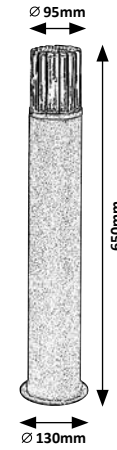

77083



SAVANO



7266

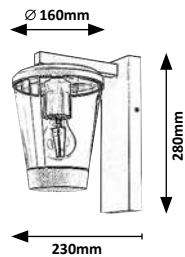

7267

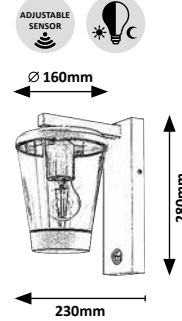

7267



77083 (M) (P)

☒ E27 / 1x max. 60W
IP54 • 20052
black/transparent



5 996595 770839

77084 (M) (P)

☒ E27 / 1x max. 60W
IP54 • 20052
black/transparent



5 996595 770846

7266 (M) (P)

☒ E27 / 1x max. 40W
IP44 • 19178
anthracite/transparent



5 998250 372662

7267 (M) (P)

☒ E27 / 1x max. 40W
IP44 • 19178
8±2m, 120°
anthracite/transparent



5 998250 372679

PARAVENTO



7146

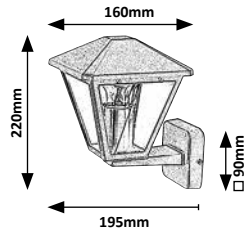

7147

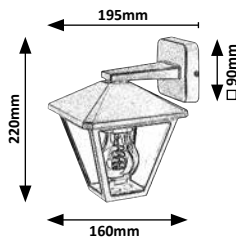

7148

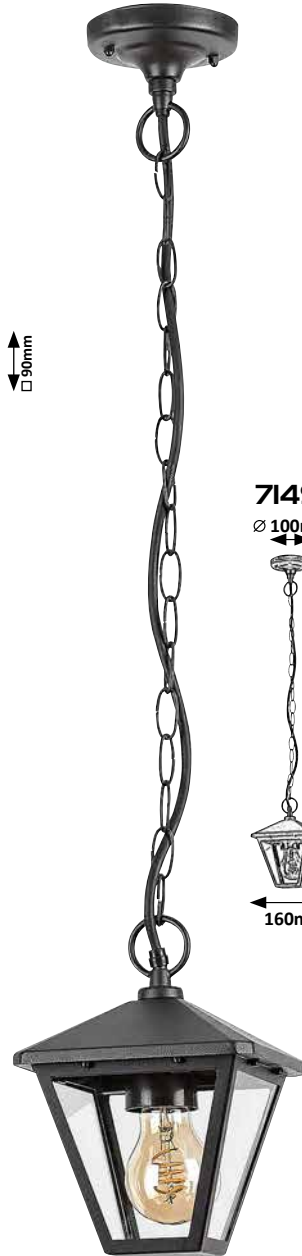
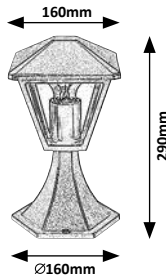

7149

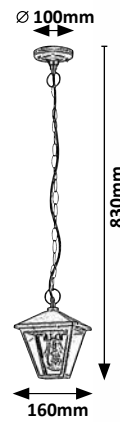

7150

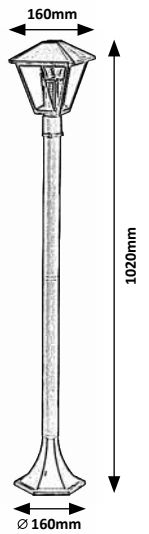

7146 (M) (G)

☒ E27 / 1x max. 40W
IP44 • 19275
black/transparent



5 998250 371467

7147 (M) (G)

☒ E27 / 1x max. 40W
IP44 • 19275
black/transparent



5 998250 371474

7148 (M) (G)

☒ E27 / 1x max. 40W
IP44 • 19275
black/transparent



5 998250 371481

7149 (M) (G)

☒ E27 / 1x max. 40W
IP44 • 19275
black/transparent



5 998250 371498

7150 (M) (G)

☒ E27 / 1x max. 40W
IP44 • 19275
black/transparent



5 998250 371504

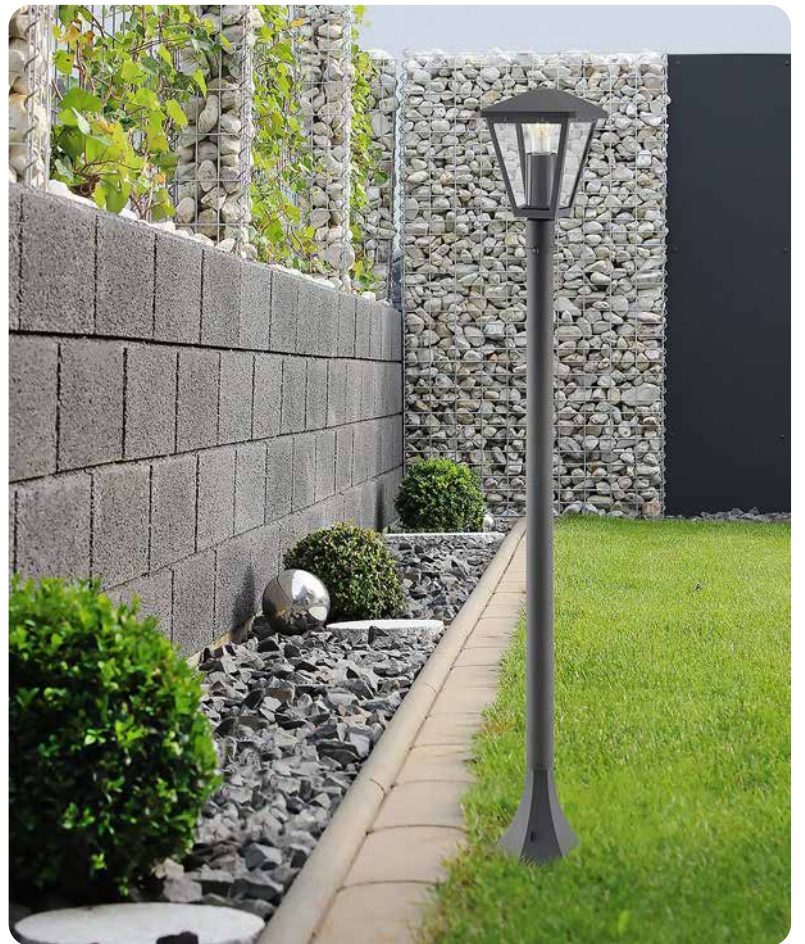



TAVERNA

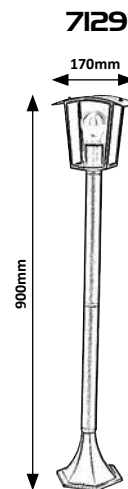
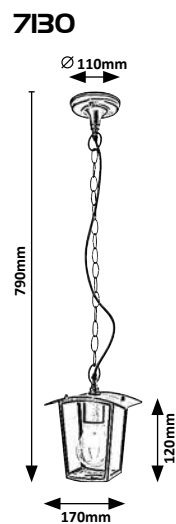
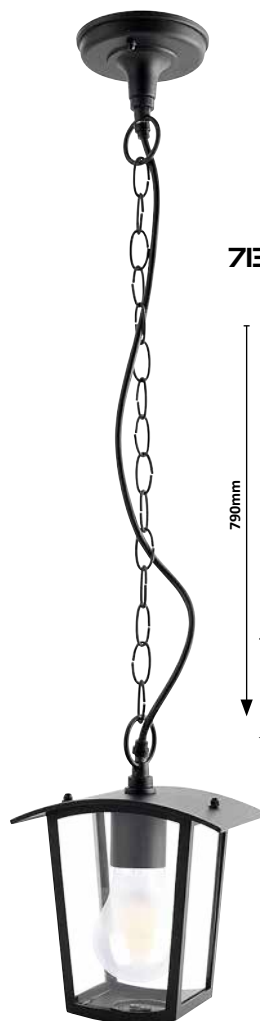
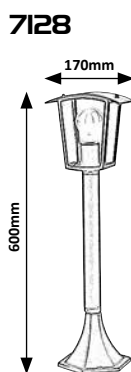
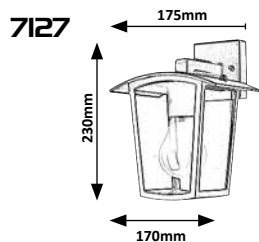

7127 (M) (P)

☒ E27 / 1x max. 15W
IP44 • 19983
black/transparent



7128 (M) (P)

☒ E27 / 1x max. 15W
IP44 • 19983
black/transparent



7129 (M) (P)

☒ E27 / 1x max. 15W
IP44 • 19983
black/transparent



7130 (M) (P)

☒ E27 / 1x max. 15W
IP44 • 19983
black/transparent



DUBROVNIK

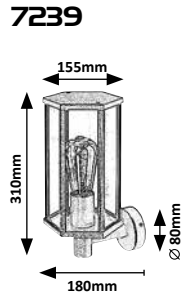
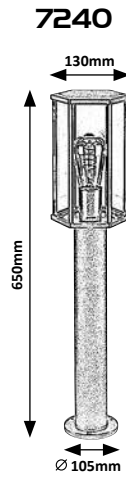
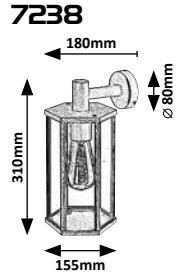

7238 (M) (G)

☒ E27 / 1x max. 40W
IP44 • 19166
matte black/transparent



5 998250 372389

7239 (M) (G)

☒ E27 / 1x max. 40W
IP44 • 19166
matte black/transparent



5 998250 372396

7240 (M) (G)

☒ E27 / 1x max. 40W
IP44 • 19166
matte black/transparent



5 998250 372402

ALMADA

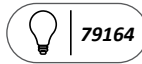

7884

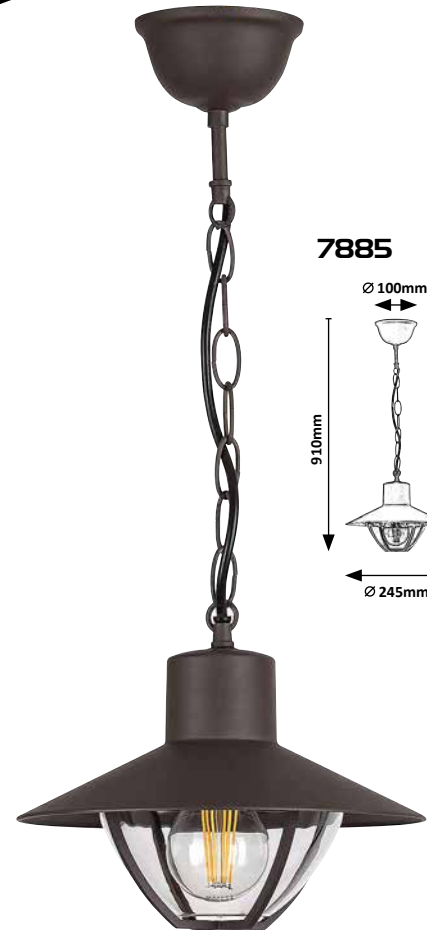
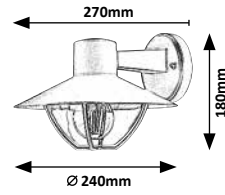

7885

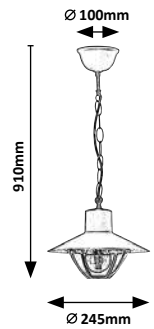

7884 (M) (P)

☒ E27 / 1x max. 10W
IP44 • 19855
brown/transparent



5 998250 378848

7885 (M) (P)

☒ E27 / 1x max. 10W
IP44 • 19855
brown/transparent



5 998250 378855

BUDAPEST



8888

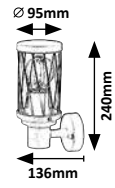

8890

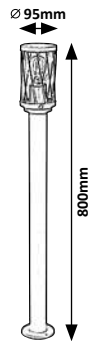

8889

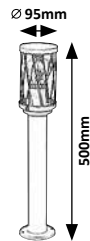

8888 (M) (P)

☒ E27 / 1x max. 40W
IP44
brown/transparent



5 998250 388885

8889 (M) (P)

☒ E27 / 1x max. 40W
IP44
brown/transparent



5 998250 388892

8890 (M) (P)

☒ E27 / 1x max. 40W
IP44
brown/transparent



5 998250 388908



BLACK TORCH



8145



8146

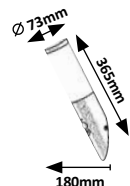

8146



8147

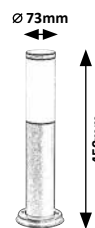

8147



8148

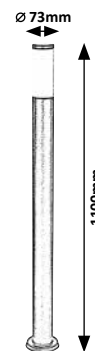

8145 (M) (P)

☒ E27 / 1x max. 25W
IP44 • 19607
matte black/white



5 998250 381459

8146 (M) (P)

☒ E27 / 1x max. 25W
IP44 • 19607
0-5m, 100°
matte black/white



5 998250 381466

8147 (M) (P)

☒ E27 / 1x max. 25W
IP44 • 19607
matte black/white



5 998250 381473

8148 (M) (P)

☒ E27 / 1x max. 25W
IP44 • 19607
matte black/white



5 998250 381480

BONN



8337

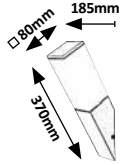

8338

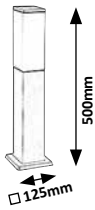

8339

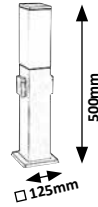

8337 (M) (P)

☒ E27 / 1x max. 60W
IP44 • 19130
matte black/white



5 998250 383378

8338 (M) (P)

☒ E27 / 1x max. 60W
IP44 • 19130
matte black/white



5 998250 383385

8339 (M) (P)

☒ E27 / 1x max. 60W
IP44 • 19130
matte black/white



5 998250 383392

INOX TORCH

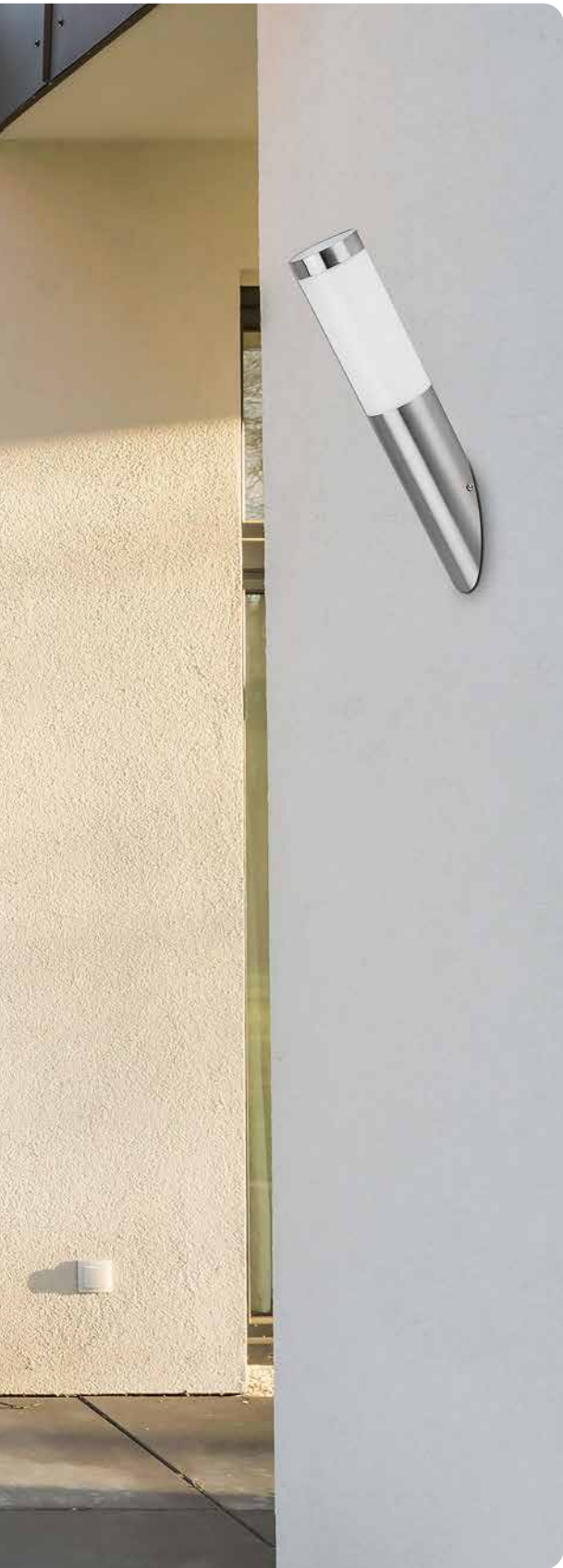

8261 (M) (P)

☒ E27 / 1x max. 25W
IP44 • 9437
satin chrome/white



8263 (M) (P)

☒ E27 / 1x max. 25W
IP44 • 9437
satin chrome/white



8264 (M) (P)

☒ E27 / 1x max. 25W
IP44 • 9437
satin chrome/white



INOX TORCH



8266

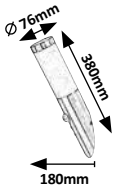

8268



Ø 76mm

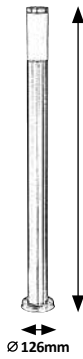

8265

Ø 76mm

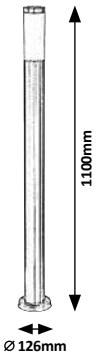

8267



Ø 76mm

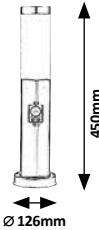

8265 (M) (P)

☒ E27 / 1x max. 25W
IP44 • 9437
satin chrome/white



5 998250 382654

8266 (M) (P)

☒ E27 / 1x max. 25W
IP44 • 9437
☒ 0-5m, 100°
satin chrome/white



5 998250 382661

8267 (M) (P)

☒ E27 / 1x max. 25W
IP44 • 9437
☒ 0-5m, 100°
satin chrome/white



5 998250 382678

8268 (M) (P)

☒ E27 / 1x max. 25W
IP44 • 9437
☒ 0-5m, 100°
satin chrome /white



5 998250 382685

LISBON



7826

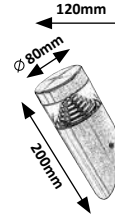

7827

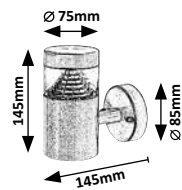

7828

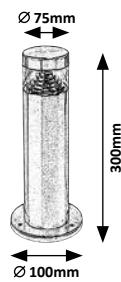

7829

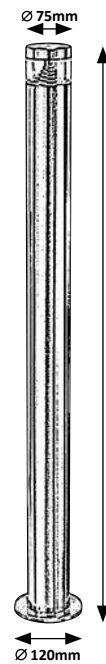

7826 (M) (P)

LED / 7W
(560lm, 4000K) incl.
IP54
stainless steel/transparent



5 998250 378268

7827 (M) (P)

LED / 7W
(560lm, 4000K) incl.
IP54
stainless steel/transparent



5 998250 378275

7828 (M) (P)

LED / 7W
(560lm, 4000K) incl.
IP54
stainless steel/transparent



5 998250 378282

7829 (M) (P)

LED / 7W
(560lm, 4000K) incl.
IP54
stainless steel/transparent



5 998250 378299



02

WALL AND CEILING LAMPS

FALI- ÉS MENNYEZETLÁMPÁK

WAND- UND DECKENLAMPEN



77050



TILBURG



77049

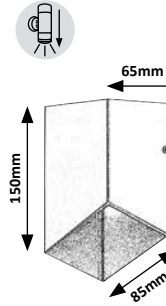

77050

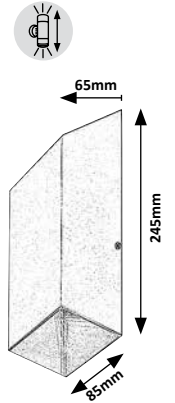

77051



OGNON



77051

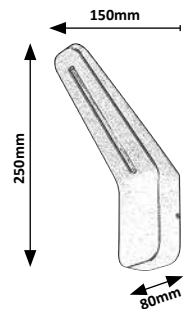

77049 (M) (G)

LED / 5W
(160lm, 550lm;
3000K) incl. • IP54
anthracite/transparent



5 996595 770495

77050 (M) (G)

LED / 10W
(350lm, 1150lm;
3000K) incl. • IP54
anthracite/transparent



5 996595 770501

77051 (M) (P)

LED / 8W
(500lm, 950lm;
3000K) incl. • IP54
anthracite/white



5 996595 770518

TEMSE



77065

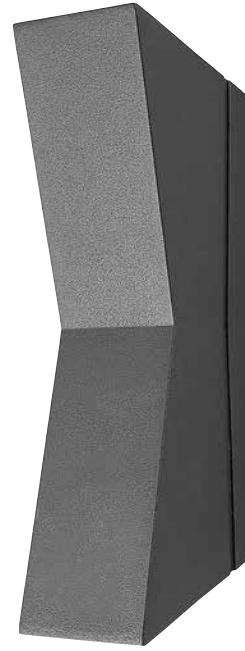
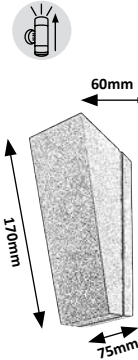

77066

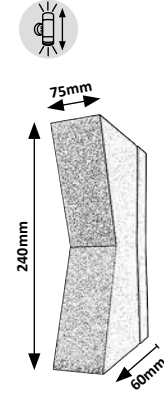

NAVIA



8130

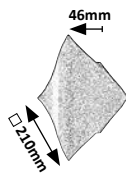

FOLLINA



8154

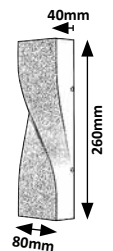

77065 (M) (P)

LED / 3W
(140lm, 280lm;
4000K) incl. • IP65
anthracite/transparent



5 996595 770655

77066 (M) (P)

LED / 6W
(290lm, 560lm;
4000K) incl. • IP65
anthracite/transparent



5 996595 770662

8130 (M)

LED / 11W
(64lm, 4000K) incl.
IP65
black



5 998250 381305

8154 (M)

LED / 11W
(530lm, 4000K) incl.
IP65
black



5 998250 381541



RUST



77151



LED / 15W
 (1500lm, 1700lm;
 2700K, 4000K, 6500K) incl. • IP65
 black



5 996595 771515

77152



LED / 15W
 (1500lm, 1700lm;
 2700K, 4000K, 6500K) incl. • IP65
 grey



5 996595 771522

77153



LED / 15W
 (1500lm, 1700lm;
 2700K, 4000K, 6500K) incl. • IP65
 brown



5 996595 771539

HALLSTATT



77168

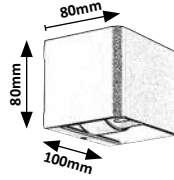

77169

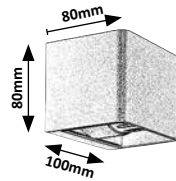

77170

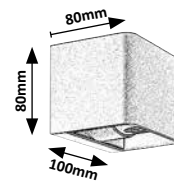

77168, 77169, 77170

INDIRECT



77168 **M G**

LED / 10W
 (320lm, 1100lm;
 3000K) incl. • IP54
 antrachite/transparent



5 996595 771683

77169 **M G**

LED / 10W
 (320lm, 1100lm;
 3000K) incl. • IP54
 brown/transparent



5 996595 771690

77170 **M G**

LED / 10W
 (360lm, 1100lm;
 3000K) incl. • IP54
 grey/transparent



5 996595 771706

7396, 7397



SOLIN



7396

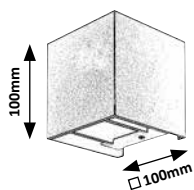

7397

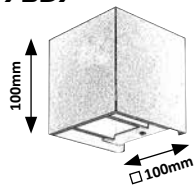

KELEBIA



77125

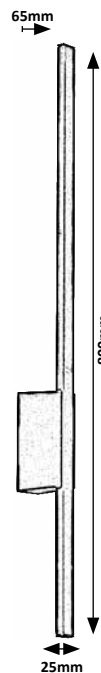

7396 (M) (P)

G9 / 1x max. 5W
IP54
matte black



5 998250 373966

7397 (M) (P)

G9 / 1x max. 5W
IP54
matte white



5 998250 373973

77125 (M) (P)

LED / 12W
(1000lm, 1200lm;
3000K) incl. • IP44
black/white



5 996595 771256

LIPPA

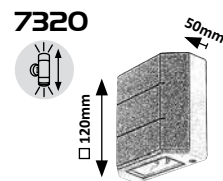
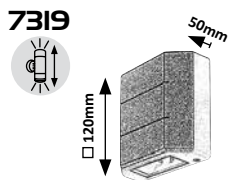
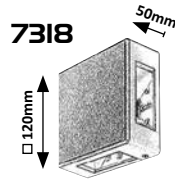
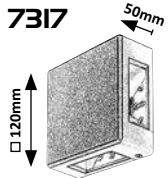

7317, 7318

INDIRECT



7319, 7320

INDIRECT



7317 (P)

LED / 6W
(190lm, 3000K) incl.
IP54
black



5 998250 373171

7318 (P)

LED / 6W
(360lm, 3000K) incl.
IP54
white



5 998250 373188

7319 (P)

LED / 6W
(70lm, 3000K) incl.
IP54
black



5 998250 373195

7320 (P)

LED / 6W
(150lm, 3000K) incl.
IP54
white



5 998250 373201

8873

INDIRECT



NESNA

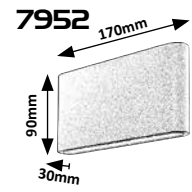
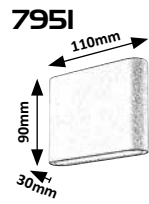

8874

INDIRECT



MARIBOR

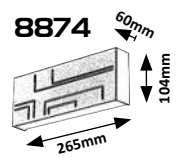
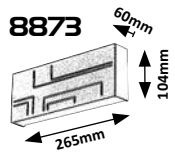
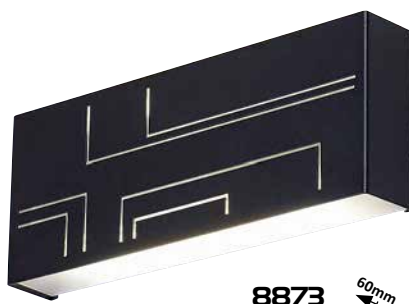
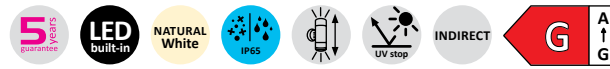

7951 (M G)

LED / 6W
(386lm, 3000K) incl.
IP54 • 19626
anthracite/opal glass



7952 (M G)

LED / 12W
(528lm, 3000K) incl.
IP54 • 19630
anthracite/opal glass



8873 (M P)

LED / 12W
(780lm, 4000K) incl.
IP65
black/white



8874 (M P)

LED / 12W
(780lm, 4000K) incl.
IP65
white



HULST

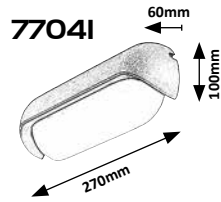

BIRMINGHAM

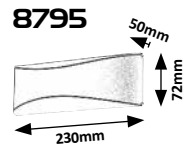

MATARO

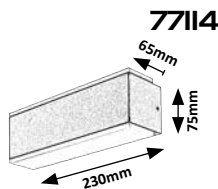

IBAR



KOBARID

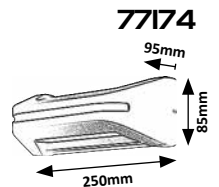

7704I (M P)

LED / 13W
 (850lm, 1500lm;
 3000K) incl. • IP65
 anthracite/white



5 996595 770419

8795 (M P)

LED / 7W
 (796lm, 4000K) incl.
 IP65
 anthracite/white



5 998250 387956

77114 (M P)

LED / 12W
 (950lm, 1200lm;
 3000K) incl. • IP54
 black/white



5 996595 771140

77109 (M P)

LED / 3W
 (250lm, 300lm;
 3000K) incl. • IP54
 black/transparent



5 996595 771096

77174 (M P)

LED / 20W
 (800lm, 2300lm;
 4000K) incl. • IP54
 black/white



5 996595 771744

GIMONE



77097

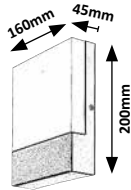

77098

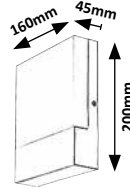

RENNES



77042

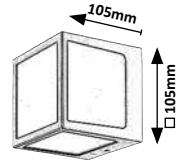

ANDELLE



77095

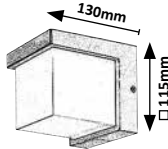

77096

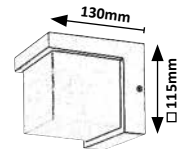

77097



LED / 10W
 (570lm, 1000lm;
 4000K) incl. • IP44
 black/white



5 996595 770976

77098



LED / 10W
 (660lm, 1000lm;
 4000K) incl. • IP44
 white



5 996595 770983

77095



LED / 10W
 (500lm, 1000lm;
 3000K) incl. • IP54
 black/white



5 996595 770952

77096



LED / 10W
 (570lm, 1000lm;
 3000K) incl. • IP54
 white



5 996595 770969

77042



LED / 10W
 (580lm, 1000lm;
 4000K) incl. • IP54
 anthracite/white



5 996595 770426

ZARAGOZA



77092

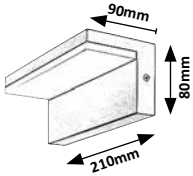

77093

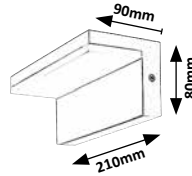

77115

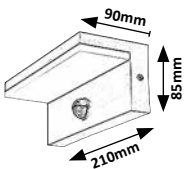

77116

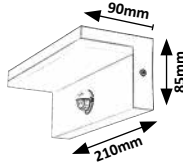

77115, 77116



77092



LED / 10W
(8560lm, 10000lm;
4000K) incl. • IP54
black/white



5 996595 770921

77093



LED / 10W
(780lm, 10000lm;
4000K) incl. • IP54
white



5 996595 770938

77115



LED / 9W
(800lm, 10000lm;
2700K, 4000K, 6500K) incl. • IP54
6-8m, 110° • black/white



5 996595 771157

77116



LED / 9W
(850lm, 10000lm;
2700K, 4000K, 6500K) incl. • IP54
6-8m, 110° • white



5 996595 771164

BALIMO



7477

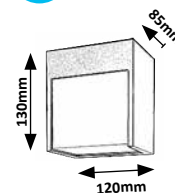

7476

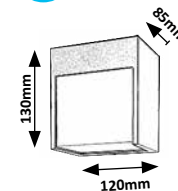

7479

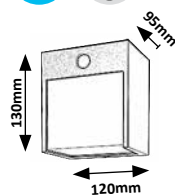

7478

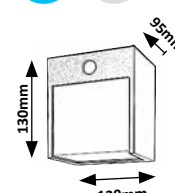

7476 (M P)

LED / 12W
(560lm, 4000K) incl.
IP54
matte black/white



5 998250 374765

7477 (M P)

LED / 12W
(560lm, 4000K) incl.
IP54
matte white/white



5 998250 374772

7478 (M P)

LED / 12W
(560lm, 4000K) incl.
IP44 • 7m, 106°
matte black/white



5 998250 374789

7479 (M P)

LED / 12W
(560lm, 4000K) incl.
IP44 • 7m, 106°
matte white/white



5 998250 374796

BATIDA



77117

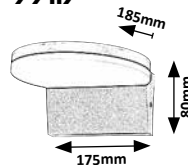

77118

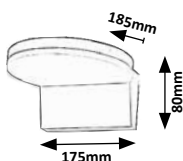

77119

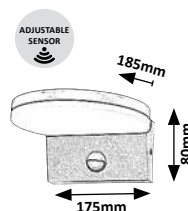

77120

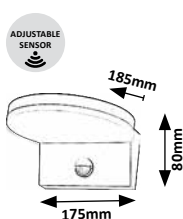

77117, 77118, 77119, 77120



77117



LED / 9W
 (9900lm, 10000lm;
 2700K, 4000K, 6500K) incl. • IP54
 black/white



5 996595 771171

77118



LED / 9W
 (9500lm, 10000lm;
 2700K, 4000K, 6500K) incl. • IP54
 white



5 996595 771188

77119



LED / 9W
 (9900lm, 10000lm;
 2700K, 4000K, 6500K) incl. • IP54
 6-8m, 110° • black/white



5 996595 771195

77120



LED / 9W
 (9500lm, 10000lm;
 2700K, 4000K, 6500K) incl. • IP54
 6-8m, 110° • white



5 996595 771201



VARNA



8134



8135



BONA



8060

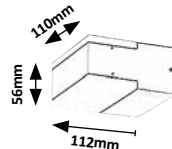

HALDEN



7935

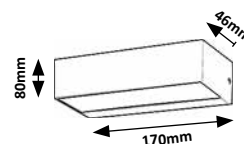

8134



LED / 12W
(720lm, 4000K) incl.
IP54
black/white



5 998250 381343

8135



LED / 12W
(720lm, 4000K) incl.
IP54 • 8m, 120°
black/white



5 998250 381350

8060



LED / 9W
(678lm, 4000K) incl.
IP54
anthracite/white



5 998250 380605

7935



LED / 9W
(640lm, 4000K) incl.
IP65
black/white



5 998250 379357

SENICA

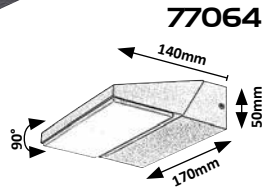

77064



LAXA

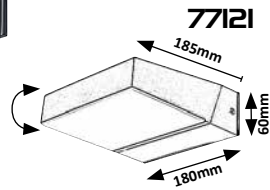

77121



RAPLA 2

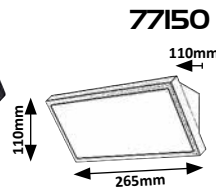

77150

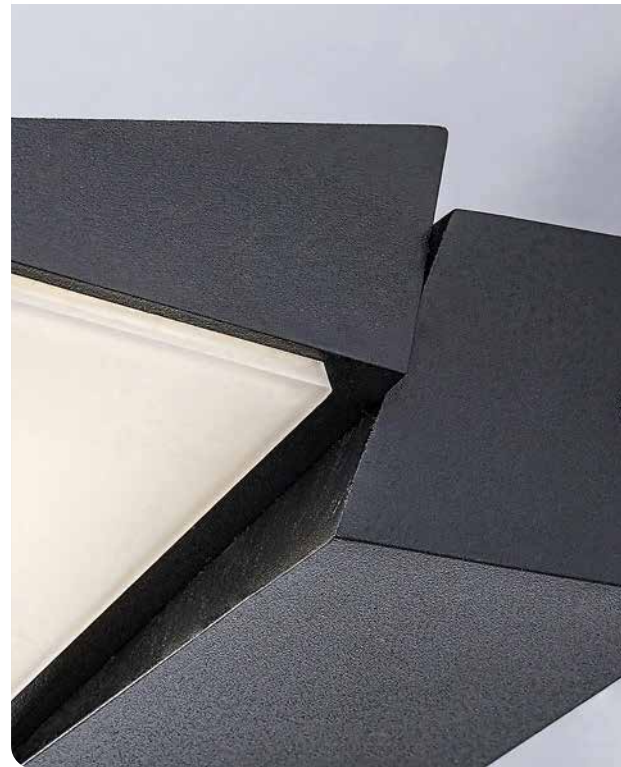

77064 (M) (P)

LED / 13W
 (☉)540lm, (☉)1450lm;
 4000K) incl. • IP65
 black/white



5 996595 770648

77121 (P)

LED / 14W
 (☉)1400lm, (☉)1500lm;
 2700K, 4000K, 6500K) incl. • IP54
 black/white



5 996595 771218

77150 (P)

LED / 18W
 (☉)1700lm, (☉)1900lm;
 2700K, 4000K, 6500K) incl. • IP65
 black/white



5 996595 771508

MATARO



77073 (M G)

LED / 7W
 (430lm, 800lm;
 4000K) incl. • IP54
 black/white



5 996595 770730

77074 (M G)

LED / 7W
 (580lm, 800lm;
 4000K) incl. • IP54
 white



5 996595 770747

77075 (M G)

LED / 10W
 (720lm, 1200lm;
 4000K) incl. • IP54
 black/white



5 996595 770754

77076 (M G)

LED / 10W
 (970lm, 1200lm;
 4000K) incl. • IP54
 white



5 996595 770761

MANDAL

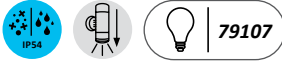

7959

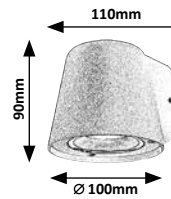

7960

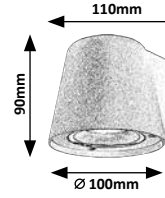

BUFFALO



7887

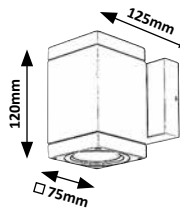

7888

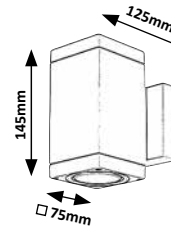

7959 **MG**

☒ GU10 / 1x max. 35W
IP54
matte black/transparent



5 998250 379593

7960 **MG**

☒ GU10 / 1x max. 35W
IP54
matte white/transparent



5 998250 379609

7887 **MG**

☒ GU10 / 1x max. 35W
IP54
anthracite/transparent



5 998250 378879

7888 **MG**

☒ GU10 / 2x max. 35W
IP54
anthracite/transparent



5 998250 378886

77154, 77155, 77156, 77157



URFA



77154



77155

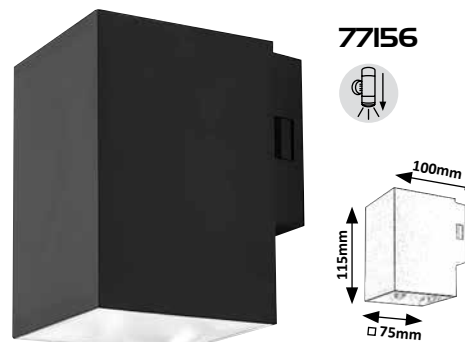

77156

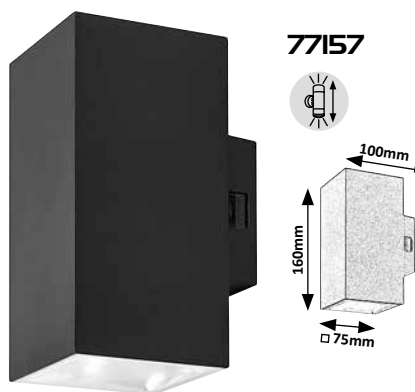

77157

77154



LED / 9W
 (9900lm, 9990lm;
 2700K, 4000K, 6500K) incl. • IP65
 black



5 996595 771546

77155



LED / 18W
 (1800lm, 1980lm;
 2700K, 4000K, 6500K) incl. • IP65
 black



5 996595 771553

77156



LED / 9W
 (900lm, 990lm;
 2700K, 4000K, 6500K) incl. • IP65
 black



5 996595 771560

77157



LED / 18W
 (1800lm, 1980lm;
 2700K, 4000K, 6500K) incl. • IP65
 black



5 996595 771577

URFA



77162

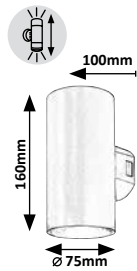

77161

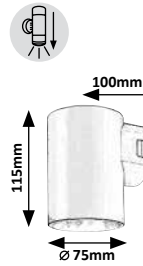

77164

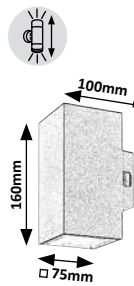

77163

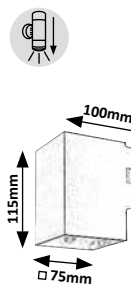

77161, 77162, 77163, 77164



77161



LED / 9W
(9900lm, 9990lm;
2700K, 4000K, 6500K) incl. • IP65
white



5 996595 771614

77162



LED / 18W
(1800lm, 1980lm;
2700K, 4000K, 6500K) incl. • IP65
white



5 996595 771621

77163



LED / 9W
(9900lm, 9990lm;
2700K, 4000K, 6500K) incl. • IP65
white



5 996595 771638

77164



LED / 18W
(1800lm, 1980lm;
2700K, 4000K, 6500K) incl. • IP65
white



5 996595 771645



MEDINA

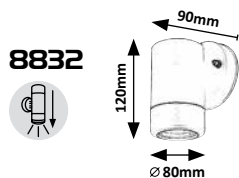

8832



8834

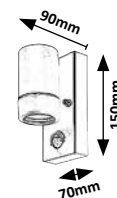

8833



8835

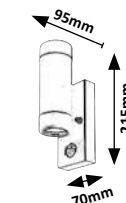

8832



☒ GU10 / 1x max. 10W
IP44
matte black/transparent



8833



☒ GU10 / 2x max. 10W
IP44
matte black/transparent



8834



☒ GU10 / 1x max. 10W
IP44
☒ 2-8m, 90°
matte black/transparent



8835



☒ GU10 / 2x max. 10W
IP44
☒ 2-8m, 90°
matte black/transparent



CHILE



8020

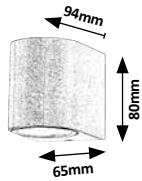

8029

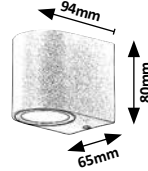

8018

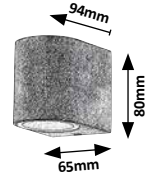

8034

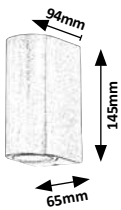

8030

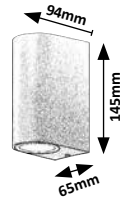

8019

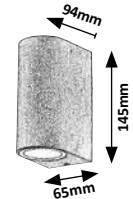

8020 **M G**

☒ GU10 / 1x max. 35W
IP44
brushed aluminium



5 998250 380209

8034 **M G**

☒ GU10 / 2x max. 35W
IP44
brushed aluminium



5 998250 380346

8029 **M G**

☒ GU10 / 1x max. 35W
IP44
black



5 998250 380292

8030 **M G**

☒ GU10 / 2x max. 35W
IP44
black



5 998250 380308

8018 **M G**

☒ GU10 / 1x max. 35W
IP44
antique brown



5 998250 380186

8019 **M G**

☒ GU10 / 2x max. 35W
IP44
antique brown



5 998250 380193



SINTRA



7955

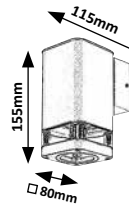

7956

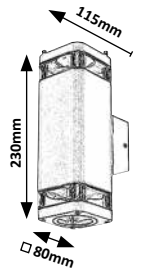

PHOENIX



8118



8119

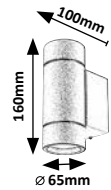

7955 (M P)

☒ GU10 / 1x max. 25W
IP44
matte black/transparent



5 998250 379555

7956 (M P)

☒ GU10 / 2x max. 25W
IP44
matte black/transparent



5 998250 379562

8118 (M G)

☒ GU10 / 1x max. 10W
IP54 • 19625
anthracite/transparent



5 998250 381183

8119 (M G)

☒ GU10 / 2x max. 10W
IP54 • 19625
anthracite/transparent



5 998250 381190

NOVIGRAD



7236

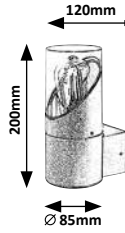

7237

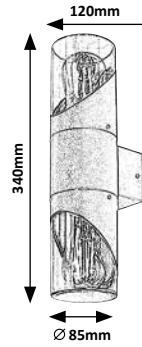

ORLOVA



SILISTRA



7892

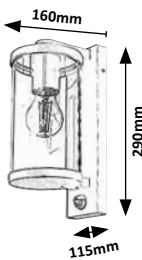

7891

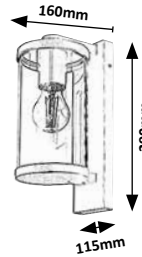

7244

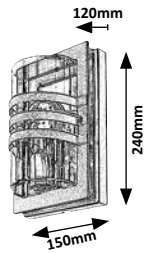

7236 (M P)

☒ E27 / 1x max. 28W
IP54 • 19168
black/transparent



5 998250 372365

7237 (M P)

☒ E27 / 2x max. 28W
IP54 • 19168
black/transparent



5 998250 372372

7891 (M G)

☒ E27 / 1x max. 60W
IP44 • 19852
anthracite/transparent



5 998250 378916

7892 (M G)

☒ E27 / 1x max. 60W
IP44 • 19852
☒ 1-12m, 110°
anthracite/transparent



5 998250 378923

7244 (M P)

☒ E27 / 1x max. 40W
IP44 • 19177
black/transparent



5 998250 372440

MENDOZA

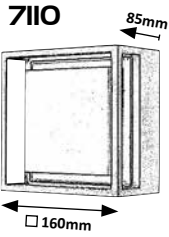
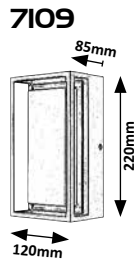

LUBLIN

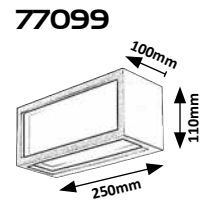
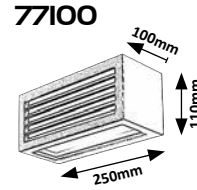

7109 (M P)

LED / 6,5W
(550lm, 3000K) incl.
IP65
anthracite/white



7110 (M P)

LED / 6,5W
(530lm, 3000K) incl.
IP65
anthracite/white



77099 (M P)

LED / 10W
(480lm, 1000lm; 4000K) incl.
IP54 • 20053
black/white



77100 (M P)

LED / 10W
(480lm, 1000lm; 4000K) incl.
IP54 • 20053
black/white



MANHATTAN

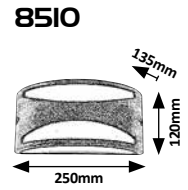
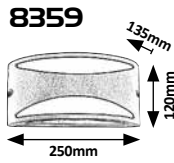

OPOLE

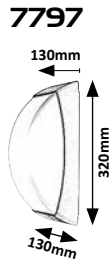
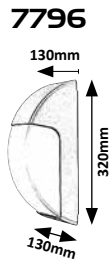

GENDT

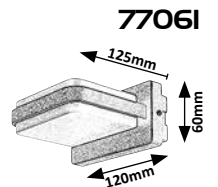

7796 (P)

☒ E27 / 1x max. 12W
IP65
matte black/white



5 998250 377964

7797 (P)

☒ E27 / 1x max. 12W
IP65
matte black/white



5 998250 377971

8359 (M P)

☒ E27 / 1x max. 60W
IP54
matte black/white



5 998250 383590

8510 (M P)

☒ E27 / 1x max. 60W
IP54
antique gold/white



5 998250 385105

7706I (M P)

☑ LED / 12W
(800lm, 1300lm;
3000K) incl. • IP44
black/white



5 996595 770617

ROMA



8409

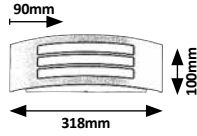

8511

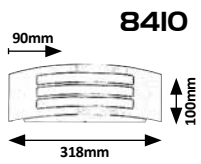
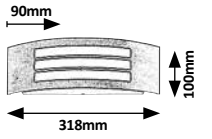

8410

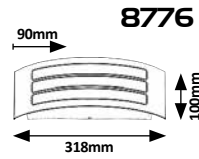

8776



8409 (M) (P)

☒ E27 / 1x max. 14W
IP44
matte black/white



5 998250 384092

8410 (M) (P)

☒ E27 / 1x max. 14W
IP44
satin chrome/white



5 998250 384108

8511 (M) (P)

☒ E27 / 1x max. 14W
IP44
antique gold/white



5 998250 385112

8776 (M) (P)

☒ E27 / 1x max. 14W
IP44
anthracite/white



5 998250 387765

SEATTLE



8169

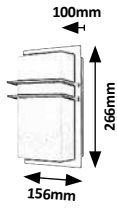

8229

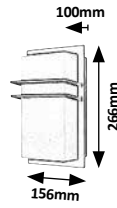

RODEZ



8940

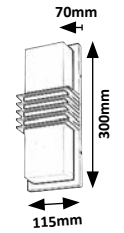

SEVILLA



8799

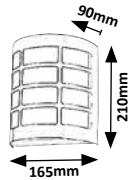

8800

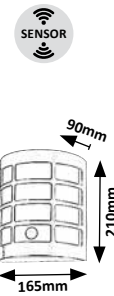

8169 (M P)

☒ E27 / 1x max. 11W
IP44
black/white



5 998250 381695

8229 (M P)

☒ E27 / 1x max. 11W
IP44
satin chrome/white



5 998250 382296

8940 (M P)

☒ LED / 12W
(800lm, 4000K) incl.
IP44
anthracite/white



5 998250 389400

8799 (M P)

☒ E27 / 1x max. 11W
IP44
satin chrome/white



5 998250 387994

8800 (M P)

☒ E27 / 1x max. 11W
IP44 • ☒ 0-5m, 100°
satin chrome/white



5 998250 388007

ZOMBOR

AKRON

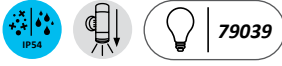

7817

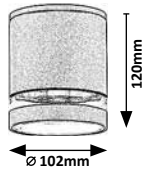

7818

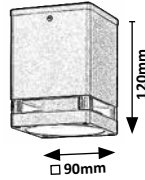

8149

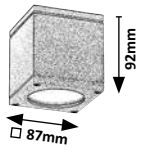

7819

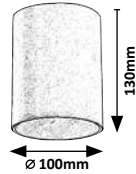

7820

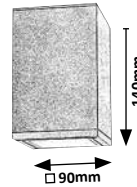

8150

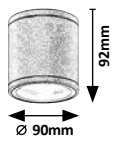

7817 (M P)
 ☒ GU10 / 1x max. 35W
 IP54
 anthracite/transparent



7818 (M P)
 ☒ GU10 / 1x max. 35W
 IP54
 anthracite/transparent



7819 (M G)
 ☒ GU10 / 1x max. 35W
 IP54
 anthracite/opal glass



7820 (M G)
 ☒ GU10 / 1x max. 35W
 IP54
 anthracite/opal glass



8149 (M G)
 ☒ GU10 / 1x max. 35W
 IP54
 anthracite/transparent



8150 (M G)
 ☒ GU10 / 1x max. 35W
 IP54
 anthracite/transparent



KOVEN



79079



New



71342

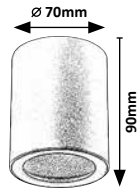

71343

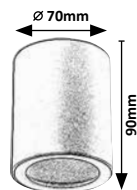

COCO



5274

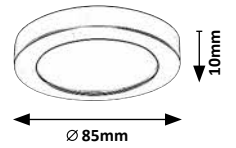

5275

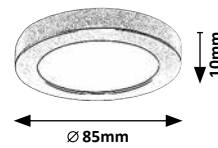

5276

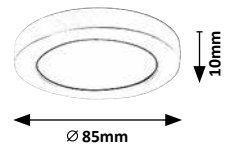

71342

M G

☒ GU10 / 1x max. 35W
IP44
black



5 996595 713423

71343

M G

☒ GU10 / 1x max. 35W
IP44
white



5 996595 713430

5274

P

☒ LED / 3W
☒ 220lm; ☒ 400lm, 4000K) incl.
IP44 • ↓ 25mm
black/white



5 998250 352749

5275

P

☒ LED / 3W
☒ 230lm; ☒ 400lm, 4000K) incl.
IP44 • ↓ 25mm
silver/white



5 998250 352756

5276

P

☒ LED / 3W
☒ 250lm; ☒ 400lm, 4000K) incl.
IP44 • ↓ 25mm
white



5 998250 352763



INVERNESS

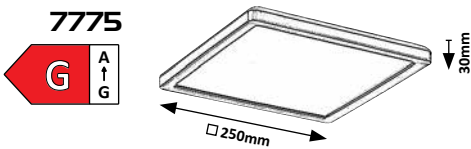
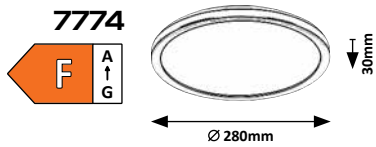

7774, 7775

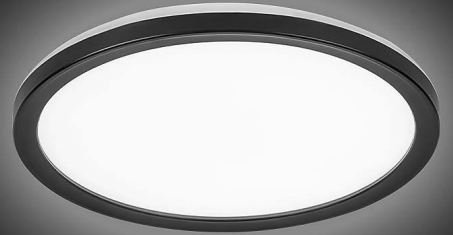

7774

(P)

LED / 15W
(1300lm, 2700K-6500K) incl.
IP44 • 555
black/white



5 998250 377742

7775

(P)

LED / 15W
(1190lm, 2700K-6500K) incl.
IP44 • 555
black/white



5 998250 377759

7893, 7894, 7895, 7896

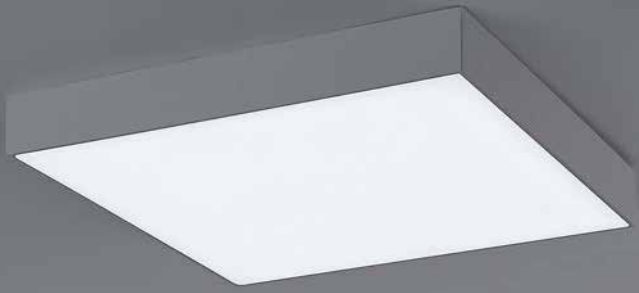
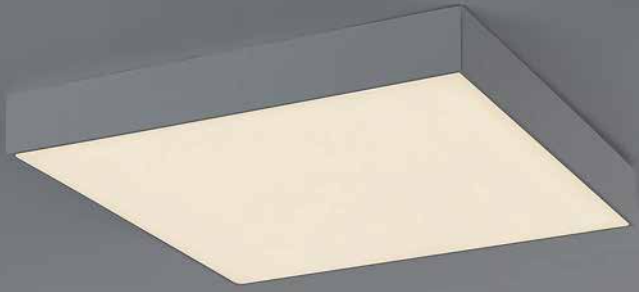
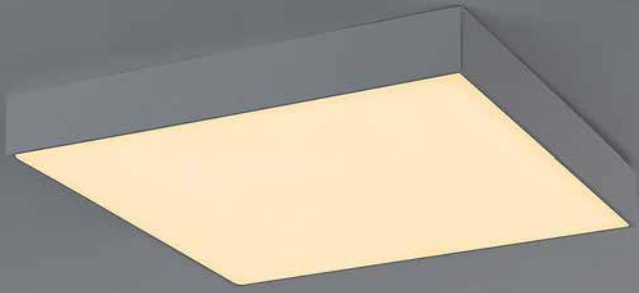

TARTU



7893

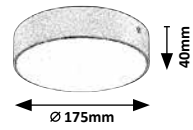

7894

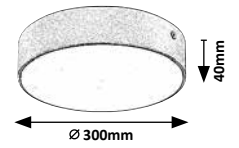

7895

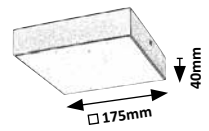

7896

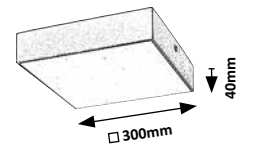

7893 (M P)

LED / 18W (1800lm, 2800K, 4000K, 6000K) incl. IP44 matte white/white



5 998250 378930

7894 (M P)

LED / 24W (2500lm, 2800K, 4000K, 6000K) incl. IP44 matte white/white



5 998250 378947

7895 (M P)

LED / 18W (1800lm, 2800K, 4000K, 6000K) incl. IP44 matte white/white



5 998250 378954

7896 (M P)

LED / 24W (2500lm, 2800K, 4000K, 6000K) incl. IP44 matte white/white



5 998250 378961

TARTU



7897

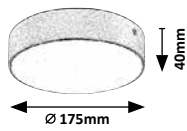

7898

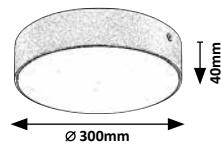

7899

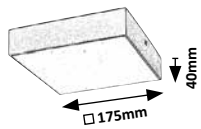

7900

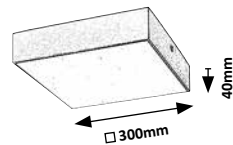

7897, 7898, 7899, 7900



7897 (M) (P)

LED / 18W (1800lm, 2800K, 4000K, 6000K) incl. IP44

matte black/white



5 998250 378978

7898 (M) (P)

LED / 24W (2500lm, 2800K, 4000K, 6000K) incl. IP44

matte black/white



5 998250 378985

7899 (M) (P)

LED / 18W (1800lm, 2800K, 4000K, 6000K) incl. IP44

matte black/white



5 998250 378992

7900 (M) (P)

LED / 24W (2500lm, 2800K, 4000K, 6000K) incl. IP44

matte black/white



5 998250 379005

77133, 77134, 77135, 77136, 77181, 77182

DIP SWITCH



LOWAR



77133

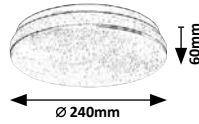

77182

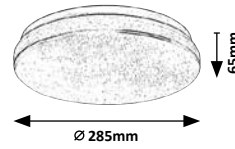

77135

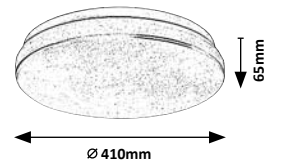

77134



77181

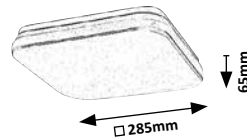

77136

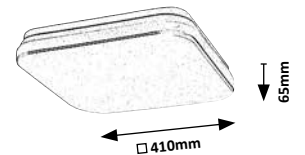

77133



LED / 12W
 (☰) 750lm; (☲) 1200lm,
 3000K, 4000K, 6000K) incl.
 IP44 • white



5 996595 771331

77134



LED / 12W
 (☰) 750lm; (☲) 1200lm,
 3000K, 4000K, 6000K) incl.
 IP44 • white



5 996595 771348

77135



LED / 36W
 (☰) 2300lm; (☲) 3600lm,
 3000K, 4000K, 6000K) incl.
 IP44 • white



5 996595 771355

77136



LED / 36W
 (☰) 2300lm; (☲) 3600lm,
 3000K, 4000K, 6000K) incl.
 IP44 • white



5 996595 771362

77181



LED / 18W
 (☰) 1100lm; (☲) 1800lm,
 3000K, 4000K, 6000K) incl.
 IP44 • white



5 996595 771812

77182



LED / 18W
 (☰) 1100lm; (☲) 1800lm,
 3000K, 4000K, 6000K) incl.
 IP44 • white



5 996595 771829

ZENON

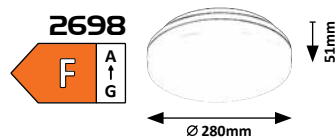
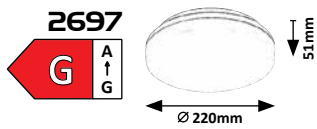

INDRE

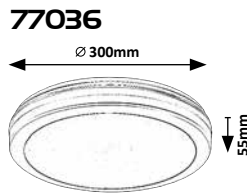
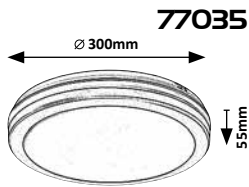

2697, 2698



2697 (P)

LED / 18W
 (E) 1450lm; (E) 1880lm,
 3000K, 4000K, 6000K) incl.
 IP54 • white



5 998250 326979

2698 (P)

LED / 24W
 (E) 2100lm; (E) 2565lm,
 3000K, 4000K, 6000K) incl.
 IP54 • white



5 998250 326986

77035 (P)

LED / 28W
 (E) 2450lm, (E) 3450lm;
 3000K, 4000K, 6500K) incl. • IP54
 black/white



5 996595 770358

77036 (P)

LED / 28W
 (E) 2600lm, (E) 3450lm;
 3000K, 4000K, 6500K) incl. • IP54
 white



5 996595 770365



ALENZO



71425

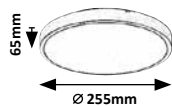

71426

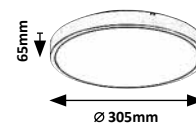

71435

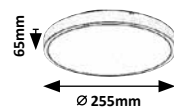

71436

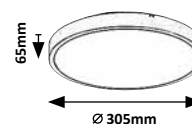

71425



LED / 12W
 (790lm, 1200lm;
 3000K, 4000K, 6000K) incl.
 IP44 • white



5 996595 714253

71426



LED / 18W
 (1250lm, 1800lm;
 3000K, 4000K, 6000K) incl.
 IP44 • white



5 996595 714260

71435



LED / 12W
 (780lm, 1200lm;
 3000K, 4000K, 6000K) incl.
 IP44 • black/white



5 996595 714352

71436



LED / 18W
 (1200lm, 1800lm;
 3000K, 4000K, 6000K) incl.
 IP44 • black/white



5 996595 714368

ALENZO



71427

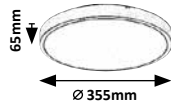

71429

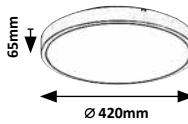

71437

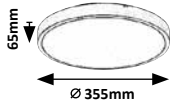

71439

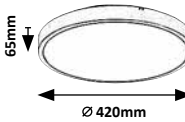

71427



LED / 24W
 (1600lm, 2400lm;
 3000K, 4000K, 6000K) incl.
 IP44 • white



5 996595 714277

71429



LED / 36W
 (2450lm, 3600lm;
 3000K, 4000K, 6000K) incl.
 IP44 • white



5 996595 714291

71437



LED / 24W
 (1500lm, 2400lm;
 3000K, 4000K, 6000K) incl.
 IP44 • black/white



5 996595 714376

71439



LED / 36W
 (2300lm, 3600lm;
 3000K, 4000K, 6000K) incl.
 IP44 • black/white



5 996595 714390

71422, 71423, 71432, 71433



ALENZO



71422



71423

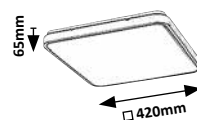

71432

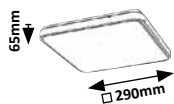

71433

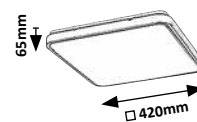

71422



LED / 24W
 (1600lm, 2400lm;
 3000K, 4000K, 6000K) incl.
 IP44 • white



5 996595 714222

71423



LED / 36W
 (2350lm, 3600lm;
 3000K, 4000K, 6000K) incl.
 IP44 • white



5 996595 714239

71432



LED / 24W
 (1450lm, 2400lm;
 3000K, 4000K, 6000K) incl.
 IP44 • black/white



5 996595 714321

71433



LED / 36W
 (2270lm, 3600lm;
 3000K, 4000K, 6000K) incl.
 IP44 • black/white



5 996595 714338

ALENZO



71424

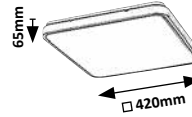

71434

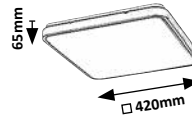

71424



LED / 36W
 (2350lm, 3600lm;
 3000K, 4000K, 6000K) incl.
 406 • IP44 • white



5 996595 714246

71434



LED / 36W
 (2300lm, 3600lm;
 3000K, 4000K, 6000K) incl.
 406 • IP44 • black/white



5 996595 714345



71428, 71430, 71438, 71440



ALENZO



New



71428

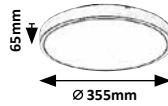

71430

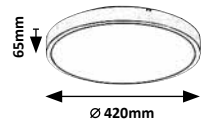

71438

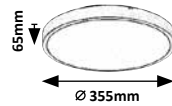

71440

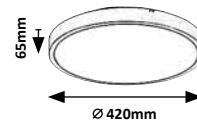

71428

(P)

LED / 24W
 (1530lm, 2400lm;
 3000K, 4000K, 6000K) incl.
 406 • IP44 • white



5 996595 714284

71430

(P)

LED / 36W
 (2450lm, 3600lm;
 3000K, 4000K, 6000K) incl.
 406 • IP44 • white



5 996595 714307

71438

(P)

LED / 24W
 (1500lm, 2400lm;
 3000K, 4000K, 6000K) incl.
 406 • IP44 • black/white



5 996595 714383

71440

(P)

LED / 36W
 (2390lm, 3600lm;
 3000K, 4000K, 6000K) incl.
 406 • IP44 • black/white



5 996595 714406

ALENZO

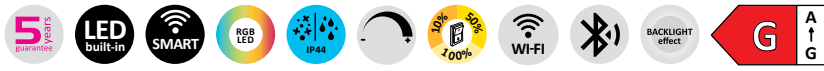

New



7143I

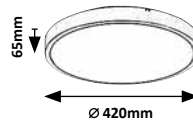

7144I

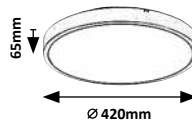

7143I, 7144I



7143I



LED / 36W
 (2450lm, 3600lm;
 3000K, 4000K, 6000K) incl.
 IP44 • white



5 996595 714314

7144I



LED / 36W
 (2380lm, 3600lm;
 3000K, 4000K, 6000K) incl.
 IP44 • black/white



5 996595 714413

SAMIRA



71252

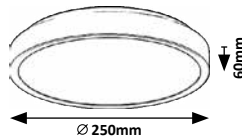

71253

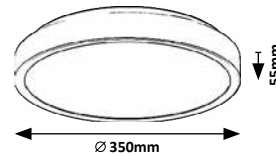

71254

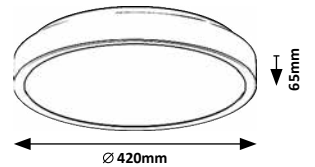

71255

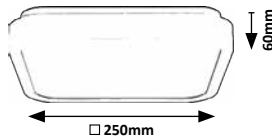

71256

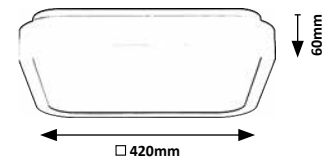

71252



LED / 18W
 (1380lm, 1800lm;
 4000K) incl. • IP44
 black/white



5 996595 712525

71253



LED / 36W
 (2900lm, 3600lm;
 4000K) incl. • IP44
 black/white



5 996595 712532

71254



LED / 48W
 (3100lm, 4800lm;
 4000K) incl. • IP44
 black/white



5 996595 712549

71255



LED / 18W
 (1400lm, 1800lm;
 4000K) incl. • IP44
 black/white



5 996595 712556

71256



LED / 48W
 (3100lm, 4800lm;
 4000K) incl. • IP44
 black/white



5 996595 712563

SAMIRA



71257

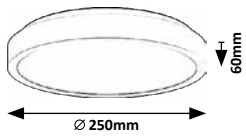

71258

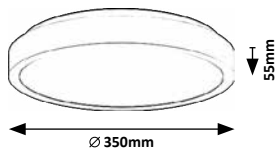

71259

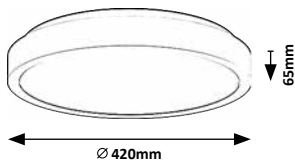

71260

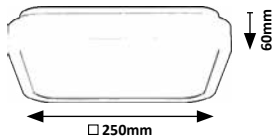

71261

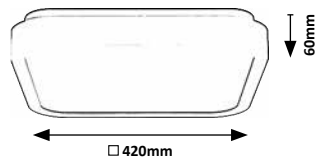

71257



LED / 18W
 (1400lm, 1800lm;
 4000K) incl. • IP44
 white



5 996595 712570

71258



LED / 36W
 (2930lm, 3600lm;
 4000K) incl. • IP44
 white



5 996595 712587

71259



LED / 48W
 (3150lm, 4800lm;
 4000K) incl. • IP44
 white



5 996595 712594

71260



LED / 18W
 (1430lm, 1800lm;
 4000K) incl. • IP44
 white



5 996595 712600

71261



LED / 48W
 (3150lm, 4800lm;
 4000K) incl. • IP44
 white



5 996595 712617



ERIC

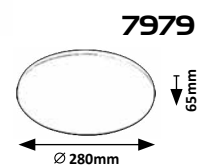

LUCAS

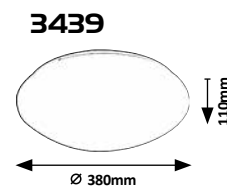
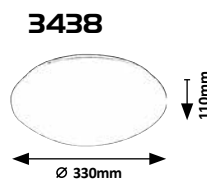
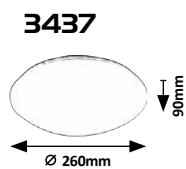

7979 P

LED / 24W
(2160lm, 4000K) incl.
IP64
white



3437 M P

LED / 12W
(900lm, 4000K) incl.
IP44 • 19714
white



3438 M P

LED / 18W
(1350lm, 4000K) incl.
IP44 • 19715
white



3439 M P

LED / 24W
(1800lm, 4000K) incl.
IP44 • 19716
white



GAELO



75025

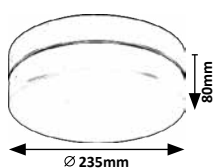

75026

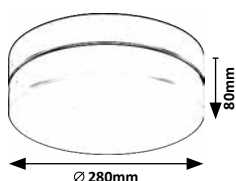

75025, 75026



PERNIK



7250

NATURAL White



7265

WARM White

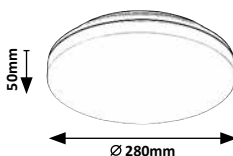

75025 (M P)

LED / 15W
 (11150lm, 1500lm;
 4000K) incl. • IP44 • 20098
 black/white



5 996595 750251

75026 (M P)

LED / 18W
 (1370lm, 1820lm;
 4000K) incl. • IP44 • 20094
 black/white



5 996595 750268

7250 (P)

LED / 24W
 (2400lm, 2565lm; 4000K) incl.
 IP54
 black/white



5 998250 372501

7265 (P)

LED / 24W
 (2400lm, 2565lm; 3000K) incl.
 IP54
 black/white



5 998250 372655



LARCIA



75009

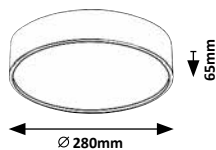

75010

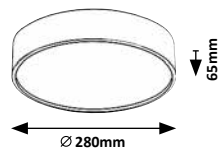

AUSTIN



8797

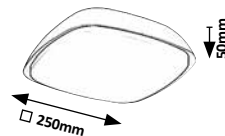

75009



LED / 18W
 (970lm, 1800lm;
 4000K) incl. • IP44 • 19992
 black/white



5 996595 750091

75010



LED / 18W
 (1060lm, 1800lm;
 4000K) incl. • IP44 • 19134
 silver/white



5 996595 750107

8797



LED / 20W
 (2000lm, 4000K) incl.
 IP65
 anthracite/white



5 998250 387970

STUTTGART



8170

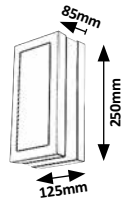

8220

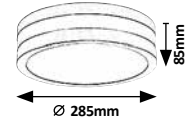

8227

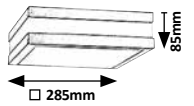

8683

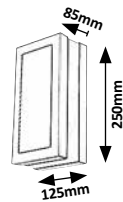

8684

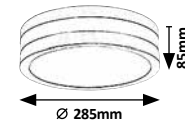

8685

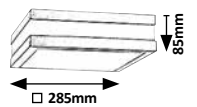

8170 (M) (P)

☒ E27 / 1x max. 14W
IP44
satin chrome/white



5 998250 381701

8220 (M) (P)

☒ E27 / 2x max. 11W
IP44
satin chrome/white



5 998250 382203

8227 (M) (P)

☒ E27 / 2x max. 11W
IP44
satin chrome/white



5 998250 382272

8683 (M) (P)

☒ E27 / 1x max. 14W
IP44
anthracite/white



5 998250 386836

8684 (M) (P)

☒ E27 / 2x max. 11W
IP44
anthracite/white



5 998250 386843

8685 (M) (P)

☒ E27 / 2x max. 11W
IP44
anthracite/white



5 998250 386850

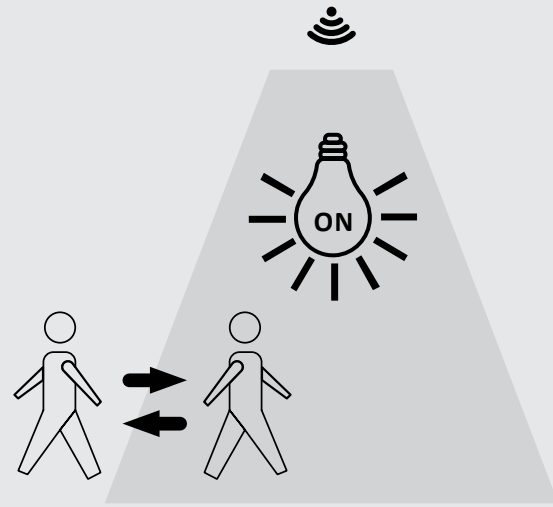
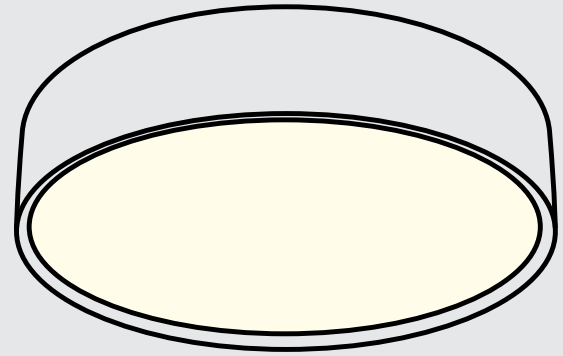
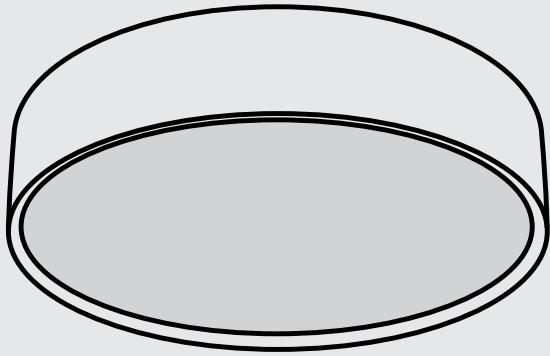

adjustable • állítható • einstellbar

	1	2	Detection Area	3	4	5	Hold Time	6	7	8	Daylight Sensor
I	ON	ON	100%	ON	ON	ON	5s	ON	ON	ON	2Lux
II	ON	-	75%	ON	ON	-	30s	ON	ON	-	10Lux
III	-	ON	50%	ON	-	ON	1min	-	ON	-	25Lux
IV	-	-	25%	ON	-	-	3min	ON	-	-	50Lux
V				-	ON	ON	5min	-	-	-	Disable
VI				-	ON	-	10min				
VII				-	-	ON	20min				
VIII				-	-	-	30min				

LARCIA



75012

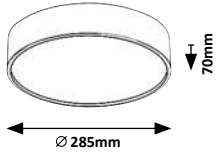

75011

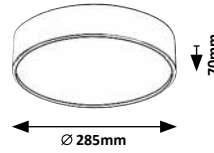

LUCAS



71132



71133

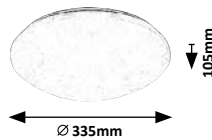

71134

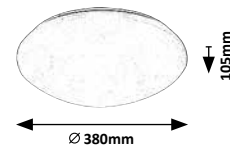

75011 (P)

LED / 19W
 (10000lm, 19000lm;
 4000K) incl. • IP44 • 6m, 120°
 20010 • black/white



5 996595 750114

75012 (P)

LED / 19W
 (10700lm, 19000lm;
 4000K) incl. • IP44 • 6m, 120°
 20011 • white



5 996595 750121

71132 (M P)

LED / 12W
 (8300lm, 12000lm;
 4000K) incl. • IP44 • 6m, 120°
 19714 • white



5 996595 711320

71133 (M P)

LED / 18W
 (11800lm, 18000lm;
 4000K) incl. • IP44 • 6m, 120°
 19715 • white



5 996595 711337

71134 (M P)

LED / 24W
 (17500lm, 24000lm;
 4000K) incl. • IP44 • 6m, 120°
 19716 • white



5 996595 711344



LOWAR



77137

WARM
White

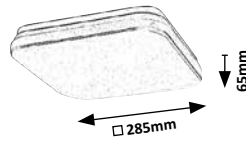

77138

NATURAL
White



77139

WARM
White

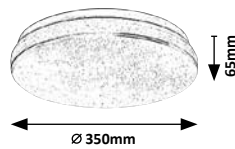

77140

NATURAL
White

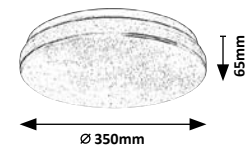

77137

(P)

LED / 18W
(☰) 1150lm; (☲) 1800lm,
3000K incl. • IP44
☰ 5m, 360° • white



5 996595 771379

77138

(P)

LED / 18W
(☰) 1150lm; (☲) 1800lm,
4000K incl. • IP44
☰ 5m, 360° • white



5 996595 771386

77139

(P)

LED / 24W
(☰) 1450lm; (☲) 2400lm,
3000K incl. • IP44
☰ 5m, 360° • white



5 996595 771393

77140

(P)

LED / 24W
(☰) 1450lm; (☲) 2400lm,
4000K incl. • IP44
☰ 5m, 360° • white



5 996595 771409

ZENON

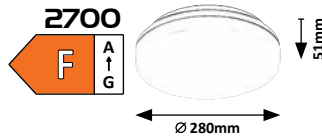
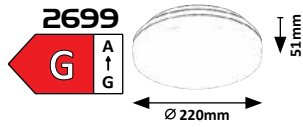

2699, 2700



2699

(P)

LED / 18W
 (E) 1450lm; (E) 1880lm,
 3000K, 4000K, 6000K) incl.
 IP54 • 10m, 360° • white



5 998250 326993

2700

(P)

LED / 24W
 (E) 2100lm; (E) 2565lm,
 3000K, 4000K, 6000K) incl.
 IP54 • 10m, 360° • white



5 998250 327006



HITURA



LENTIL



77028 (P)

LED / 15W
 (1350lm, 1800lm; 4000K) incl.
 IP54 • 6±2m, 120°
 black/white



5 996595 770280

77029 (P)

LED / 15W
 (1500lm, 1800lm; 4000K) incl.
 IP54 • 6±2m, 120°
 white



5 996595 770297

5810 (P)

E27 / 1x max. 60W
 IP54
 white



5 998250 358109

HORT

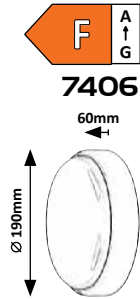

7406

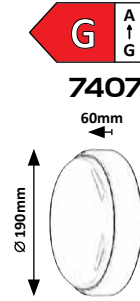

7407

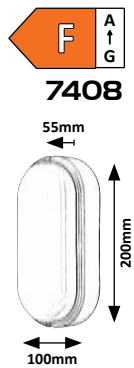

7408

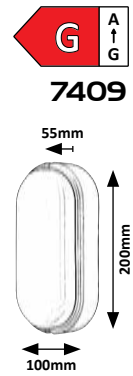

7409



7406



LED / 15W
(1300lm, 1490lm; 4000K) incl.
IP54
white



5 998250 374062

7407



LED / 15W
(1100lm, 1350lm; 4000K) incl.
IP54
black/white



5 998250 374079

7408



LED / 15W
(1300lm, 1490lm; 4000K) incl.
IP54
white



5 998250 374086

7409



LED / 15W
(1100lm, 1350lm; 4000K) incl.
IP54
black/white



5 998250 374093

03

CLASSIC PRODUCT FAMILIES

KLASSZIKUS TERMÉKCSALÁDOK

KLASSISCHE PRODUKTFAMILIEN





NIZZA

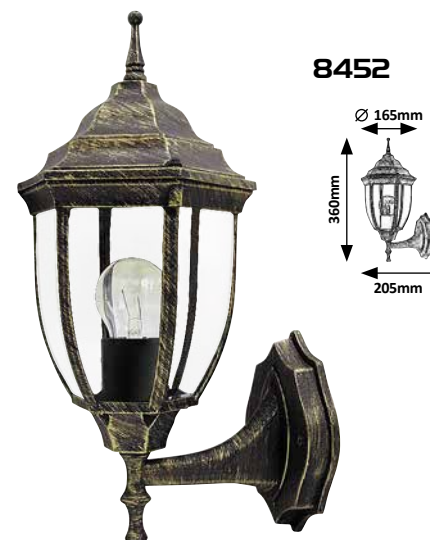

8452

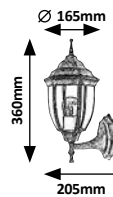

8451

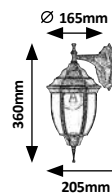

8458

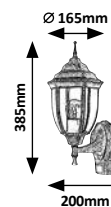

8451 (M) (G)

⊗ E27 / 1x max. 60W
IP43 • 9837
antique gold/transparent



8452 (M) (G)

⊗ E27 / 1x max. 60W
IP43 • 9837
antique gold/transparent



8458 (M) (G)

⊗ E27 / 1x max. 60W
IP43 • 9837
8m, 120°
antique gold/transparent



MONACO

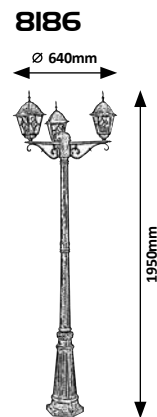
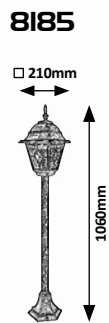
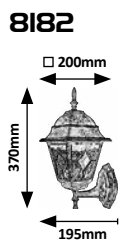
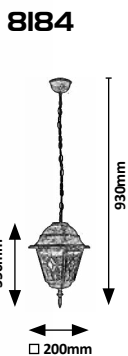
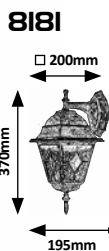

8181 **M G**
 ☒ E27 / 1x max. 60W
 IP43 • 19053
 antique gold/multicolour



5 998250 381817

8182 **M G**
 ☒ E27 / 1x max. 60W
 IP43 • 19053
 antique gold/multicolour



5 998250 381824

8184 **M G**
 ☒ E27 / 1x max. 60W
 IP43 • 19053
 antique gold/multicolour



5 998250 381848

8185 **M G**
 ☒ E27 / 1x max. 60W
 IP43 • 19053
 antique gold/multicolour



5 998250 381855

8186 **M G**
 ☒ E27 / 3x max. 60W
 IP43 • 19053
 antique gold/multicolour



5 998250 381862

TORONTO



8380

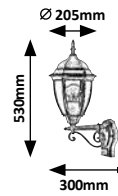

8381

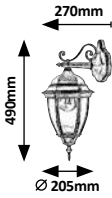

8382

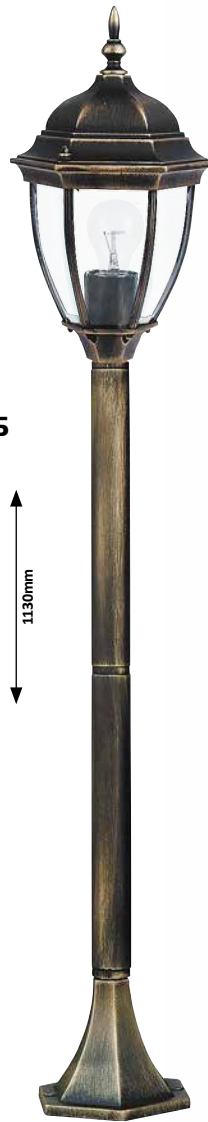
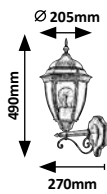

8385

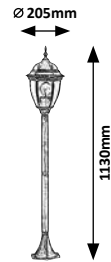

8460

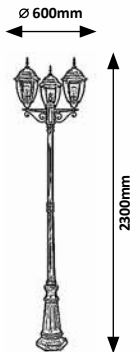

8380 **M G**

☒ E27 / 1x max. 60W
IP44 • 9801
8m, 100°
antique gold/transparent



5 998250 383804

8381 **M G**

☒ E27 / 1x max. 60W
IP44 • 9801
antique gold/transparent



5 998250 383811

8382 **M G**

☒ E27 / 1x max. 60W
IP44 • 9801
antique gold/transparent



5 998250 383828

8385 **M G**

☒ E27 / 1x max. 60W
IP44 • 9801
antique gold/transparent



5 998250 383859

8460 **M G**

☒ E27 / 3x max. 60W
IP44 • 9801
antique gold/transparent



5 998250 384603

TOSCANA

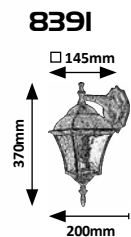

8391

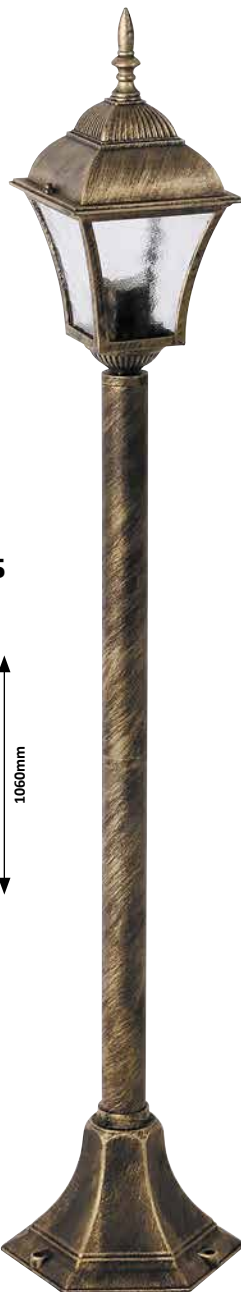

8395

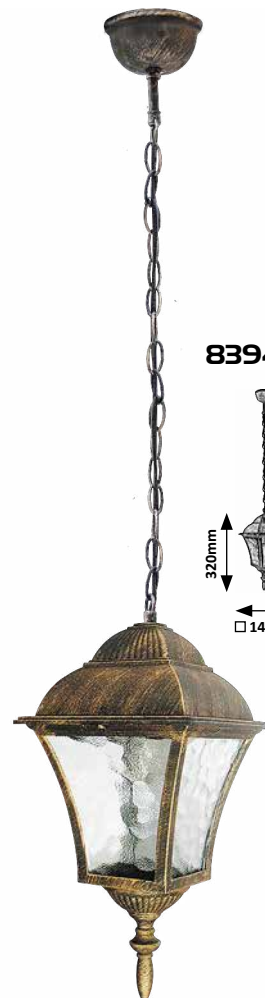
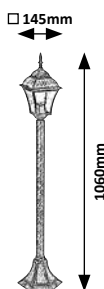

8394

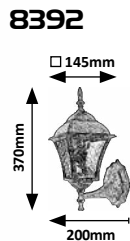
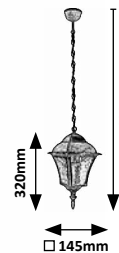

8392

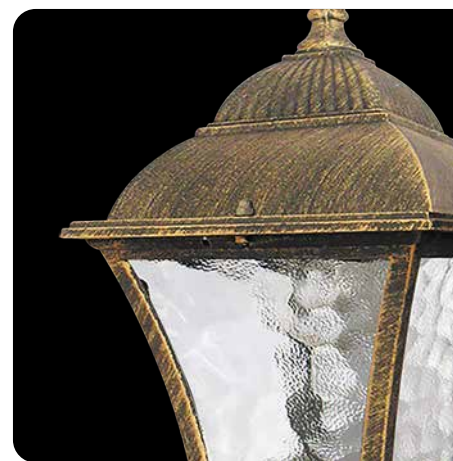

8391 **M G**

☒ E27 / 1x max. 60W
IP43 • 19052
antique gold/transparent



5 998250 383910

8392 **M G**

☒ E27 / 1x max. 60W
IP43 • 19052
antique gold/transparent



5 998250 383927

8394 **M G**

☒ E27 / 1x max. 60W
IP43 • 19052
antique gold/transparent



5 998250 383941

8395 **M G**

☒ E27 / 1x max. 60W
IP43 • 19052
antique gold/transparent



5 998250 383958



8370

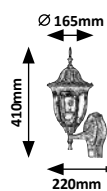

8376

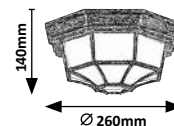

8371



8372

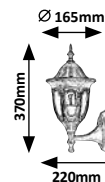

8370 **M G**

☒ E27 / 1x max. 60W
IP43 • 9449
8m, 120°
antique gold/transparent



5 998250 383705

8371 **M G**

☒ E27 / 1x max. 60W
IP43 • 9449
antique gold/transparent



5 998250 383712

8372 **M G**

☒ E27 / 1x max. 60W
IP43 • 9449
antique gold/transparent



5 998250 383729

8376 **M G**

☒ E27 / 1x max. 100W
IP43 • 9446
antique gold/transparent



5 998250 383767

MILANO



8373



8374

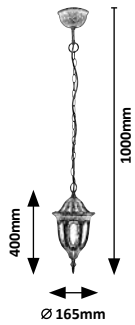

8375

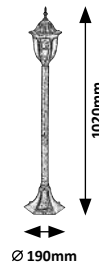

8373 **MG**

☒ E27 / 1x max. 60W
IP43 • 9449
antique gold/transparent



5 998250 383736

8374 **MG**

☒ E27 / 1x max. 60W
IP43 • 9449
antique gold/transparent



5 998250 383743

8375 **MG**

☒ E27 / 1x max. 60W
IP43 • 9449
antique gold/transparent



5 998250 383750

MILANO



7837



8346

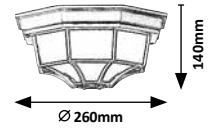

8341



8342



8344

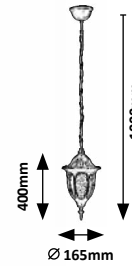

8345

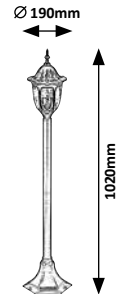

7837 **MG**

⊠ E27 / 1x max. 60W
IP43 • 9449
8m, 120°
black/transparent



5 998250 378374

8341 **MG**

⊠ E27 / 1x max. 60W
IP43 • 9449
black/transparent



5 998250 383415

8342 **MG**

⊠ E27 / 1x max. 60W
IP43 • 9449
black/transparent



5 998250 383422

8344 **MG**

⊠ E27 / 1x max. 60W
IP43 • 9449
black/transparent



5 998250 383446

8345 **MG**

⊠ E27 / 1x max. 60W
IP43 • 9449
black/transparent



5 998250 383453

8346 **MG**

⊠ E27 / 1x max. 100W
IP43 • 9446
black/transparent



5 998250 383460

VELENCE



8202 (M G)

☒ E27 / 1x max. 60W
IP43 • 9283
black/transparent



5 998250 382029

8204 (M G)

☒ E27 / 1x max. 60W
IP43 • 9283
black/transparent



5 998250 382043

8206 (M G)

☒ E27 / 1x max. 60W
IP43 • 9283
black/transparent



5 998250 382067

8208 (M G)

☒ E27 / 1x max. 60W
IP43 • 9283
black/transparent



5 998250 382081

8210 (M G)

☒ E27 / 1x max. 60W
IP43 • 9283
black/transparent



5 998250 382104

8217 (M G)

☒ E27 / 1x max. 60W
IP43 • 9283
8m, 120°
black/transparent



5 998250 382173

VELENCE



8203

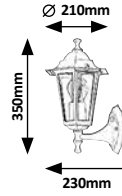

8201

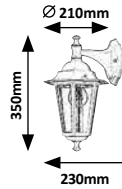

8205

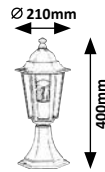

8207

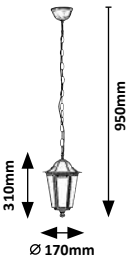

8216

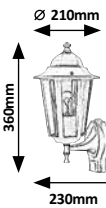

8209

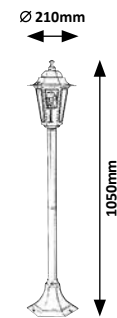

8201 **M G**

☒ E27 / 1x max. 60W
IP43 • 9283
white/transparent



5 998250 382012

8203 **M G**

☒ E27 / 1x max. 60W
IP43 • 9283
white/transparent



5 998250 382036

8205 **M G**

☒ E27 / 1x max. 60W
IP43 • 9283
white/transparent



5 998250 382050

8207 **M G**

☒ E27 / 1x max. 60W
IP43 • 9283
white/transparent



5 998250 382074

8209 **M G**

☒ E27 / 1x max. 60W
IP43 • 9283
white/transparent



5 998250 382098

8216 **M G**

☒ E27 / 1x max. 60W
IP43 • 9283
8m, 120°
white/transparent



5 998250 382166

VELENCE



8218

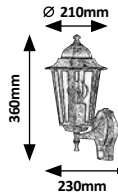

8234

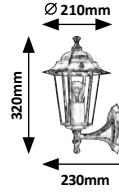

8236

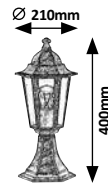

8232

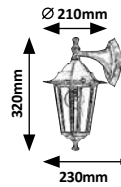

8240

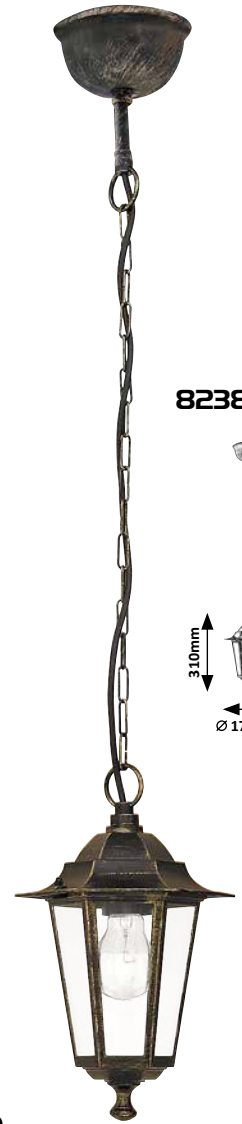
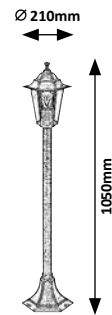

8238

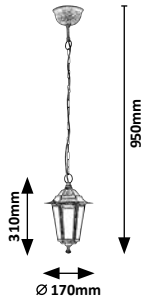

8218

M G

☒ E27 / 1x max. 60W
IP43 • 9283
☒ 8m, 120°
antique gold/transparent



5 998250 382180

8232

M G

☒ E27 / 1x max. 60W
IP43 • 9283
antique gold/transparent



5 998250 382326

8234

M G

☒ E27 / 1x max. 60W
IP43 • 9283
antique gold/transparent



5 998250 382340

8236

M G

☒ E27 / 1x max. 60W
IP43 • 9283
antique gold/transparent



5 998250 382364

8238

M G

☒ E27 / 1x max. 60W
IP43 • 9283
antique gold/transparent



5 998250 382388

8240

M G

☒ E27 / 1x max. 60W
IP43 • 9283
antique gold/transparent



5 998250 382401



ODESSA

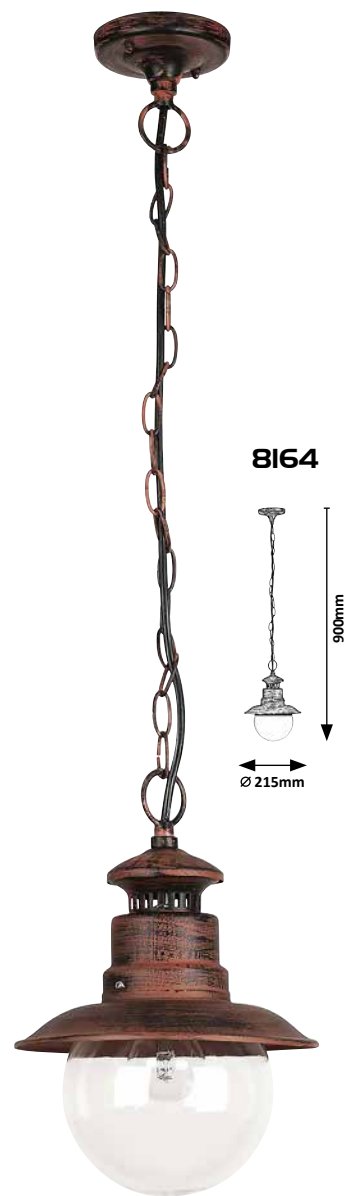

8163 (M) (P)

☒ E27 / 1x max. 60W
IP44 • 19447
antique brown/transparent



8164 (M) (P)

☒ E27 / 1x max. 60W
IP44 • 19447
antique brown/transparent



8165 (M) (P)

☒ E27 / 1x max. 60W
IP44 • 19447
antique brown/transparent



BARCELONA

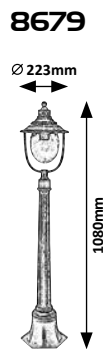
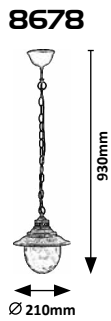
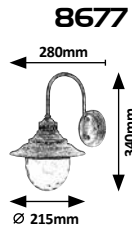

8677 **MG**

☒ E27 / 1x max. 60W
IP43 • 19375
antique gold/transparent



5 998250 386775

8678 **MG**

☒ E27 / 1x max. 60W
IP43 • 19375
antique gold/transparent



5 998250 386782

8679 **MG**

☒ E27 / 1x max. 60W
IP43 • 19375
antique gold/transparent



5 998250 386799



MADRID



8476

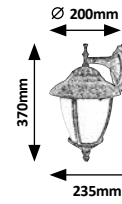

7836

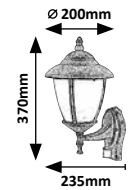

8377

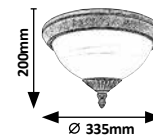

7836 **MG**

☒ E27 / 1x max. 60W
IP43 • 9865
8m, 120°
antique gold/alabaster



8377 **MG**

☒ E27 / 2x max. 40W
IP43 • 9866
antique gold/alabaster



8476 **MG**

☒ E27 / 1x max. 60W
IP43 • 9865
antique gold/alabaster



MADRID

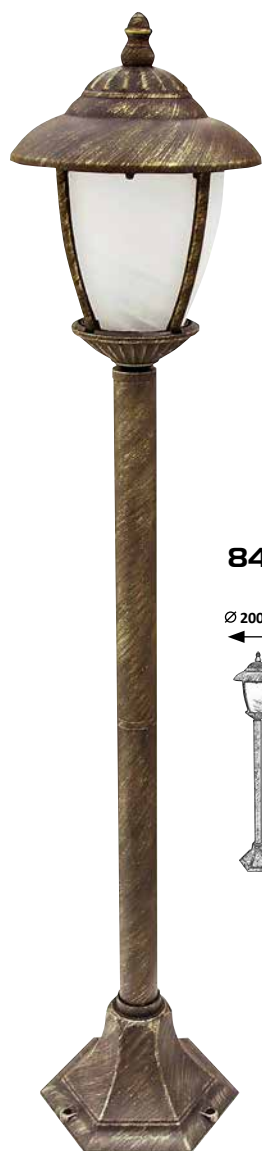

8480

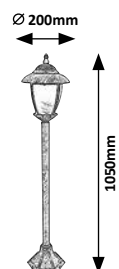

8379

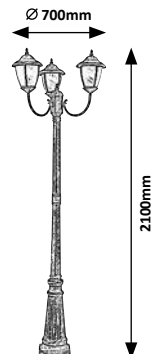

8379 **MG**

☒ E27 / 3x max. 60W
IP43 • 9865
antique gold/alabaster



5 998250 383798

8480 **MG**

☒ E27 / 1x max. 60W
IP43 • 9865
antique gold/alabaster



5 998250 384801





MARSEILLE



8570 (M) (P)

☒ E27 / 1x max. 60W
IP44
black/transparent



8617 (M) (P)

☒ E27 / 1x max. 60W
IP44
black/transparent



8618 (M) (P)

☒ E27 / 1x max. 60W
IP44
black/transparent



MARSEILLE



8568

Ø 170mm

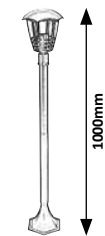

1000mm



8569

Ø 500mm

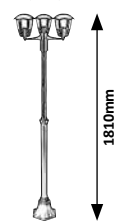

1810mm

8568 (M) (P)

☒ E27 / 1x max. 60W
IP44
black/transparent



5 998250 385686

8569 (M) (P)

☒ E27 / 3x max. 60W
IP44
black/transparent



5 998250 385693





KONSTANZ



8245

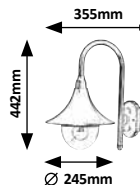

8247

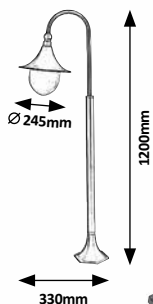

8246

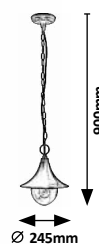

8248

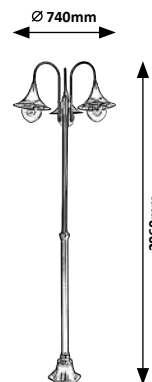

8245 (M) (P)

☒ E27 / 1x max. 100W
IP44 • 19609
black/transparent



5 998250 382456

8246 (M) (P)

☒ E27 / 1x max. 100W
IP44 • 19609
black/transparent



5 998250 382463

8247 (M) (P)

☒ E27 / 1x max. 100W
IP44 • 19609
black/transparent



5 998250 382470

8248 (M) (P)

☒ E27 / 3x max. 100W
IP44 • 19609
black/transparent



5 998250 382487

VIGO

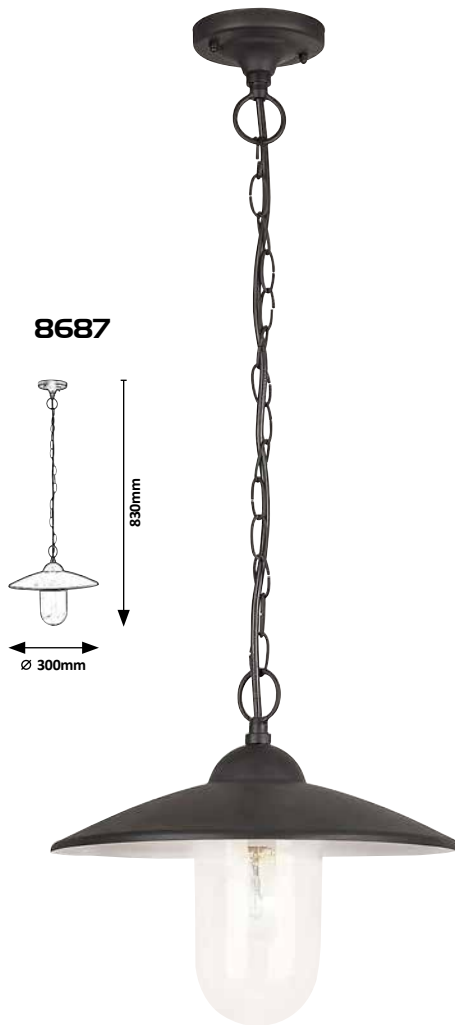

8686 (M) (G)

☒ E27 / 1x max. 60W
IP44 • 19446
matte black/transparent



5 998250 386867

8687 (M) (G)

☒ E27 / 1x max. 60W
IP44 • 19446
matte black/transparent



5 998250 386874



8763



8270



OSLO



8270

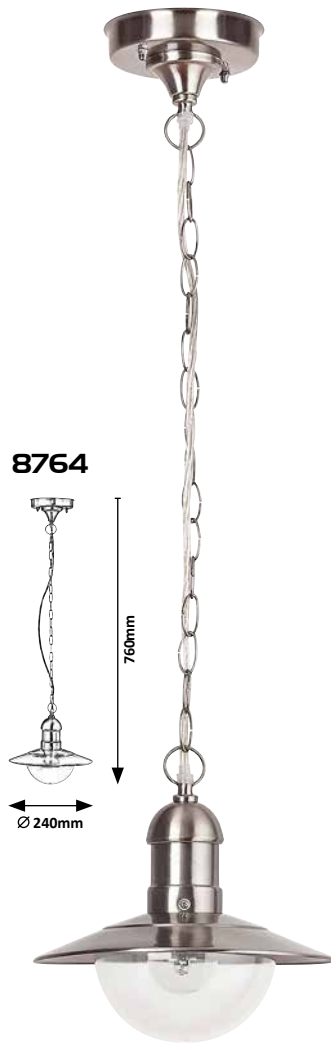
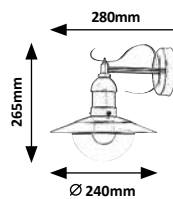

8764



8763

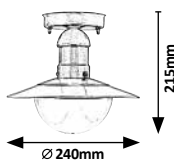

8270 (M) (P)

E27 / 1x max. 60W
IP44 • 19050
satin chrome/transparent



5 998250 382708

8763 (M) (P)

E27 / 1x max. 60W
IP44 • 19050
satin chrome/transparent



5 998250 387635

8764 (M) (P)

E27 / 1x max. 60W
IP44 • 19050
satin chrome/transparent



5 998250 387642

OSLO

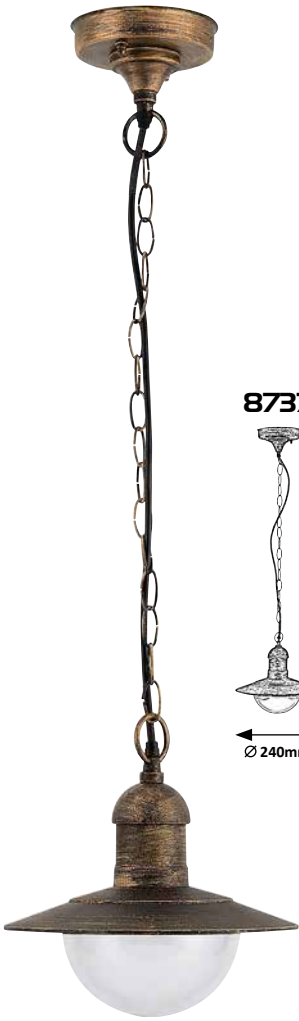

8737



8271

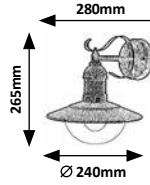

8736

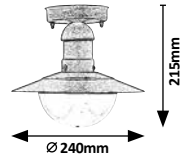

8739

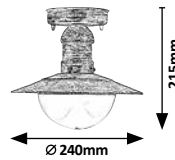

8681

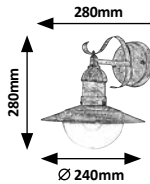

8740

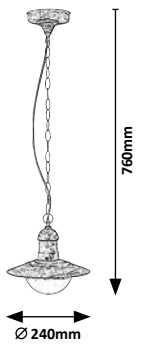

8271

(M P)

☒ E27 / 1x max. 60W
IP44 • 19050
antique gold/transparent



5 998250 382715

8681

(M P)

☒ E27 / 1x max. 60W
IP44 • 19050
antique white/transparent



5 998250 386812

8736

(M P)

☒ E27 / 1x max. 60W
IP44 • 19050
antique gold/transparent



5 998250 387369

8737

(M P)

☒ E27 / 1x max. 60W
IP44 • 19050
antique gold/transparent



5 998250 387376

8739

(M P)

☒ E27 / 1x max. 60W
IP44 • 19050
antique white/transparent



5 998250 387390

8740

(M P)

☒ E27 / 1x max. 60W
IP44 • 19050
antique white/transparent



5 998250 387406

OSLO



8680

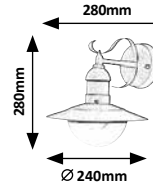

8682

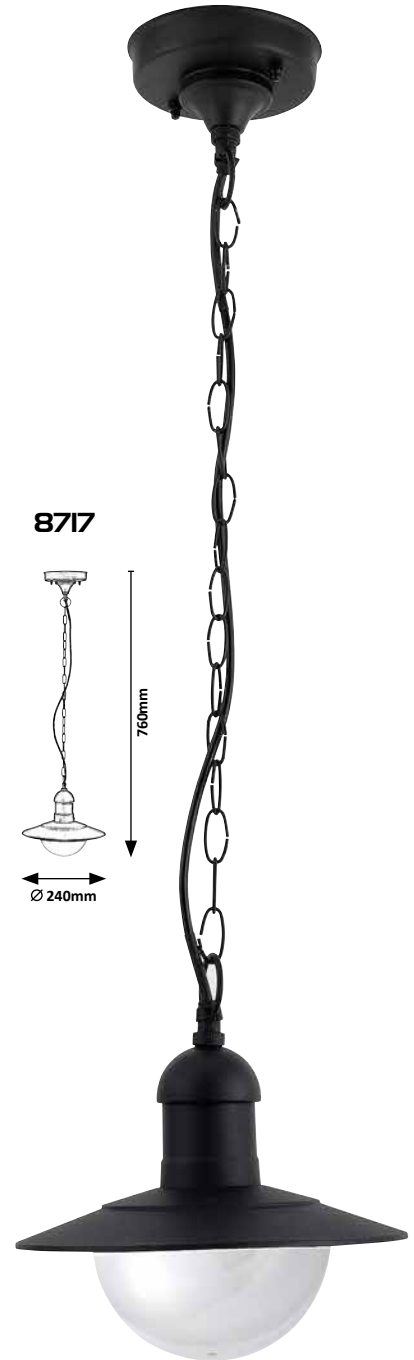
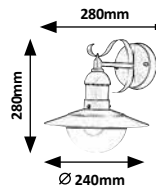

8717

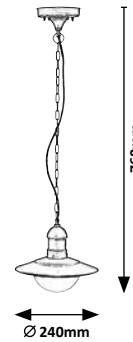

8716

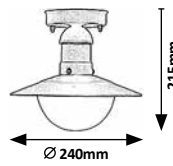

8680 (M) (P)

☒ E27 / 1x max. 60W
IP44 • 19050
black/transparent



5 998250 386805

8682 (M) (P)

☒ E27 / 1x max. 60W
IP44 • 19050
green/transparent



5 998250 386829

8716 (M) (P)

☒ E27 / 1x max. 60W
IP44 • 19050
black/transparent



5 998250 387161

8717 (M) (P)

☒ E27 / 1x max. 60W
IP44 • 19050
black/transparent



5 998250 387178

SYDNEY



8388



HAGA

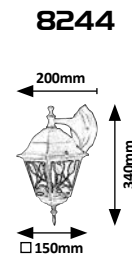
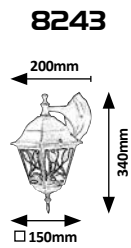

8244



8243 (M) (G)

☒ E27 / 1x max. 100W
IP44 • 19187
black/transparent



8244 (M) (G)

☒ E27 / 1x max. 100W
IP44 • 19187
antique gold/transparent



8387 (M) (G)

☒ E27 / 1x max. 60W
IP23 • 9802
black/transparent



8388 (M) (G)

☒ E27 / 1x max. 60W
IP23 • 9802
antique gold/transparent





DARIUS

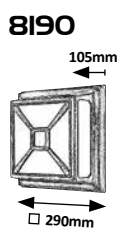

ZATON



7070

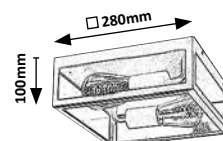

DURANGO

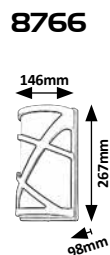

8767

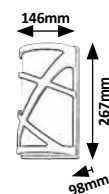

8190 (M) (P)

☒ E27 / 2x max. 60W
IP54
antique gold/white



7070 (M) (G)

☒ E27 / 2x max. 60W
IP23 • 19246
matte black/transparent



8766 (M) (P)

☒ E27 / 1x max. 40W
IP54
brown/white



8767 (M) (P)

☒ E27 / 1x max. 40W
IP54
anthracite/white



HEKTOR

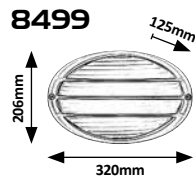
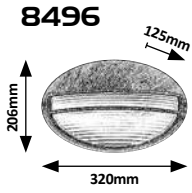

YAGO

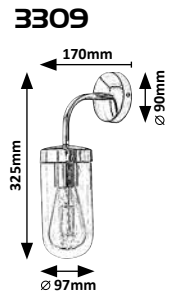

NORVICH

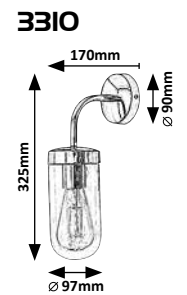
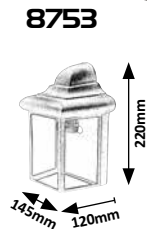

8496 **MG**
 ☒ E27 / 1x max. 100W
 IP54 • ⬆ 9282
 antique gold/transparent



5 998250 384962

8499 **MG**
 ☒ E27 / 1x max. 100W
 IP54 • ⬆ 9282
 antique gold/transparent



5 998250 384993

8753 **MG**
 ☒ E27 / 1x max. 60W
 IP43
 ⬆ 19524 • ⬆ 19523
 antique white/transparent



5 998250 387536

8754 **MG**
 ☒ E27 / 1x max. 60W
 IP43
 ⬆ 19524 • ⬆ 19523
 antique gold/transparent



5 998250 387543

3309 **MG**
 ☒ E27 / 1x max. 60W
 IP44 • ⬆ 19984
 chrome/transparent



5 998250 333090

3310 **MG**
 ☒ E27 / 1x max. 60W
 IP44 • ⬆ 19984
 matte black/transparent



5 998250 333106

04

**TABLE, DECORATIVE,
AND SOLAR LAMPS**

ASZTALI, DEKOR, NAPELEMES LÁMPÁK

TISCH-, DEKOR- UND SOLARLAMPEN



77062



ASSEN



ISHTAR



76013



77062

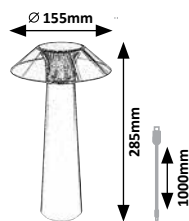

76007

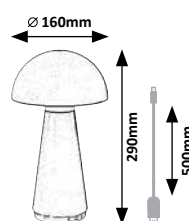

77062 **M P**

LED / 5W (40lm, 150lm; 3000K) incl. • IP44
DC 5V 2200mAh (3,7V DC) incl.
black/tinted colour



5 996595 770624

76007 **P**

LED / 3W (130lm, 300lm; 3000K) incl. • IP44
DC 5V 2000mAh (3,7V DC) incl.
matte black



5 996595 760076

ODERA

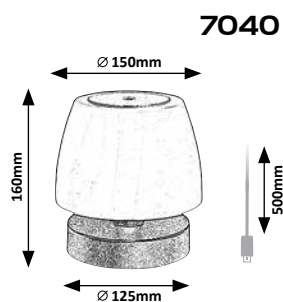
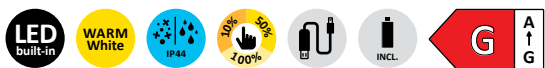

KONIN



TAENA



77089

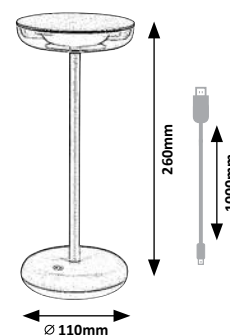

7040

P

LED / 3W
 (140lm, 360lm; 3000K) incl.
 DC 5V 2000mAh (3,7V DC) incl. • IP44
 black/white



5 998250 370408

76010

M P

LED / 4W (200lm, 330lm;
 3000K-5000K) incl.
 DC 3,7V 1800mAh incl. • IP44
 black/white



5 996595 760106

76013

M P

LED / 4W (200lm, 330lm;
 3000K-5000K) incl.
 DC 3,7V 1800mAh incl. • IP44
 silver/white



5 996595 760137

77089

M P

LED / 6W (60lm, 160lm;
 3000K) incl.
 DC 5V 1800mAh (3,7V DC) incl. • IP44
 caramel/transparent



5 996595 770891

77146, 77147



POLPERRO



77146

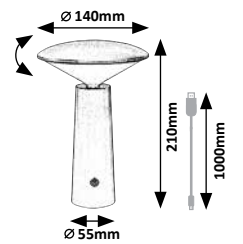

77147

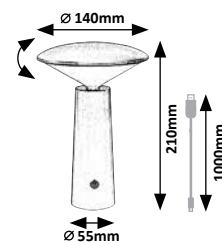

77146



LED / 3W (180lm, 250lm; 2800K, 4000K, 6500K) incl. • IP20 DC 5V 1200mAh (3,7V DC) incl. white



5 996595 771461

77147



LED / 3W (180lm, 250lm; 2800K, 4000K, 6500K) incl. • IP20 DC 5V 1200mAh (3,7V DC) incl. black/white



5 996595 771478

FUNES



77145

BURDUR



77142

77143

(P)

LED / 3W (120lm, 150lm; 2800K, 4000K, 6500K) incl. • IP44 DC 5V 1200mAh (3,7V DC) incl. brown/white



5 996595 771430

77144

(P)

LED / 3W (120lm, 150lm; 2800K, 4000K, 6500K) incl. • IP44 DC 5V 1200mAh (3,7V DC) incl. green/white



5 996595 771447

77145

(P)

LED / 3W (120lm, 150lm; 2800K, 4000K, 6500K) incl. • IP44 DC 5V 1200mAh (3,7V DC) incl. blue/white



5 996595 771454

77142

(P)

LED / 2W (180lm, 270lm; 3000K) incl. • IP44 DC 5V 2000mAh (3,7V DC) incl. black/transparent



5 996595 771423

SAVOCA



77167

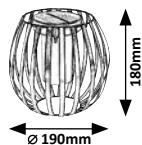

TAPOLCA



77176



SLUIS



77046

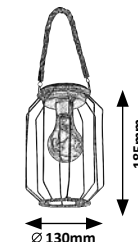

77167 **M P**

LED / 1W
(2)5lm, (3)8lm; 3000K incl.
IP44 • DC 1,2V 300mAh
black/white



77176 **M**

LED / 0,16W
(2)2lm, (3)5lm; 3000K incl.
IP44 • DC 1,2V 400mAh
white



77046 **M P**

LED / 0,2W
(2)3lm, (3)5lm; 3000K incl.
IP44 • DC 1,2V 600mAh
black/transparent



MEDULIN

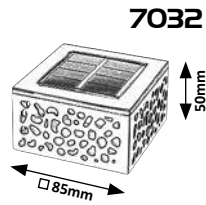

7032

YOLA



7850



LENTULA

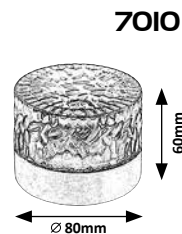

7010



7032 (G) (P)

LED / 0,5W
(8lm, 10lm; 3000K) incl.
DC 1,2V 600mAh incl. • IP44
black



5 998250 370323

7850 (M) (G)

RGB LED / 0,06W
DC 1,2V 60mAh incl.
IP44 • INCL
satin chrome/transparent



5 998250 378503

7010 (M) (P)

LED 0,5W
(10lm, 12lm; 3000K) incl.
DC 1,2V 600mAh incl. • IP44
stainless steel/transparent



5 998250 370101



KROBIA



7814

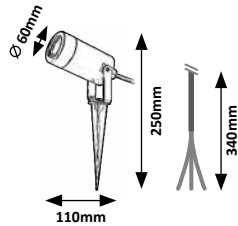

NANTES



77088

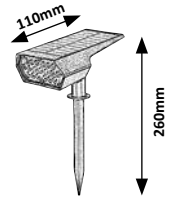

TURDA



7060

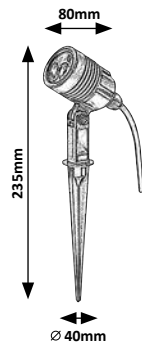

KELNA



77011

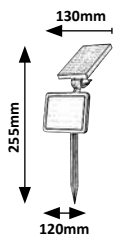

7814 (P)

☒ GU10 / 1x max. 4W
IP65
black/transparent



5 998250 378145

7060 (P)

☒ LED / 3W
(☒260lm, ☒360lm;
4000K) incl. • IP65
black/transparent



5 998250 370606

77088 (P)

☒ LED / 0,5W
(☒50lm, ☒250lm; 3000K) incl.
IP65 • DC 3,7V 3000mAh
black/transparent



5 996595 770884

77011 (P)

☒ LED / 9,6W
(☒200lm, ☒240lm; 4000K) incl.
DC 3,7V 2000mAh incl. • IP44
black/white



5 996595 770112



AMARILLO

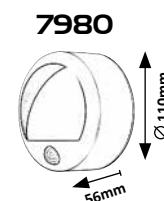
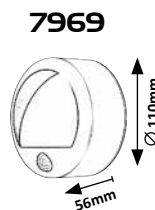

TACOMA

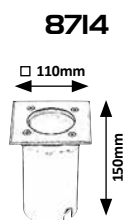

BOVEN

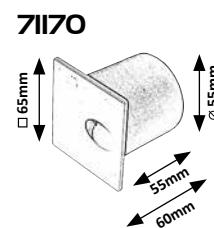
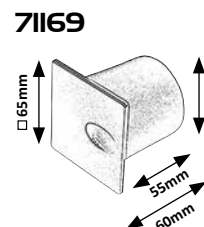
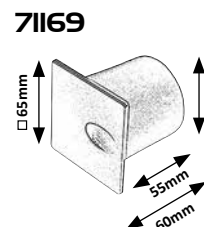

71169, 71170



7969 (P)

LED / 1,5W (50lm, 3000K) incl.
DC 4,5V • 3xAAA excl.
IP44 • 2-8m, 90°
black/white



7980 (P)

LED / 1,5W (50lm, 3000K) incl.
DC 4,5V • 3xAAA excl.
IP44 • 2-8m, 90°
white



8714 (M) (G)

GU10 / 1x max. 50W
IP65
satin chrome



71169 (M)

LED / 3W
(10lm, 60lm; 3000K) incl.
IP54 • 55mm • 55mm
black/transparent



71170 (M)

LED / 3W
(10lm, 60lm; 3000K) incl.
IP54 • 55mm • 55mm
white/transparent



TRENTO



8894



8893



77105

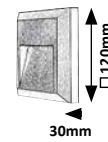

PUEBLO



8011

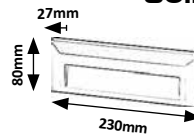

8893

(P)

LED / 3W
(100lm, 4000K) incl.
IP65
white



5 998250 388939

8894

(P)

LED / 3W
(100lm, 4000K) incl.
IP65
anthracite



5 998250 388946

77105

(P)

LED / 4W
(180lm, 400lm;
4000K) incl. • IP65
anthracite/transparent



5 996595 771058

8011

(P)

LED / 1,6W
(103lm, 4000K) incl.
IP65
grey



5 998250 380117

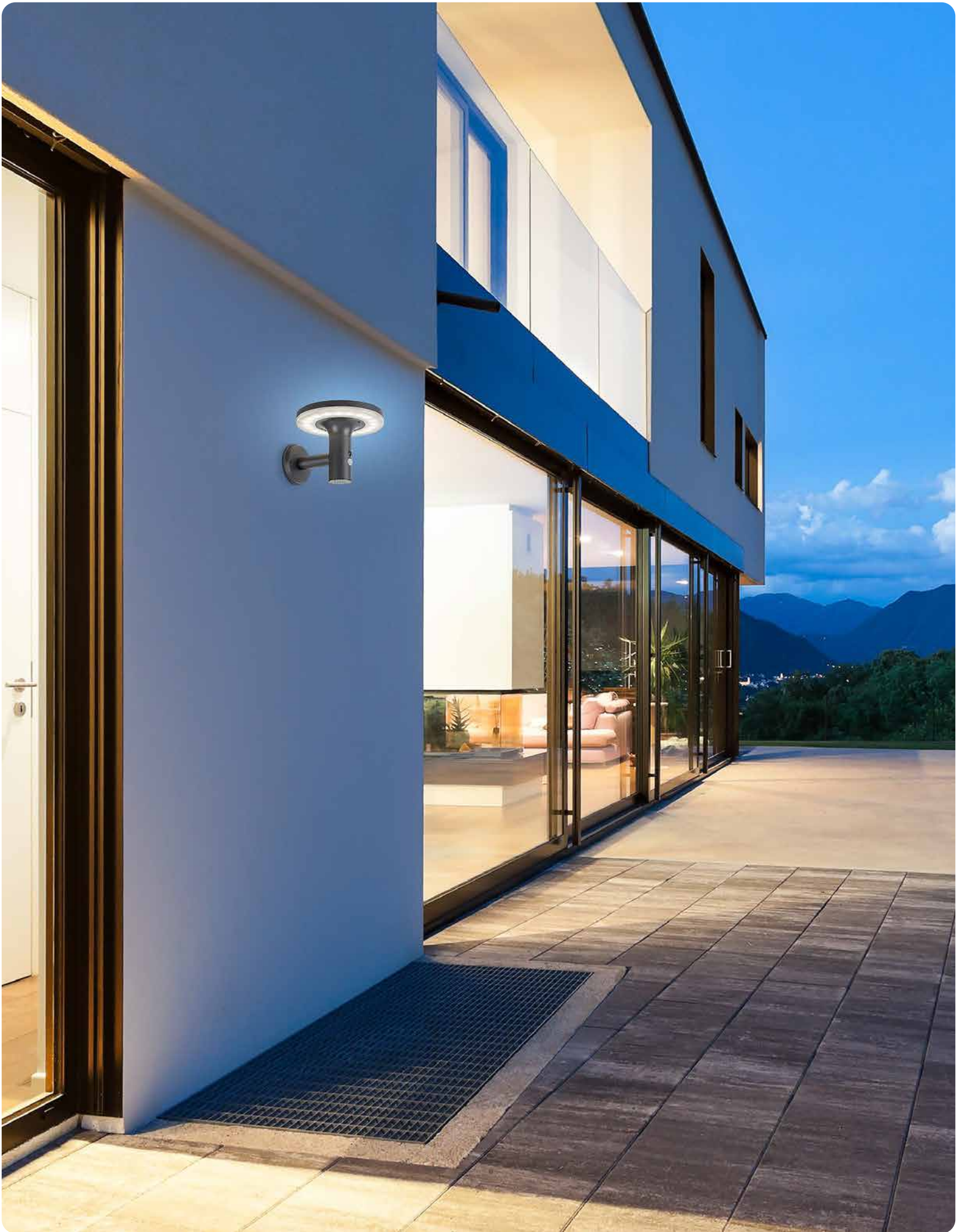

ALASKA



77017

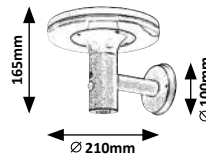

77018

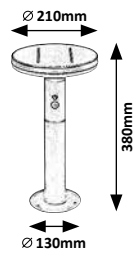

77017 **M P**

LED / 10W (250lm, 300lm; 4000K) incl.
DC 3,7V 2500mAh incl.
IP44 • 5-8m, 120°
anthracite/white



5 996595 770174

77018 **M P**

LED / 10W (250lm, 300lm; 4000K) incl.
DC 3,7V 2500mAh incl.
IP44 • 5-8m, 120°
anthracite/white



5 996595 770181



77044



GELEEN



77044

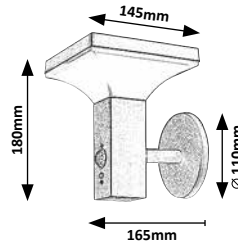

77045

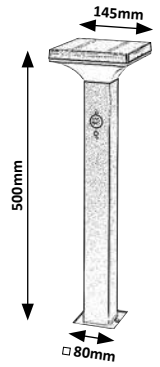

LASSET



77078

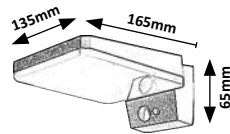

77079

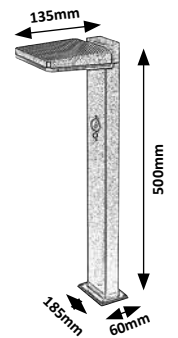

77044 (M) (P)

LED / 4W (400lm, 600lm; 3000K) incl. • IP44 • 6-8m, 110° DC 3,7V 2200mAh black/white



77045 (M) (P)

LED / 4W (400lm, 600lm; 3000K) incl. • IP44 • 6-8m, 110° DC 3,7V 2200mAh black/white



77078 (M) (P)

LED / 4,4W (200lm, 600lm; 4000K) incl. • IP54 • 8m, 110° DC 3,7V 2200mAh black/white



77079 (M) (P)

LED / 4,4W (200lm, 600lm; 4000K) incl. • IP54 • 8-12m, 110° DC 3,7V 2200mAh black/white



ANGERS



77037



LED / 3W (300lm, 450lm; 4000K) incl. • IP54 • 3-5m, 120°
DC 3,7V 2000mAh
grey/transparent



5 996595 770372

77038



LED / 3W
(300lm, 450lm; 4000K) incl.
IP65 • DC 3,7V 2000mAh
grey/transparent



5 996595 770389

77039



LED / 3W
(300lm, 450lm; 4000K) incl.
IP54 • DC 3,7V 2000mAh
grey/transparent



5 996595 770396

77005



MOSELLE

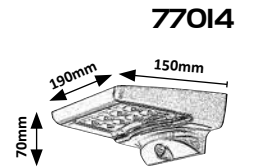

77014

QESA

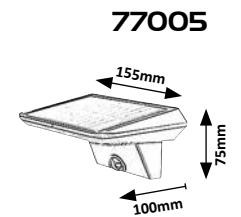

77005

KAPUAS

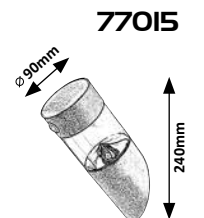

77015

77014 (P)

LED / 4W (300lm, 350lm; 4000K) incl.
DC 3,7V 15000mAh incl.
IP44 • 5-8m, 120°
black/white



5 996595 770143

77005 (P)

LED / 10W (460lm, 800lm; 4000K) incl.
DC 3,7V 1200mAh incl.
IP44 •
black/white



5 996595 770051

77015 (M P)

LED / 1,5W (100lm, 130lm; 4000K) incl.
DC 3,7V 600mAh incl.
IP44 • 5-8m, 120°
black/transparent



5 996595 770150

BREZNO



77006

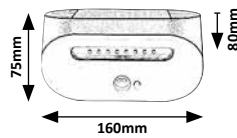

NARMADA



77004

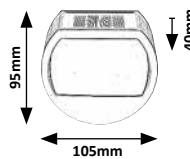

LUTTO



77030

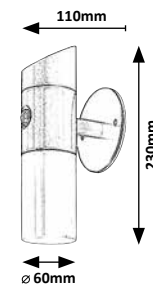

77030



77006



LED / 3,2W (145lm, 200lm; 4000K) incl. • DC 3,7V 1200mAh incl. IP44 • 3-5m, 120° black/white



5 996595 770068

77004



LED / 0,5W (13lm, 20lm; 4000K) incl. DC 1,2V 600mAh incl. • IP44 black/white



5 996595 770044

77030



LED / 1W (65lm, 90lm; 6500K) incl. • IP44 • 10m, 90° DC 3,7V 1200mAh black/white



5 996595 770303



SEPIK



77013

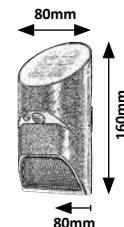

KANGTON



77024

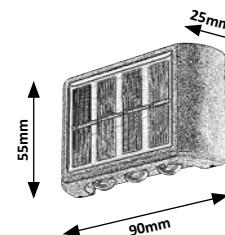

EMMEN



77034

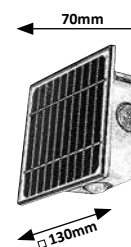

77013

P

LED / 3,6W (150lm, 260lm; 4000K) incl.
DC 3,7V 1800mAh incl.
IP44 • 3-5m, 120°
black/white



77024

P

LED / 1,2W
(8lm, 20lm; 3000K) incl.
DC 1,2V 600mAh incl. • IP44
black



77034

P

LED / 0,5W
(50lm, 60lm; 3000K, 6000K) incl.
IP54 • DC 3,7V 1300mAh
black/transparent



OSTRAVA



7880

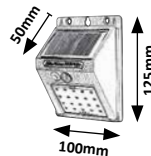

7881

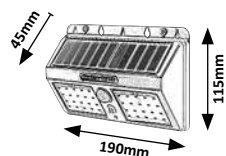

OPAVA



7970

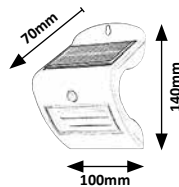

7880



LED / 1,3W (100lm, 4000K) incl.
DC 3,7V incl. • 1x18650 incl.
IP44 • ☔ 0-3m, 120°
black



5 998250 378800

7881



LED / 2,4W (225lm, 4000K) incl.
DC 3,7V incl. • 2x18650 incl.
IP44 • ☔ 0-3m, 120°
black



5 998250 378817

7970



LED / 2W (115lm, 4000K) incl.
DC 3,7V incl. • 1x18650 incl.
IP44 • ☔ 2-8m, 90°
white



5 998250 379708

77040, 77090
Mode A

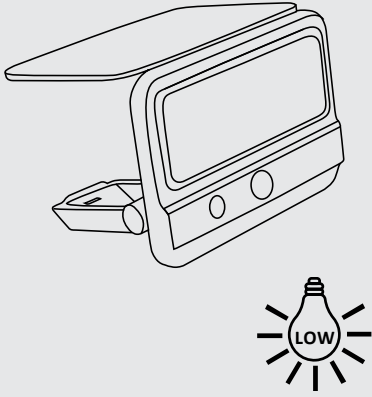

Mode B

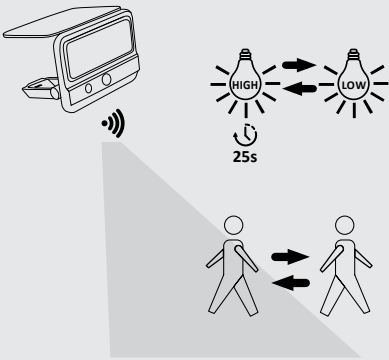

Mode C

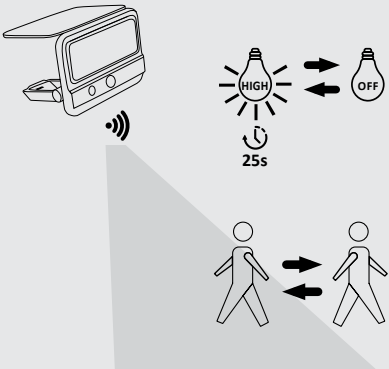

TARCAL

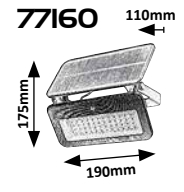

FLAXTON

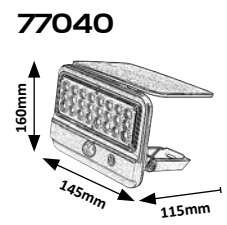
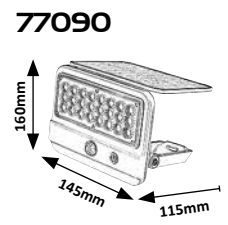

77159 PG

LED / 6W (1000lm, 1300lm; 3000K, 4000K, 6500K) incl. • IP65
3m, 120° • DC 3,7V 2200mAh black/white



77160 PG

LED / 8W (1200lm, 1500lm; 3000K, 4000K, 6500K) incl. • IP65
3m, 120° • DC 3,7V 2600mAh black/white



77040 P

LED / 7W (700lm, 800lm; 4000K) incl. • IP54
3-5m, 120° • DC 3,7V 3000mAh black/transparent



77090 P

LED / 7W (700lm, 800lm; 4000K) incl. • IP54
3-5m, 120° • DC 3,7V 3000mAh white/transparent



LIHULL

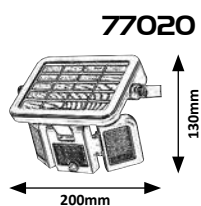

LESZNO

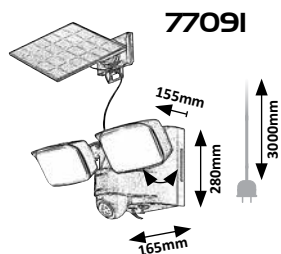

77020

P

LED / 9,6W (500lm, 600lm; 4000K) incl. • IP44 • 5-8m, 120°
DC 3,7V 3000mAh incl.
black/transparent



5 996595 770204

77091

P

LED / 10W (800lm, 1000lm; 4000K) incl. • IP54 • 3-5m, 120°
DC 3,7V 3600mAh
black/white



5 996595 770914



77012



MELK



77141

ZAVOD



77129

77141

P

LED / 6,5W (81000lm, 1050lm;
3000K, 4000K, 6500K) incl. • IP65
568 • DC 5V 1000mAh (3,7V DC) incl.
black/transparent



5 996595 771416

77129

P

LED / 8W (8800lm, 880lm;
5000K) incl. • IP65 • 8m, 120°
579 • DC 3,7V 1800mAh
black/transparent



5 996595 771294

DOJRAN



77021

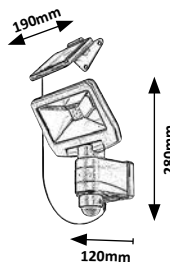

77012



VALPOVO



77019

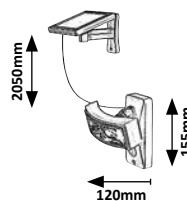

ZLARIN



77012

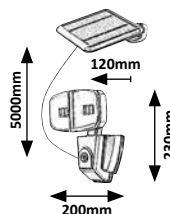

77021

P

LED / 5W (5500lm, 550lm; 4000K) incl.
DC 3,7V 2500mAh incl.
IP44 • 3-10m, 180°
black/transparent



5 996595 770211

77019

P

LED / 2,4W (250lm, 300lm; 4000K) incl.
DC 3,7V 1200mAh incl.
IP44 • 5-8m, 120°
black/transparent



5 996595 770198

77012

P

LED / 12W (700lm, 800lm; 4000K) incl.
DC 3,7V 4000mAh incl.
IP44 • 5-8m, 120°
black/white



5 996595 770129



WIGRY



BOBUS

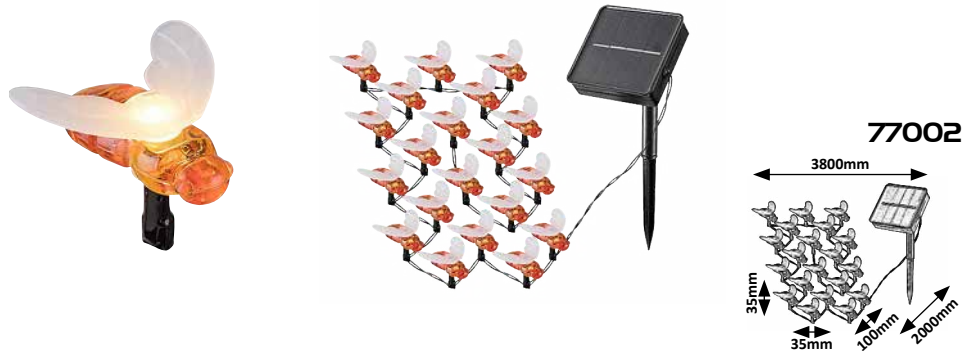

XIMPU



77001 (P)

LED / 0,06W
 (3lm, 8lm; 3000K) incl.
 DC 1,2V 600mAh incl. • IP44
 black/white



77002 (P)

LED / 0,06W
 (3lm, 8lm; 2700K) incl.
 DC 1,2V 600mAh incl. • IP44
 black/white



77003 (P)

LED / 0,1W
 (5lm, 10lm; 2700K) incl.
 DC 1,2V 1200mAh incl. • IP44
 black/white



ZIRC



77165

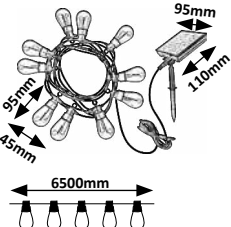

RUPIT

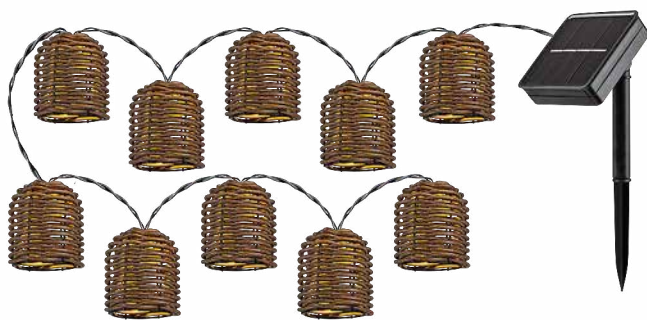

77047

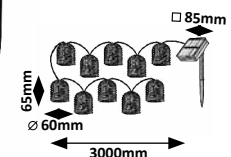

TITU



77048

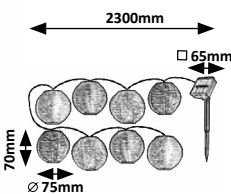

77165

P

LED / 3,6W
 (35lm, 40lm; 2700K) incl.
 IP44 • DC 3,7V 1200mAh
 black/transparent



5 996595 771652

77047

P

LED / 0,6W
 (5lm, 10lm; 3000K) incl.
 IP44 • DC 1,2V 600mAh
 black/natural



5 996595 770471

77048

P

LED / 0,48W
 (4lm, 8lm; 3000K) incl.
 IP44 • DC 1,2V 600mAh
 black/multicolour



5 996595 770488

77158



SKADAR

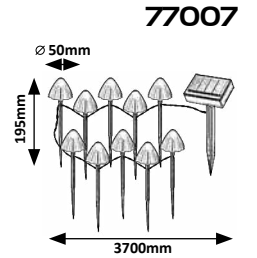

TREPPIO

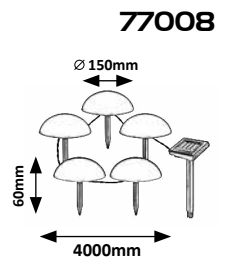

FUNGHETTO

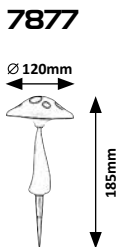

77007 (P)

LED / 2W
 (11lm, 12lm; 2600K) incl.
 DC 1,2V 300mAh incl. • IP44
 black/white



5 996595 770075

77008 (P)

LED / 1W
 (2lm, 6lm; 4000K) incl.
 DC 1,2V 600mAh incl. • IP44
 black/white



5 996595 770082

7877 (P)

LED / 0,06W
 (3000K) incl.
 DC 1,2V 300mAh incl. • 
 IP44 • red/white



5 998250 378770

RAVELLO



77158

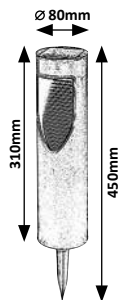

MONOR



77177

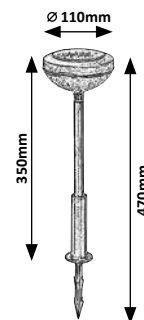

HOLNE



77188

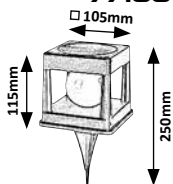

CONG



77186

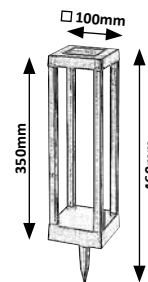

77158



LED / 0,1W
(5lm, 10lm; 3000K) incl.
DC 1,2V 600mAh incl. • IP44
black



5 996595 771584

77177



LED / 0,1W
(3lm, 5lm; 3000K) incl.
DC 1,2V 600mAh incl. • IP44
black/transparent



5 996595 771775

77188



LED / 0,3W
(6lm, 16lm; 2500K-3000K) incl.
DC 3,7V 800mAh incl. • IP44
black/white



5 996595 771881

77186



LED / 0,18W
(6lm, 7lm; 4000K) incl.
DC 3,7V 500mAh incl. • IP44
black



5 996595 771867



MORA



8948

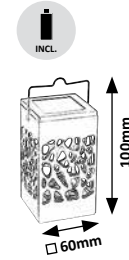

8949

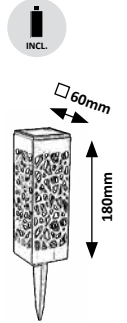

SOLAR 1



8365

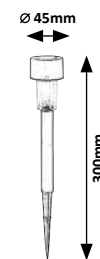

8366

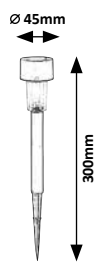

8948 (P)

LED / 0,07W
(1lm, 3000K) incl.
DC 1,2V 200mAh incl. •



8949 (P)

LED / 0,16W
(2lm, 3000K) incl.
DC 1,2V 400mAh incl. •



8365 (P)

LED / 0,1W incl.
DC 1,2V 40mAh incl.
IP44
black



8366 (M P)

LED / 0,1W incl.
DC 1,2V 40mAh incl.
IP44
satin chrome/stainless steel



DANNET



7975

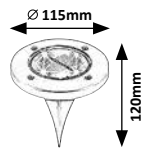

BILBAO



8104

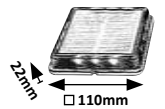

BOKOD



77187

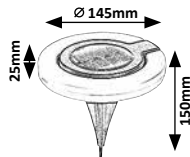

TRILLO



77175



8104

P

LED / 0,2W (4000K) incl.
DC 3,2V 500mAh incl.
IP67
black



5 998250 381046

7975

M P

LED / 0,24W
(20lm, 3000K)
DC 1,2V 400mAh incl. • IP44
satin chrome/ black



5 998250 379753

77187

P

LED / 0,05W
(5lm, 7lm; 2500K-3000K) incl.
DC 1,2V 300mAh incl. • IP44
black/white



5 996595 771874

77175

P

LED / 0,3W
(15lm, 17lm; 4000K) incl.
DC 1,2V 800mAh incl. • IP65
transparent



5 996595 771751

ANSOO



77016

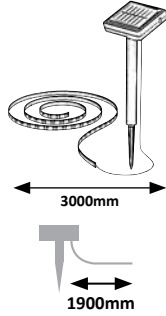

BIRI



New



77123

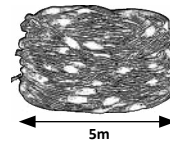

77124

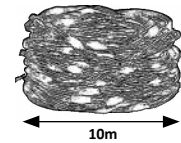

77016



LED / 0,26W
 (30lm, 35lm; 3000K) incl.
 DC 3,2V 400mAh incl. • IP44
 white



5 996595 770167

77123



RGB LED / DC 5V / 2,8W
 IP44
 554
 transparent/white



5 996595 771232

77124



RGB LED / DC 5V / 3,2W
 IP44
 554
 transparent/white



5 996595 771249

LED STRIP



79021



NATURAL White



6,25 cm

192 SMD/m



9,8mm

5000mm

1500mm



79022



10 cm

30 SMD/m



2mm

5000mm

1500mm



79021, 79022



79021



LED / AC 230V / 21W
(2000lm; 4000K) incl.
15.000h • IP67 • 576



5 996595 790219

79022





RGB LED / DC 12V / 19W
CR2025 incl.
25.000h • IP44 • 577











5 996595 790226

LOWAR & ALENZO

PRODUCT RANGE • TERMÉKKÍNÁLATUNK • PRODUKTPALETTE

Article number Cikkszám Artikelnummer	Name Név Name	Size Méret Größe	Lamp color Lámpa szín Lampenfarbe	Color temperature Színhőmérséklet Farbtemperatur		
77133	Lowar	Ø 240mm	white	3000K, 4000K, 6000K	x	
77182	Lowar	Ø 285mm	white	3000K, 4000K, 6000K	x	
77135	Lowar	Ø 410mm	white	3000K, 4000K, 6000K	x	
77134	Lowar	□ 240mm	white	3000K, 4000K, 6000K	x	
77181	Lowar	□ 285mm	white	3000K, 4000K, 6000K	x	
77136	Lowar	□ 410mm	white	3000K, 4000K, 6000K	x	
77139	Lowar	Ø 350mm	white	3000K		x
77140	Lowar	Ø 350mm	white	4000K		x
77137	Lowar	□ 285mm	white	3000K		x
77138	Lowar	□ 285mm	white	4000K		x

Article number Cikkszám Artikelnummer	Name Név Name	Size Méret Größe	Lamp color Lámpa szín Lampenfarbe	Color temperature Színhőmérséklet Farbtemperatur									
71425	Alenzo	Ø 255mm	white	3000K, 4000K, 6000K	x								
71426	Alenzo	Ø 305mm	white	3000K, 4000K, 6000K	x								
71435	Alenzo	Ø 255mm	black	3000K, 4000K, 6000K	x								
71436	Alenzo	Ø 305mm	black	3000K, 4000K, 6000K	x								
71427	Alenzo	Ø 355mm	white	3000K, 4000K, 6000K	x								
71429	Alenzo	Ø 420mm	white	3000K, 4000K, 6000K	x								
71437	Alenzo	Ø 355mm	black	3000K, 4000K, 6000K	x								
71439	Alenzo	Ø 420mm	black	3000K, 4000K, 6000K	x								
71422	Alenzo	□ 290mm	white	3000K, 4000K, 6000K	x								
71423	Alenzo	□ 420mm	white	3000K, 4000K, 6000K	x								
71432	Alenzo	□ 290mm	black	3000K, 4000K, 6000K	x								
71433	Alenzo	□ 420mm	black	3000K, 4000K, 6000K	x								
71424	Alenzo	□ 420mm	white	3000K, 4000K, 6000K		x	x			x		x	
71434	Alenzo	□ 420mm	black	3000K, 4000K, 6000K		x	x			x		x	
71428	Alenzo	Ø 355mm	white	3000K, 4000K, 6000K		x	x			x		x	
71430	Alenzo	Ø 420mm	white	3000K, 4000K, 6000K		x	x			x		x	
71438	Alenzo	Ø 355mm	black	3000K, 4000K, 6000K		x	x			x		x	
71440	Alenzo	Ø 420mm	black	3000K, 4000K, 6000K		x	x			x		x	
71431	Alenzo	Ø 420mm	white	3000K, 4000K, 6000K				x	x		x		x
71441	Alenzo	Ø 420mm	black	3000K, 4000K, 6000K				x	x		x		x

EXTRA FEATURES • EXTRA FUNKCIÓK • EXTRA FUNKTIONEN



Our SMART marked lights can be controlled via the TUYA app available on your smartphone or tablet. The app makes it simple and easy to change the colour temperature and brightness of the lamp, so you can quickly and easily adjust the light to the mood of the occasion during a garden party!



SMART jelöléssel ellátott lámpáink okostelefonon vagy táblagépen elérhető TUYA applikáción keresztül vezérelhetők. Az alkalmazással egyszerűen és könnyedén változtatható a lámpa színhőmérséklete és fényereje, így egy kerti összejövetel közben egyszerűen és gyorsan az adott hangulathoz igazítható a lámpa fénye!



Unsere SMART-gekennzeichneten Leuchten können über die TUYA-App gesteuert werden, die auf Ihrem Smartphone oder Tablet verfügbar ist. Mit der App können Sie ganz einfach die Farbtemperatur und die Helligkeit der Lampe ändern. So können Sie das Licht bei einer Gartenparty schnell und einfach an die Stimmung des Anlasses anpassen!





Colour Temperature: LED lamps offer three options: cool, natural, and warm white. Adjustable colour temperature lamps allow you to adapt the light to your activity or mood. Warm white is ideal for relaxation, while cool white suits tasks requiring focus. CCT lamps let you adjust the colour temperature any time after installation, while DIP SWITCH lamps require selection before installation.



Színhőmérséklet: A LED lámpák három színhőmérsékletet kínálnak: hideg, természetes és meleg fehér. Az állítható színhőmérsékletű lámpák lehetővé teszik a fény hangulathoz vagy tevékenységhez igazítását. A meleg fehér relaxációhoz, a hideg fehér pedig koncentrációt igénylő feladatokhoz ideális. CCT lámpák esetén a színhőmérséklet utólag is állítható, míg DIP SWITCH lámpáknál ezt felszerelés előtt kell beállítani.



Farbtemperatur: LED-Lampen bieten drei Farbtemperaturen: kaltweiß, neutralweiß und warmweiß. Lampen mit einstellbarer Farbtemperatur ermöglichen die Anpassung des Lichts an Stimmung oder Aktivität. Warmweiß eignet sich für Entspannung, kaltweiß für Aufgaben, die Konzentration erfordern. Bei CCT-Lampen kann die Farbtemperatur nach der Installation angepasst werden, während sie bei DIP SWITCH-Lampen vor der Montage eingestellt werden muss.



RGB: RGB (Red-Green-Blue) lighting means that the lamp contains red, green, and blue chips, creating colourful mood lighting. This feature offers creative and unique lighting options and is perfect for creating special light shows.



RGB: Az RGB (Red-Green-Blue) világítás alatt azt értjük, hogy az adott lámpa vörös, zöld és kék chipeket tartalmaz, melyek színes hangulatvilágítást eredményeznek. Ez a funkció kreatív és egyedi megvilágítási lehetőségeket kínál, és alkalmas lehet különleges fényjátékok létrehozására.



RGB: RGB (Rot-Grün-Blau) Beleuchtung bedeutet, dass die Lampe rote, grüne und blaue Chips enthält, die eine farbenfrohe Stimmungsbeleuchtung erzeugen. Diese Funktion bietet kreative und einzigartige Beleuchtungsmöglichkeiten und eignet sich perfekt für spezielle Lichtspiele.



Dimming: Dimming refers to the ability to adjust the lamp's brightness. This can be done in a gradual or continuous manner, using various methods such as switches, touch controls, remote controls, or even apps.



Fényerő-szabályozás: A dimmelhetőség a lámpa fényerősségének változtatását jelenti. Ennek módja lehet fokozatos vagy folyamatos, valamint különböző módon történhet: kapcsolóval, érintéssel, távirányítóval, vagy akár applikációval



Dimmbarkeit: Dimmbarkeit bezeichnet die Möglichkeit, die Helligkeit der Lampe anzupassen. Dies kann stufenweise oder kontinuierlich erfolgen, und zwar auf unterschiedliche Weise: mit Schaltern, Berührung, Fernbedienung oder sogar per App.





INFORMATION BLOCK • INFORMÁCIÓS BLOKK • INFORMATIONSBLOCK

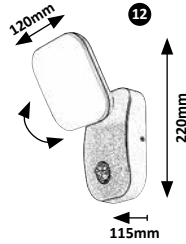

- 1** 9999
- 2** M T
- 3** LED / 50W (3080lm, 3000K-6000K) incl.
- 4** E27 / 1x max. 60W
- 5** IP20 • **6** 19500 • **7** 523
- 8** • DC 1,2V • 1xAA incl.
- 10** white
- 11**
-
- 5 998250 362502

- 1**
- Item No.
 - cikkszám
 - Artikelnummer
 - no. article
 - objednávaci číslo
 - Číslo položky
 - nr artykułu
 - номер виробу
 - nr. Articol
 - Br. Artikla
 - broj artikla
 - številka artikla / artikel št.
 - № на артикул
 - elemento Nr.
 - izstrādājuma Nr.
 - toote Nr.

- 2**
- material of the product
 - a termék anyaga
 - Material des Produkts
 - matériau du produit
 - materiál výrobku
 - Material produktu
 - материал виробу
 - materialul produsului
 - materijal proizvoda
 - material izdelka
 - материал на продукта
 - produkto medžiaga
 - produkta materiāls
 - toote materjal

- 3**
- technical data of lightsource for lamp
 - a lámpához adott fényforrás műszaki adatai
 - Technische Daten des Leuchtmittels zur Leuchte
 - caractéristiques techniques de l'ampoule du luminaire
 - technické údaje svetelného zdroje dodávaného s lampou
 - technické údaje zdroja svetla priloženého k lampe
 - dane techniczne źródła światła dostarczonego z lampą
 - технічні дані джерела освітлення для даної лампи
 - datele tehnice ale sursei de lumină pentru lampă
 - tehnički podaci o izvoru svetlosti za lampu
 - tehnički podaci izvora svjetlosti koji je priložen uz lampu
 - tehnični podatki vira svetlobe za svetilko
 - технически данни на източника на светлина, приложен към лампата
 - švietuvos šviesos šaltinio techniniai duomenys
 - lampas gaismas avota tehniskie dati
 - lambi valgusalikka tehnilised andmed

- 4**
- the specifications of the lightsource
 - a fényforrásra vonatkozó műszaki adatok
 - Angaben zur Lichtquelle
 - les spécifications de la source lumineuse
 - specifikace světelného zdroje
 - specificăcție surselii de iluminat
 - Специфікація джерела світла
 - технічні характеристики джерела освітлення
 - specificatii sursă de iluminat
 - specifikacije svetlosnog izvora
 - specifikacija izvora svjetlosti
 - specifikacije svetlobnega vira
 - характеристики на светлинния източник
 - šviesos šaltinio specifikacijos
 - gaismas avota specifikācijas
 - valgusalikka tehnilised andmed

- 5**
- IP protection
 - IP védettség
 - IP-Klasse
 - protection IP
 - IP kryti
 - IP ochrana
 - Stopień ochrony IP
 - Клас IP-защиты
 - Protecția IP
 - IP zaštita
 - IP zaštita
 - IP zaštita
 - с IP защита
 - IP klasė
 - IP aizsardzība
 - IP kaitse

- 6**
- article number of the replacement lampshade
 - pótbúra cikkszám
 - Artikelnummer des Ersatz-Lampenschirms
 - numéro d'article de l'abat-jour de remplacement
 - číslo výrobku náhradního stínítka
 - číslo výrobku náhradného tienidla
 - Numer artykułu wymiennego klosza
 - номер виробу запасного абажуру
 - număr de articol pentru abajurul înlocuitor
 - Br. artikla rezervnog abažura
 - broj artikla zamjenskog sjenila
 - številka izdelka nadomestnega senčila
 - № на артикул на допълнителен абажур
 - pakaitinio lempos gaubto prekės numeris
 - rezerves abažūra precēs numurs
 - asenduslambivarju artiklinumber

- 7**
- item number remote controller
 - a távirányító cikkszám
 - Artikelnummer der Fernbedienung
 - numéro d'article de la télécommande
 - Číslo položky dálkového ovládače
 - Číslo položky diaľkového ovládača
 - Numer produktu pilota
 - Номер елемента дистанційного керування
 - Număr articol pe telecomandă
 - Broj stavke daljinskog upravljača
 - Broj stavke daljinskog upravljača
 - Številka izdelka daljinskega upravljalnika
 - Каталоген номер на дистанционното управление
 - Nuotolinio valdymo pulto prekės numeris
 - Tālvadības pults vienuma numurs
 - Puldi artiklinumber

- 8**
- type of switch
 - a kapcsoló típusa
 - Typ des Schalters
 - type d'interrupteur
 - druh vypínače
 - druh vypinaca
 - Тип переключника
 - тип перемикача
 - tip de comutator
 - tip prekidača
 - vrsta prekidača
 - vrsta stikala
 - тип на ключа
 - jungiklio tipas
 - sledža tips
 - lüliti tüüp











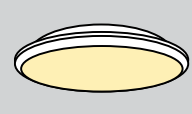
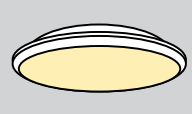

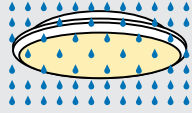
- 9**
- battery specification
 - elemmel kapcsolatos információk
 - Batteriespezifikation
 - spécifications de la pile
 - specifikace baterie
 - specificăcție baterie
 - Специфікація батареї
 - специфікація акумулятора
 - specificatii baterie
 - specifikacija baterije
 - specifikacija baterije
 - specifikacija baterij
 - характеристики на батерията
 - baterijos specifikacijos
 - baterijas specifikācija
 - patareli tehnilised andmed

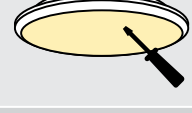
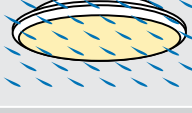
- 10**
- colour of the product
 - a termék színe
 - Farbe des Produkts
 - couleur du produit
 - barva produktu
 - farba produktu
 - Kolor produktu
 - колір виробу
 - culoarea produsului
 - boja proizvoda
 - boja proizvoda
 - barva izdelka
 - цвят на продукта
 - produkto spalva
 - produkta krāsa
 - toote värv

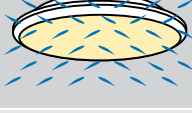
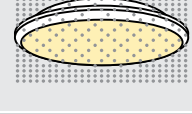
- 11**
- EAN code
 - EAN- kód
 - EAN-Code
 - code EAN
 - EAN- kód
 - EAN- kód
 - kod EAN
 - код EAN
 - cod EAN
 - EAN kód
 - EAN- kod
 - EAN koda
 - EAN kod
 - EAN kodus
 - EAN kods
 - EAN-kood

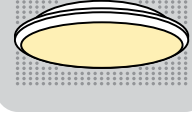
- 12**
- sizes
 - méretek
 - Maß
 - dimensions
 - rozmery
 - rozmiery
 - wymiary
 - розміри
 - dimenzije
 - dimenzije
 - mere
 - razméri
 - išmatavimai
 - izmēri
 - suurus

IP RATING • IP VÉDELEM • IP-SCHUTZ

Level of protection • Védelem szintje • Schutzgrad		Level of protection • Védelem szintje • Schutzgrad	
SOLIDS • SZILÁRD TÁRGYAK • FREMDKÖRPER		WATER • VÍZ • WASSER	
	0 EN: No protection. HU: Nincs védelem. DE: Nicht geschützt.		0 EN: No protection. HU: Nincs védelem. DE: Nicht geschützt.
	1 EN: Protected against a solid object greater than 50mm, e.g. a hand. HU: 50 mm vagy nagyobb átmérőjű szilárd tárgyak (pl. kézfej) ellen védett. DE: Geschützt gegen feste Fremdkörper größer als 50 mm (z. B. Handrücken)		1 EN: Protected against vertical water drops. HU: Függőleges irányból leeső vízcseppek ellen védett. DE: Geschützt gegen senkrecht fallendes Tropfwasser
	2 EN: Protected against a solid object greater than 12.5mm, e.g. a finger. HU: 12,5 mm vagy annál nagyobb átmérőjű szilárd tárgyak (pl. ujj) ellen védett. DE: Geschützt gegen feste Fremdkörper größer als 12,5 mm (z. B. Finger)		2 EN: Protected against a 15° angle from normal position. HU: Függőleges irányból leeső vízcseppek ellen védett, a lámpa 15 fokos dőlése mellett. DE: Geschützt gegen Tropfwasser bis 15° zur Senkrechten
	3 EN: Protected against a solid object greater than 2.5mm, e.g. a tool. HU: 2,5 mm vagy annál nagyobb átmérőjű szilárd tárgyak (pl. hegyes szerszám) ellen védett. DE: Geschützt gegen feste Fremdkörper größer als 2,5 mm (z. B. spitze Werkzeuge)		3 EN: Protected against water spray at a 60° angle. HU: Vízpermettől védett legfeljebb 60 fokos szög esetén. DE: Geschützt gegen Sprühwasser bis 60° zur Senkrechten
	4 EN: Protected against a solid object greater than 1.0mm, e.g. a wire. HU: 1 mm vagy annál nagyobb átmérőjű szilárd tárgyak (pl. drót) ellen védett. DE: Geschützt gegen feste Fremdkörper größer als 1 mm (z. B. Draht)		4 EN: Protected against water splashing from any angle. HU: Bármely irányból fröccsenő víz ellen védett. DE: Geschützt gegen Spritzwasser aus allen Richtungen
	5 EN: Dust protected. Prevents ingress of dust sufficient to cause damage. HU: Porvédett. Megakadályozza a károsodás okozásához elegendő mennyiségű por behatolását. DE: Staubgeschützt. Geschützt gegen schädliche Staubbablagerungen		5 EN: Protected against water jets from any angle. HU: Vízugarak ellen védett minden irányból. DE: Geschützt gegen Strahlwasser aus allen Richtungen
	6 EN: Dust tight. No ingress of dust. HU: Porálló. A burkolat nem engedi át a port. DE: Staubdicht. Vollständig geschützt gegen Berührung und Eindringen von Staub		6 EN: Protected against powerful water jets and heavy seas. HU: Erős vízugar ellen védett. DE: Geschützt gegen starkes Strahlwasser
<h1 style="font-size: 48px; margin: 0;">IP 65</h1>			7 EN: Water tight against the effect of temporary immersion in water of a depth between 15cm to 1m for up to 30 minutes. HU: Vízbe merítés ellen védett, ha a lámpát ideiglenesen, legfeljebb 30 perc 15 cm és 1 m közötti mélységű vízbe merítik. DE: Geschützt beim Eintauchen bis zu 30 Minuten bei einer Wassertiefe von 15 cm bis zu 1 m
			8 EN: Water tight against long periods of immersion in water (up to 4m). HU: Folyamatos vízbe merítés káros hatásaitól védett (4 m mélységig). DE: Geschützt beim Untertauchen für längere Periode (bis zu 4 m)

IK CODE • IK-KÓD • IK-CODE

Degree of protection against external mechanical impacts (W), in Joule:

Külső mechanikai igénybevételekkel szembeni védettség(W), Joule-ban • Schutz gegen äußere mechanische Kräfteinwirkungen (W), in Joule:

IK-Code	IK01	IK02	IK03	IK04	IK05	IK06	IK07	IK08	IK09	IK10
W (J)	0.14	0.2	0.35	0.5	0.7	1	2	5	10	20

COLOURS • SZÍNEK • FARBEN



alabaster	alabástrom	Alabasterglas	verre albâtre	alabastrové sklo	alabastrové sklo	szkło alabastrowe	алебастрове скло
anthracite	antracit	Anthrazit	anthracite	antracitová	antracit	antracyt	антрацитовий
antique brown	antik barna	Antikbraun	brun antique	antická hnědá	antická hnedá	brąz antyczny	антично коричневий
antique gold	antik arany	Antikgold	or antique	antická zlatá	antická zlatá	złoto antyczne	антично золотий
antique white	antik fehér	Antik Weiß	blanc antique	antikovaná bílá	antická biela	biały antyk	античний білий
black	fekete	Schwarz	noir	černá	čierna	czarny	чорний
blue	kék	Blau	bleu	modrá	modrá	niebieski	синій
brown	barna	Braun	brun	Hnědá	hnedá	Brązowy	коричневий
brushed aluminium	súrolt alumínium	gebürstetes Aluminium	aluminium brossé	broušený hliník	kartáčovaný hliník	szcztokowane aluminium	полірований алюміній
caramel	karamell	karamellfarbe	couleur caramel	karamelová barva	karamelová farba	kolor karmelowy	карамельний колір
chrome	króm	Chrome	chrome	chromová	chrómová	chrom	хромовий
green	zöld	Grün	vert	zelená	zelená	zielony	зелений
grey	szürke	Grau	gris	šedá	šedá	popielaty	сірий
matte black	matt fekete	Mattschwarz	noir mat	matná černá	matná čierna	czarny matowy	матово-чорний
matte white	matt fehér	Mattweiss	blanc mat	matná bílá	matná biela	biały matowy	матово-білий
multicolour	többszínű	Multicolor	multicolore	vícebarevná	viacfarebná	wielokolorowy	багатокольоровий
oak	tölgy	Eiche	chêne	dub	dub	dąb	дуб
opal glass	opál üveg	Opalglas	verre opal	opálové sklo	opálové sklo	szkło opalizowane	скло опал
red	piros	Rot	rouge	červená	červená	czerwony	червоний
satin chrome	szatin króm	Satin-Chromfarbig	chrome satiné	hedvábně lesklá chro- mová	saténová chrómová	chrom satyna	сатиново хромовий
silver	ezüst	Silber	argent	stříbrná	strieborná	srebrny	срібний
tinted colour	füst színű	Rauchfarbig	fumée	dýmová barva	dymová	przydymiony	димчастий
transparent	átlátszó	transparent	transparent	průhledná	priehľadná	przezroczysty	прозорий
white	fehér	Weiss	blanc	bílá	biela	biały	білий

COLOURS • SZÍNEK • FARBEN



sticlă alabastru	alabastar staklo	alabastar staklo	alabastrno steklo	алабастрово стъкло	rīsu akmens stikls	rīsu akmens stikls	riisikivi klaas
antracit	antracit	antracit	antracitna	антрацитен	antracito pilka	antracīta pelēks	hall antratsiit
maro antic	staro smeđa	staro smeđe	starano rjav	антично кафяв	antikos ruda	antīki brūns	antiik-pruun
auriu antic	staro zlato	staro zlato	staro zlato	антично златен	antikos auksinē	antīks zelts	antiik-kuld
alb antichizat	antik bela	antik bijela	antik bela	антично бяло	antikos balta	antīki balts	antiik-valge
negru	crno	crno	črno	черен	juoda	melns	must
albastru	plavo	plavo	modro	син	mėlyna	zils	sinine
maro	smeđa	braun	rjavo	кафяв	ruda	brūns	pruun
aluminiu șlefuit	brušeni aluminijum	strugani aluminij	brušen aluminij	драскан алуминий	braižyto aliuminio	matēts alumīnijs	harjatud alumiinium
culoare caramel	караemel боја	karamela boja	barva karamela	кара멜ен цвят	karamellkrāsa	karamelinē spalva	karamellivärv
crom	hrom	krom	krom	хром	chrominē	hroms	kroom
verde	zeleno	zeleno	zeleno	зелен	žalia	zaļš	roheline
gri	sivo	sivo	sivo	сив	pilka	pelēks	hall
mat negru	mat crno	mat crno	mat črno	мат-черен	matinē juoda	matēti melns	matt must
mat alb	mat belo	mat bijelo	medlobel	мат-бял	matinē balta	matēti balts	matt valge
multicolor	višebojno	višebojno	večbarvno	многоцветен	įvairiaspalvė	daudzkrāsains	mitmevärviline
stejar	hrast	hrast	hrast	дъб	ąžuolo	ozols	tamm
sticlă opal	opal staklo	opal staklo	opalno steklo	опалово стъкло	opalinio stiklo	opāla stikls	opaalklaas
roșu	crveno	crveno	rdeče	червен	raudona	sarkans	punane
crom satin	satnasti hrom	satnasti krom	satnast krom	сатенен-хром	atlaso chrominē	satīna hroms	satiin-kroom
argintiu	srebrno	srebrno	srebrno	сребърен	sidabrinē	sudraba	hõbe
fumuriu	boje dima	indigo plava	barva dima	прозиращо кафяво	su atspalviu	tonēta krāsa	toonitud värv
transparent	providan	proziran	prozorno	прозрачен	skaidri	caurspīdīgs	läbipaistev
alb	belo	bijelo	belo	бял	balta	balts	valge

KEY OF SYMBOLS • JELMAGYARÁZAT • ZEICHENERKLÄRUNG



GBR



HUN



GER



FRA



CZE



SVK



POL



UKR

	Key of symbols	Jelmagyarázat	Zeichenerklärung	Légende	Legenda	Legenda	Objasnenie znakov	позначення умовних
	item number of spare lampshade	pótbúra cikkszám	Artikelnummer Zusatzschirm	no. d'article du globe supplémentaire	položkové číslo náhradního krytu	číslo položky náhradného tienidla	numer indeksu klosza zapasowego	артикульний номер запасного абажура
	external replacement lampshade item number	külső pótbúra cikkszám	Artikelnummer äußerer Zusatzschirm	numéro d'article globe supplémentaire extérieur	položkové číslo vnějšího náhradního krytu	číslo položky vonkajšieho náhradného tienidla	numer indeksu zewnetrznego klosza zapasowego	артикульний номер зовнішнього запасного абажура
	with light source	fényforrással együtt	mit Leuchtmittel	avec source lumineuse	se světelným zdrojem	spolu so svetelným zdrojom	z źródłem światła	разом з джерелом світла
	without light source	fényforrás nélkül	ohne Leuchtmittel	sans source lumineuse	bez světelného zdroje	bez svetelného zdroja	bez źródła światła	без джерела світла
	with switch	kapcsolóval	mit Schalter	avec commutateur	se spínačem	so spínačom	z wyłącznikiem	із перемикачем
	mounting depth	beépítési mélység	Einbautiefe	profondeur de montage	montážní hloubka	montážna hĺbka	głębokość montażowa	глибина кріплення
	motion sensor	mozgásérzékelő	Bewegungssensor	détecteur mouvement	senzor pohybu	senzor pohybu	czujnik ruchu	датчик руху
	remote controller item number	távírányító cikkszám	Artikelnummer der Fernbedienung	numéro d'article de la télécommande	Číslo položky dálkového ovladače	Číslo položky diaľkového ovládača	Numer produktu pilota	Номер елемента дистанційного керування
	Lumen with shade	Lumen adat burával	Lumen mit Schatten	Lumen avec abat-jour	Lumen se stíněním	Lumen s odtieňom	Lumen z cieniem	Люмен з плафоном
	Lumen without shade	Lumen adat búra nélkül	Lumen ohne Schatten	Lumen sans abat-jour	Lumen bez stínu	Lumen bez tieňa	Światło bez cienia	Люмен без тіні

	Lamp made of	Lámpa anyaga	Lampenmaterial	Le matériel de la lampe	Materiál lampy	Materiál svetidla	Materiał oprawy	Матеріал світильника
	metal	fém	Metall	métal	kov	kov	metal	метал
	glass	üveg	Glas	verre	sklo	sklo	szkło	скло
	plastic	műanyag	Kunststoff	plastique	plast	umělá hmota	tworzywo sztuczne	пластмаса

	Further key	Egyéb magyarázat	Weitere Erklärungen	Autres explications	jiné vysvětlení	druga razlaga	inne wytłumaczenie	інше пояснення
excl.	excluded	nem tartalmaz	exklusive	excepté	neobsahuje	neobsahuje	nie zawiera	не містить
incl.	included	tartalmaz	inklusive	inclus	obsah	obsahuje	zawiera	містить



ROM



SRB



CRO



SLO



BUL



LTU



LVA



EST

	Legendă	Objasnenje znakov	Tumač znakova	Legenda	Обяснение на условни знаци	Aprašas	Apzīmējumi	Tingmärk
	număr articol abajur suplimentar	oznaka dodatnog abažura	oznaka dodatnog sjenila	koda dodatnega abažura	резервен абажур артикул №	atsarginio gaubto prekės Nr.	maišas abažūra izstrādājuma Nr.	asenduslambikuppel nr
	număr articol abajur suplimentar pentru exterior	oznaka dodatnog spoljnog abažura	oznaka dodatnog vanjskog sjenila	oznaka dodatnega zunanjega abažura	вншен резервен абажур артикул №	išorinio atsarginio gaubto prekės Nr.	ārējā maišas abažūra izstrādājuma Nr.	vāline asenduslambikuppel nr
	cu sursă de lumină	zajedno sa izvorom svetlosti	zajedno s izvorom svjetlosti	skupaj z virom svetlobe	включительно светлинен източник	kartu su šviesos šaltiniu	kopā ar gaismas avotu	koos valgusalikaga
	fără sursă de lumină	bez izvora svetlosti	bez izvora svjetlosti	brez svetlobnega vira	без светлинен източник	be šviesos šaltinio	bez gaismas avota	valgusalikata
	cu întrerupător	sa prekidačem	s prekidačem	s stikalom	с превключател	su jungikliu	ar slēdzi	lūlitiga
	adâncimea de montare	dubina ugradnje	instalacijske ugradnje	globina montaže	дълбочина на монтаж	įmontavimo gylis	iebūvēts dziļums	sisseehitatud sügavus
	senzor de mișcare	senzor kretanja	senzor kretanja	senzor gibanja	със сензор за движение	judesio jutiklis	kustības sensors	liikumisandur
	Număr articol pe telecomandă	Broj stavke daljinskog upravljača	Broj stavke daljinskog upravljača	Številka izdelka daljinskega upravljalnika	Каталожен номер на дистанционното управление	Nuotolinio valdymo pulto prekės numeris	Tālvadības pults vienuma numurs	Puldi artiklinumber
	Lumen cu umbră	Lumen sa senkom	Lumen sa sjenom	Lumen s senco	Люмен със сянка	Lumenas su šešėliu	Lūmenis ar ēnu	Varjuga luumen
	Lumen fără umbră	Lumen bez senke	Lumen bez sjene	Lumen brez sence	Люмен без сянка	Lumenas be šešėlio	Lūmenis bez ēnas	Valendik ilma varjuta

	Materialul lămpi	Materijal svetiljke	Materijal rasvetnog tijela	Material izdelka	Лампата е произведена от	Šviestuvo medžiaga	Lampas materiāls	Lambi materjal
	metal	metal	metal	kovinski	метал	metalinė	metāla	metalli
	sticlă	staklo	staklo	steklo	стъкло	stiklas	stikls	klaas
	plastic	plastična	plastika	umetna masa	пластмаса	plastikas	plastmasa	plast

	alte explicații	Druga objašnjenja	Druga objašnjenja	iné vysvetlenie	други обяснения	Kiti simboliai	Citi simboli	Muud sümbolid
excl.	nu conține/he este inclus	ne sadržava	Ne sadrži	brez (ne vsebuje)	не е включено	neturi	nesatur	ei sisalda
incl.	conține/include	sadržava	sadržava	vsebujejo	включено е	yra su	satur	sisaldab

KEY OF SYMBOLS • JELMAGYARÁZAT • ZEICHENERKLÄRUNG



new/új/neu	Symbols	Jelölések	Bezeichnungen	Symboles	Jména
	new	új	neu	nouveau	nový
	designed by Rabalux	Rábalux saját design	entworfen von Rabalux	conçu par Rabalux	Rábalux vlastní design
	Lightsource recommendation	Fényforrás ajánló	Lichtquellenempfehlung	Recommandation de source lumineuse	Doporučený světelný zdroj
	5 years guarantee	5 év garancia	5 Jahre Garantie	5 ans de garantie	záruka 5 let
	built-in LED	BEÉPÍTETT LED	LED inklusive	LED inclus	obsahuje LED
	LED included	LED-et tartalmaz	LED inklusive	LED inclus	obsahuje LED
	Smart product	Okos termék	intelligentes Produkt	produit intelligent	chytrý produkt
	Wi-Fi	Wi-Fi	Wi-Fi	Wi-Fi	Wi-Fi
	warm white light	meleg fehér fényű	warmweiß	blanc chaud	teplá bílá
	natural white light	természetes fehér fényű	naturweiß	blanc naturel	přirozená bílá
	daylight	napfény	Tageslicht	lumière du jour	denní světlo
	cool white light	hideg fehér fényű	kaltweiß	blanc froid	studená bílá
	colour temperature variable with remote control	távírányítóval állítható színhőmérséklet	Mit fernbedienung einstellbare Farbtemperatur	Température de couleur réglable par télécommande	Nastavení teploty chromatičnosti dálkovým ovladačem
	adjustable colour temperature	állítható színhőmérséklet	einstellbare Farbtemperatur	température de couleur réglable	nastavitelná teplota barev
	colour temperature variable with touch switch	érintőkapcsolóval állítható színhőmérséklet	Mit Berührungschalter einstellbare Farbtemperatur	température de couleur variable avec interrupteur tactile	změna teploty barvy světla pomocí dotykového spínače
	Color temperature can be adjusted in 3 steps with a switch	Kapcsolóval 3 lépésben szabályozható színhőmérséklet	Die Farbtemperatur kann mit einem Schalter in 3 Stufen eingestellt werden	La température de couleur peut être ajustée en 3 étapes avec un interrupteur	Teplotu barev lze nastavit pomocí přepínače ve 3 krocích
	Color temperature can be adjusted in 3 steps with remote control	Távírányítóval 3 lépésben szabályozható színhőmérséklet	Die Farbtemperatur kann mit einer Fernbedienung in 3 Stufen eingestellt werden	La température de couleur peut être ajustée en 3 étapes avec une télécommande	Barevnou teplotu lze ovládat ve 3 krocích pomocí dálkového ovladače
	Color temperature can be adjusted in three steps with a touch switch	Érintőkapcsolóval három lépésben szabályozható színhőmérséklet	Die Farbtemperatur kann in drei Stufen mit einem Touch-Schalter eingestellt werden	La température de couleur peut être ajustée en trois étapes avec un interrupteur tactile	Teplotu barev lze upravit ve třech krocích dotykovým spínačem
	Color temperature can be adjusted in 3 steps with a DIP switch	DIP kapcsolóval 3 lépésben szabályozható színhőmérséklet	Die Farbtemperatur kann mit einem DIP Schalter in 3 Stufen eingestellt werden	La température de couleur peut être ajustée en 3 étapes avec un interrupteur DIP	Teplotu barev lze nastavit pomocí DIP přepínače ve 3 krocích
	RGB colour change LED	RGB színváltós LED	Farbwechsel-LED	LED à changement de couleurs	LED diody střídající barvu

KEY OF SYMBOLS • JELMAGYARÁZAT • ZEICHENERKLÄRUNG



new/új/neu	Označenia	Oznaczenia	Позначення	Simboluri	Označavanje
	Nový	nowy	новий	nou	novo
	Rabalux vlastný dizajn	Zaprojektowano przez Rabalux	розроблений Rabalux	designed de Rabalux	Rabalux dizajn
	Odporúčanie svetelného zdroja	Rekomendowane źródło światła	Рекомендація щодо джерела світла	Recomandare sursa de lumina	preporuka za tip sijalice
	Záruka 5 rokov	5-letnia gwarancja	гарантія 5 років	5 ani garanție	5 godina garancije
	obsahuje LED diódy	Dioda LED w wyposażeniu	містить світлодіоди	LED încorporat	ugrađeni LED
	obsahuje LED diódy	Dioda LED w wyposażeniu	містить світлодіоди	LED inclus	sa LED diodom
	inteligentný produkt	inteligentny produkt	розумний продукт	produs inteligent	паметан производ
	Wi-Fi	Wi-Fi	Wi-Fi	Wi-Fi	Wi-Fi
	teplá biela	ciepła biała	теплий білий	alb cald	toplo bela
	prírodná biela	naturalna biała	натуральний білий	alb natural	prirodno bela
	denné svetlo	światło dzienne	денне світло	lumină naturală	dnevna svetlost
	studená biela	zimna biała	холодний білий	alb rece	hladno bela
	Možnosť nastavenia teploty farieb s diaľkovým ovládačom	Zmienna temperatura barwowa za pomocą pilota	Регулювання колірної температури через пульт дистанційного керування	Temperatura culorii reglabilă de la telecomandă	Sa daljinskim prekidačem može da se podesi temperatura boja
	nastaviteľná teplota farieb	Można regulować temperaturę barwową	регульована колірна температура	Temperatura de culoare reglabilă	podესiva temperatura boje
	nastaviteľná farebná teplota s dotykovým spínačom	Regulacja temperatury światła za pomocą włącznika dotykowego	Колір світла змінюється доторканням	temperatura variabilă a culorii cu comutator tactil	Temperatura svetla, podесiva putem prekidača na dodir
	Farebnú teplotu je možné nastaviť v 3 krokoch pomocou prepínača	Temperaturę barwową można regulować w 3 krokach za pomocą przełącznika	Колірну температуру можна регулювати в 3 кроки за допомогою перемикача	Temperatura de culoare poate fi reglată în 3 trepte cu un comutator	Температура боје се може подесити у 3 корака помоћу прекидача
	Farebnú teplotu je možné nastaviť v 3 krokoch pomocou diaľkového ovládača	Temperaturę barwową można regulować w 3 krokach za pomocą pilota	Колірну температуру можна регулювати в 3 кроки за допомогою пульта дистанційного керування	Temperatura de culoare poate fi reglată în 3 trepte cu ajutorul telecomenzii	Температура боје се може подесити у 3 корака помоћу далјинског управљача
	Teplotu farby je možné nastaviť v troch krokoch pomocou dotykového spínača	Temperaturę barwową można regulować w trzech krokach za pomocą przełącznika dotykowego	Колірну температуру можна регулювати в три етапи за допомогою сенсорного перемикача	Temperatura culorii poate fi ajustată în trei pași cu un comutator tactil	Температура боје се може подесити у три корака помоћу прекидача на додир
	Farebnú teplotu je možné nastaviť v 3 krokoch pomocou prepínača DIP	Temperaturę barwową można regulować w 3 krokach za pomocą przełącznika DIP	Колірну температуру можна регулювати в 3 кроки за допомогою DIP-перемикача	Temperatura de culoare poate fi reglată în 3 trepte cu un comutator DIP	Температура боје се може подесити у 3 корака помоћу ДИП прекидача
	LED s meniacou sa farbou	Zmieniający kolor LED	Світлодіоди зі зміною кольору	LED RGB	LED sa promenjivim bojama

KEY OF SYMBOLS • JELMAGYARÁZAT • ZEICHENERKLÄRUNG



CRO



SLO



BUL



LTU



LVA



EST

new/új/neu	Oznake	Oznake	Символи	Simboliai	Simboli	Sümbolid
	novo	novo	ново	naujas	jauns	uus
	dizajnirao Rablux	zasnoval Rabalux	проектирано от Rabalux	suprojektavo „Rabalux“	izstrādājis Rabalux	Rabaluxi disain
	Preporuka izvora svjetla	Odporúčanie svetelného zdroja	Препоръка за източник на светлина	Šviesos šaltinio rekomendacija	leteikums par gaismas avotu	Valgusallika soovitus
	5 godina jamstva	5 let garancije	5 години гаранция	5 metų garantija	5 gadu garantija	5-aastane garantii
	ugrađeni LED	vgrajen LED	вграден LED	įmontuotas LED įrenginys	ieibūvēta LED	sisse-ehitatud LED
	sadrži LED	vsebuje LED	с включен LED	LED pridedama	LED iekļauta komplektā	LED on kaasas
	pametan proizvod	pameten izdelek	интелигентен продукт	protingas produktas	gudrs produkts	tark toode
	Wi-Fi	Wi-Fi	Wi-Fi	Wi-Fi	Wi-Fi	Wi-Fi
	toplo bijelo	toplo bela	топло бяло	šiltai balta	silti balts	soe valge
	prirodno bijelo	naravno bela	естествено бяло	natūraliai balta	dabīgi balts	loomulik valge
	dnevno svjetlo	dnevna svetloba	дневна светлина	dienos šviesa	dienasgaisma	päevavalgus
	hladno bijelo	hladno bela	студено бяло	šaltai balta	vēsi balts	külm valge
	Pomoću daljinskog prekidača možete podesiti temperaturu boje	Barvno temperaturo lahko nastavite z daljinskim stikalom	Регулиране на цветната температура с дистанционно управление	Kintanti spalvinė temperatūra su nuotoliniu pulteliu	Maināma krāsu temperatūra ar tālvadības pulti	Muutuv värvustemperatuur kaugjuhtimisega
	podesiva temperatura boje	nastavljiva barvna temperatura	регулируема цветна температура	reguliuojama temperatūra	regulējama krāsu temperatūra	reguleeritav värvustemperatuur
	Temperatura boje podesiva prekidačem na dodir	sprememba barvne temperature s stikalom na dotik	промяната на цветната температура с докосване	Prilietimu keičiama spalvos temperatūra	Krāsu temperatūras mainīgais ar skārienekrānu	puutөлүлүтist muudetav värvustemperatuur
	Temperatura boje može se podesiti u 3 koraka pomoću prekidača	Barvno temperaturo lahko nastavite v 3 korakih s stikalom	Цветовата температура може да се регулира на 3 стъпки с превключвател	Spalvos temperatūrą galima reguliuoti 3 žingsniais jungikliu	Krāsu temperatūru var regulēt 3 soļos ar slēdzi	Värvustemperatuuri saab lülilitiga reguleerida 3 astmes
	Temperatura boje može se podesiti u 3 koraka daljinskim upravljačem	Barvno temperaturo lahko nastavite v 3 korakih z daljinskim upravljalnikom	Цветовата температура може да се регулира в 3 стъпки с дистанционното управление	Spalvos temperatūrą nuotolinio valdymo pulteliu galima reguliuoti 3 žingsniais	Krāsu temperatūru var regulēt 3 soļos ar tālvadības pulti	Värvustemperatuuri saab kaugjuhtimisepuldiga 3-astmeliselt reguleerida
	Temperatura boje može se podesiti u tri koraka pomoću prekidača na dodir	Barvno temperaturo lahko nastavite v treh korakih s stikalom na dotik	Цветовата температура може да се регулира на три стъпки с сензорен превключвател	Spalvos temperatūrą galima reguliuoti trimis žingsniais jutikliu	Krāsu temperatūru var regulēt trīs soļos ar skārienslēdzi	Värvustemperatuuri saab puutөлүлүтitiga kolmes astmes reguleerida
	Temperatura boje može se podesiti u 3 koraka pomoću DIP prekidača	Barvno temperaturo lahko nastavite v 3 korakih s DIP stikalom	Цветовата температура може да се регулира на 3 стъпки с DIP превключвател	Spalvos temperatūrą galima reguliuoti 3 žingsniais DIP jungikliu	Krāsu temperatūru var regulēt 3 soļos ar DIP slēdzi	Värvustemperatuuri saab DIP-lülilitiga reguleerida 3 astmes
	LED s promjenjivim bojama	LED diode s spremenljivim barvama	LED с променлива светлина	Spalvą keičiantis LED	Maināmas krāsas LED	Värvi vahetav LED

KEY OF SYMBOLS • JELMAGYARÁZAT • ZEICHENERKLÄRUNG



GBR



HUN



GER



FRA



CZE



SVK

new/új/neu	Symbols	Jelölések	Bezeichnungen	Symboles	Jména	Označenia
	adjustable brightness in 3 steps with switch	Kapcsolóval 3 lépésben szabályozható fényerő	Einstellbare Helligkeit mit Schalter in 3 Stufen	Luminosité ajustable avec interrupteur à 3 positions	Nastavitelný jas pomocí spínače ve 3 krocích	Nastavitelný jas pomocou spínača v 3 krokoch
	adjustable brightness in 3 steps with touch switch	Érintőkapcsolóval több lépésben szabályozható fényerő	Einstellbare Helligkeit mit Touch-Schalter in 3 Stufen	Luminosité ajustable avec interrupteur tactile à 3 positions	Nastavitelný jas s dotykovým spínačem ve 3 krocích	Nastavitelný jas s dotykovým spínačom v 3 krokoch
	with switch	kapcsolóval	mit Schalter	avec commutateur	se spínačem	so spínačom
	Remote control	Távírányítóval	Fernbedienung	Télécommande	Dálkové ovládání	Diaľkový ovládač
	touch switch dimmer	érintőkapcsolóval szabályozható fényerő	Touchbutton-Lichtstärkeregler	réglage de la luminosité avec interrupteur tactile	nastavení jasu dotykovým spínačem	dotykový spínač na regulácia intenzity svetla
	light intensity variable only with remote control	csak távírányítóval állítható fényerő	Lichtintensität nur mit Fernbedienung einstellbar	intensité lumineuse variable uniquement avec télécommande	intenzitu světla lze nastavit pouze pomocí dálkového ovládání	možnosť nastavenia intenzity svetla iba s diaľkovým ovládačom
	dimnable	szabályozható fényerő	Lichtstärke Regler	Regleur d'intensité de la lumière	regulátor jasu	regulátor jasu
	motion sensor	mozgásérzékelő	Bewegungssensor	détecteur mouvement	senzor pohybu	senzor pohybu
	microwave sensor	mikrohullámú mozgásérzékelő	Mikrowellen-Sensor	Capteur à micro-ondes	mikrovlnný snímač	Mikrovlnný snímač
	illuminates upwards	felfelé világít	leuchtet nach oben	éclaire vers le haut	svítí nahoru	svieti nahor
	illuminates downwards	lefelé világít	leuchtet nach unten	éclaire vers le bas	směr svícení dolů	svieti smerom dole
	illuminates downwards and upwards	lefelé és felfelé is világít	leuchtet nach oben und nach unten	éclaire vers le bas et vers le haut	směr svícení nahoru i dolů	svieti smerom dole aj hore
	environmentally friendly	környezetbarát	umweltschonend	écologique	je šetrný k životnímu prostředí	šetrný k životnému prostrediu
	light reactive, only illuminates in the dark	fényérzékelő lámpa, csak sötétben világít	mit Helligkeitssensor, leuchtet nur im Dunkeln	l'appareil est muni d'un photodétecteur, il ne se manifestera que s'il est plongé dans l'obscurité	se světelným senzorem, svítí pouze ve tmě	so svetelným senzorem, svieti iba v tme
	UV resistant plastic	UV álló műanyag	UV-beständiger Kunststoff	plastique résistant à l'UV	plast odolný UV záření	plast odolný UV žiareniu
	lamp operating with solar cells	napelemmel működő lámpa	Leuchte funktioniert über Solarzellen	luminaire fonctionnant avec une cellule photovoltaïque	svítidlo na solární baterii	plast odolný UV
	IP protection	IP védettség	IP-Klasse	protection IP	IP krytí	IP ochrana
	IP protection of built-in lamp	beépített lámpa IP védelme	IP-Schutz der eingebauten Lampe	protection IP de la lampe intégrée	IP krytí zabudovaného svítidla	IP ochrana zabudovanej lampy
	indirect light	indirekt fény	mit indirektem Licht	à lumière indirecte	s nepřímým světlem	s nepriamym svetlom
	backlight effect	háttérfény funkció	Hintergrundlichteffekt	effet de contre-jour	efekt podsvícení	efekt podsvietenia

KEY OF SYMBOLS • JELMAGYARÁZAT • ZEICHENERKLÄRUNG



new/új/neu	Oznaczenia	Позначення	Simboluri	Označavanje	Oznake
	Jasność dostosowywana przełącznikiem w 3 krokach	Регульована яскравість з перемикачем в 3 кроки	Luminozitate ajustabilă prin comutator în 3 trepte	Podesivo osvetljenje u 3 koraka uz pomoć prekidača	Prilagodljiva svjetlina s prekidačem u tri koraka
	Jasność dostosowywana dotykowo w 3 krokach	Регульована яскравість з сенсорним перемикачем в 3 кроки	Luminozitate ajustabilă prin atingere, în 3 trepte	Podesivo osvetljenje u 3 koraka uz pomoć prekidača koji se aktivira dodirom	Prilagodljiva svjetlina s dodirnim prekidačem u tri koraka
	z włącznikiem	із перемикачем	cu întrerupător	sa prekidačem	s prekidačem
	Pilot zdalnego sterowania	Дистанційне керування	Telecomandă	Dalečinski upravljač	Daljinski upravljač
	ściemniacz dotykowy	сенсорний диммер	senzor tactil pentru reglarea luminozității	podešavanje jačine svetlosti sa prekidačem na dodir	podešavanje svjetline pomoću dodirne sklopke
	natężenie światła regulowane tylko przy pomocy pilota	інтенсивність світла регулюється тільки за допомогою пульта	Intensitate variabilă a luminii numai de la telecomandă	Intenzitet svetlosti podesiv samo uz pomoć daljinskog upravljača	jačina svjetla promjenjiva samo sa daljinskim upravljačem
	regulator natężenia światła	регулятор потужності світла	regulator intensitate lumina	regulator svetlosti	regulator jačie svjetla
	czujnik ruchu	датчик руху	senzor de mișcare	senzor kretanja	senzor kretanja
	Mikrofalowy czujnik ruchu	Мікрохвильовий датчик	Senzor cu microunde	Mikrotalasni senzor	Mikrovalni senzor
	świeci do góry	світиться вгору	iluminează în sus	svetli prema gore	osvjetljava prema gore
	świeci w dół	напря́м світла донизу	luminează în jos	nadole svetli	svijetli nadolje
	świeci w dół i w górę	напря́м світла донизу і догори	luminează în jos și în sus	svetli i nagore i nadole	svijetli i nadolje i nagore
	Przyjazny dla środowiska	безпечний для довкілля	ecologic	ekološki prihvatljiv	ekološki prihvatljiv
	z czujnikiem oświetlenia, świeci tylko w ciemności	оснащений сутінковим світловим вмикачем, включається тільки при зниженні інтенсивності освітлення	cu sensor, luminează doar în întuneric	osjetljiv na svetlost, svetli samo u mraku	osjetljiv na svjetlost, svijetli samo u mraku
	tworzywo sztuczne odporne na UV	УФ-стійкий пластик	material plastic rezistent la UV	UV otporna plastika	Plastika otporna na UV zrake
	lampa zasilana energią słoneczną	лампа на сонячній батареї	lampă cu acumulator solar	solarna lampa	solarna svjetiljka
	Stopień ochrony IP	Клас IP-захисту	Protecția IP	IP zaštita	IP zaštita
	wbudowana ochrona IP	IP-захист вбудованої лампи	Protecția IP a lămpii încorporate	IP zaštita ugrađene lampe	IP zaštita ugrađene svjetiljke
	ze światłem pośrednim	з непря́ним освітленням	cu lumină indirectă	sa indirektnim svetlom	s neizravnim svjetlom
	efekt podświetlenia	ефект підсвічування	efect iluminare de fundal	pozadinsko osvetljenje	efekt pozadinskog svjetla

KEY OF SYMBOLS • JELMAGYARÁZAT • ZEICHENERKLÄRUNG



new/új/neu	Oznake	Символи	Simboliai	Simboli	Sümbolid
	Prilagodljiva svetlost s stikalom v 3 korakih	Регулируема яркост с ключ на 3 степени	Ryškumas reguliuojamas su jungikliu 3 žingsniais	Trīs līmeņu regulējams spilgtums ar slēdzi	Lülitist 3-astmeliselt reguleeritav heledus
	Prilagodljiva svetlost s stikalom na dotik v 3 korakih	Регулируема яркост с ключ с докосване на 3 степени	Ryškumas reguliuojamas su jutikliniu jungikliu 3 žingsniais	Trīs līmeņu regulējams spilgtums ar skārienjūtīgu slēdzi	Puutelülitist 3-astmeliselt reguleeritav heledus
	s stikalom	с превключвател	su jungikliu	ar slēdzi	lülitiga
	Daljinski upravljalnik	Дистанционно управление	Nuotolinio valdymo pultas	Tālvadības pults	Pult kaugjuhtimiseks
	Prilagodite svetlost z stikalom na dotik	регулатор на яркостта със сензорен превключвател	liečiamasis pritemdymo jutiklis	skārienjutīgs gaismaiņa slēdzis	puutetundlik valgusregulaator
	možnost nastavitve jakosti svetlobe samo z daljinskim upravljanjem	диммиране само чрез дистанционно управление	tik šviesos stiprio kintamasis su nuotolinio valdymo pultu	gaismas intensitāte mainīga tikai ar tālvadības pulti	valguse intensiivsust saab reguleerida ainult kaugjuhtimispuldi abil
	zatemnilnik	с регулатор за силата на светлина	pritemdymo įtaisas	gaismmainis	hāmardi
	senzor gibanja	със сензор за движение	judesio jutiklis	kustības sensors	liikumisandur
	Mikrovalovni senzor	Микровълнов сензор	Mikrobangų jutiklis	Mikrovļņu sensors	Mikrolaineandur
	sveti navzgor	свети нагоре	šviesa nukreipta į viršų	iedegas uz augšu	valgustab ūlespoole
	svetli navzdol	осветява надолу	šviečia žemyn	apgaismo lejup	valgustab allapoole
	svetel in gor in dol	осветява надолу и нагоре	šviečia žemyn ir aukštyn	apgaismo lejup un augšup	valgustab alla- ja ūlespoole
	okolju prijazno	щадящ околната среда	draugiškas aplinkai	videi draudzīgs	keskkonnasõbralik
	občutljivo na svetlobo, sveti le v temi	реагира на светлина, светва само, когато е тъмно	reaguoja į šviesą, užsidega tik tamsoje	reaģējošs uz gaismu, apgaismo tikai tumsā	valgusreaktiivne, valgustab vaid pimedas
	Plastika UV-odporen	устойчива на UV лъчи пластмаса	UV atsparus plastikas	pret UV stariem noturīga plastmasa	UV-kindel plastik
	sončna svetilka	лампа, работеща със слънчеви батерии	veikia su saulės energijos skydeliu	darbojas ar saules bateriju	sisselūlitamine pāikeseleemendīga
	IP zaščita	с IP защита	IP klasė	IP aizsardzība	IP kaitse
	IP zaščita vgrajene svetilke	IP защита на вградена лампа	IP saugumo lygio įmontuotas šviestuvai	iebūvētās lampas IP aizsardzība	sisse-ehitatud valgusti IP-kaitse
	s posredno svetlobo	с индиректна светлина	su netiesiogine šviesa	ar netiešu gaismu	kaudvalgusega
	učinek osvetlitve	ефект на подсветка	foninio apšvietimo efektas	aizmugurapgaismojuma efekts	tagantvalgustuse efekt

KEY OF SYMBOLS • JELMAGYARÁZAT • ZEICHENERKLÄRUNG



new/új/neu	Symbols	Jelölések	Bezeichnungen	Symboles	Jména
	adjustable sensor	állítható érzékelő	verstellbarer Sensor	capteur réglable	nastavitelný senzor
	moveable heads	mozgatható fej	bewegliche Köpfe	têtes mobiles	pohyblivé hlavy
	Infrared remote	infravörös távirányító	Infrarotfernbedienung	Télécommande infrarouge	Infračervené dálkové ovládání
	plastic	műanyag	Plastik (Kunststoff)	plastique	plast
	starlight effect	csillogó effekt	Glitzereffekt	effet scintillant	efekt jiskření
	timer function	IDŐZÍTŐ FUNKCIÓ	mit einer Zeitfunktion	avec fonction de temps	s časovačem
	night light function	éjszakai funkció	Nachtfunktion	fonction nuit	funkce nočního světla
	memory function	memória funkció	Speicherfunktion	fonction mémoire	funkce pamět
	can be controlled via Bluetooth	vezérlés Bluetooth kapcsolaton keresztül	Steuerung über Bluetooth	commande via liaison Bluetooth	ovládání prostřednictvím Bluetooth kontaktu
	micro-USB included	micro-USB tartozék	Micro-USB Zubehör	Avec Micro USB livré	Micro-USB v příslušenství
	battery excluded	elemet nem tartalmaz	ohne Batterie	pile non incluse	baterie není součástí balení
	battery included	elemet tartalmaz	inklusive Batterie	pile incluse	součástí balení je baterie
	IK08 strong diffuser	búra mechanikus ütődés elleni védelem 08	Schlagfestigkeit IK08	Diffuseur puissant IK08	Odolnost proti nárazu IK08
	Equipped with SCHUKO Type F, CEE 7/4 power connector socket. Not available for CZ, SK and PL.	SCHUKO Type F, CEE 7/4 hálózati csatlakozó aljzattal. Nem rendelhető: CZ, SK és PL.	Mit SCHUKO Netzstecker Typ F, CEE 7/4. Nicht bestellbar in: CZ, SK und PL	SCHUKO Type F, avec douille CEE 7/4. Ne peut être commandé : CZ, SK et PL	SCHUKO Type F, CEE 7/4 se síťovou zásuvkou. Nelze objednat: CZ, SK a PL
	cuttable	vágható	schneidbar	découpable	řezatelný
	not suitable for cutting	nem vágható	nicht zerschneidbar	ne peut pas être coupé	nelze stříhat
	Number of LED diodes per metre	LED diódák száma méterenként	Anzahl der LED-Dioden pro Meter	Nombre de diodes DEL par mètre	Počet LED diod na metr
	2 in 1	kettő az egyben	2 in 1	2 en 1	2 v 1
	delivery unit	szállítási egység	Liefereinheit	unité de transport	dodací jednotka
	Cannot be ordered and cannot be delivered to Slovakia, Czech Republic, Poland.	Nem rendelhető és nem szállítható Szlovákiába, Csehországba, Lengyelországba.	Kann in der Slowakei, der Tschechischen Republik und in Polen nicht bestellt und nicht geliefert werden	Ne peut pas être commandé et ne peut pas être livré en Slovaquie, en République tchèque ni en Pologne	Není možné objednat a nemůže být doručeno na Slovensko, do České republiky, Poľska

KEY OF SYMBOLS • JELMAGYARÁZAT • ZEICHENERKLÄRUNG



new/új/neu	Označenia	Oznaczenia	Позначення	Simboluri	Označavanje
	nastavitel'nyj senzor	regulowany czujnik	регульований датчик	senzor reglabil	podesivi senzor
	pohyblivé hlavy	ruchome głowy	рухомі голови	capete mobile	покретне главе
	Infračervené diaľkové ovládanie	Pilot na podczerwień	Інфрачервоний пульт	Telecomandă cu infraroșu	Infracrveni daljinski
	plast	wykonane z plastiku	пластик	plastic	plastika
	efekt iskrenia	efekt iskrzenia	мерехтливий ефект	efect strălucitor	efekt svetlucanja
	s časovačom	z funkcją timera	з функцією таймера	cu temporizator	sa vremenskom funkcijom
	funkcia nočného svetla	Funkcja światła nocnego	функція нічника	Funcție lumina de noapte	funkcija noćno svetlo
	funkcia pamäte	Funkcja pamięci	функція пам'яті	Funcție de memorie	funkcija pamćenja
	riadenie prostredníctvom Bluetooth pripojenia	sterowanie przez połączenie Bluetooth	керування через Bluetooth	operare prin conexiune Bluetooth	upravljanje preko Bluetooth veze
	Príslušenstvo Micro-USB	Micro-USB w zestawie	Містить мікро-USB	Accesoriu Micro-USB	Mikro-USB dodatna oprema
	batéria nie je súčasťou balenia	Nie zawiera baterii	батарея не додається	bateria nu e inclusă	bez baterije
	súčasťou balenia je batéria	Bateria w zestawie	батарея додається	bateria este inclusă	baterija u opremi
	silný difúzor IK08	Ochrona przed uderzeniami mechanicznymi IK08	Захист від механічного пошкодження плафону IK08	Difuzor puternic IK08	IK08 čvrst difuzor
	SCHUKO Type F, CEE 7/4 so sieťovou zásuvkou. Nie je možné objednať: CZ, SK a PL	Z gniazdem zasilania SCHUKO Type F, CEE 7/4. Brak możliwości zamawiania: CZ, SK i PL	SCHUKO Type F, з гніздом живлення CEE 7/4. Неможливо замовляти: CZ, SK та PL	Cu soclu priză SCHUKO Type F, CEE 7/4. Nu poate fi comandat în CZ, SK și PL	Sa mrežnom priključnicom tipa SCHUKO Type F, CEE 7/4 Ne može da se naruči iz: CZ, SK i PL
	strihateľný	do cięcia	обрізний	tăiat	reziv
	nemožno strihať	cięcie nie jest możliwe	не можна різати	nu poate fi tăiat	ne može se seći
	Počet LED diód na meter	Liczba diod LED na metr	Кількість світлодіодів на метр	Nr. de LED-uri pe metru	Broj LED dioda po metru
	3 v 1	2 w 1	2 в 1	2 în 1	2 u 1
	dodacia jednotka	jednostka logistyczna	одиниця поставки	unitate de livrare	transportna jedinica
	Nie je možné objednať a nemôže byť doručené na Slovensko, do Českej republiky, Poľska	Niedostępne dla zamówienia i dostawy na Słowację, do Czech i Polski	Неможливо замовити та неможливо доставити до Словаччини, Чехії, Польщі	Nu poate fi comandat din și nici livrat în Slovacia, Republica Cehă, Polonia	Ne može da se naruči i ne može da se isporuči u Slovačku, Češku Republiku i Poljsku

KEY OF SYMBOLS • JELMAGYARÁZAT • ZEICHENERKLÄRUNG



new/új/neu	Oznake	Oznake	Символи	Simboliai	Simboli	Sümbolid
	podesivi senzor	nastavljiv senzor	регулируем сензор	reguliuojamas jutiklis	regulējams sensors	reguleeritav andur
	pokretni glave	premične glave	подвижни глави	judamosios galvos	pārvietojamas galvas	liikuvad pead
	Infracrveni daljinski upravljač	Infrardeči daljinski upravljalnik	Инфрачервено дистанционно	Infraraudonųjų spindulių nuotolinio valdymo pultas	Infrasarkano staru tālvadības pults	Infrapuna kaugjuhtimispuult
	plastika	plastika	пластмаса	plastikinis	plastmasa	plastist
	efekt svjetlucanja	učinek bleščanja	искрящ ефект	žvilgesio efektas	spīguļojošs efekts	sādeleva efektīga
	s vremenskom funkcijom	s časovno funkcijo	с функция за време	su laiko funkcija	ar laika funkciju	ajafunktsiooniga
	funkcija noćnog svjetla	noćna funkcija	функция нощна светлина	naktinio apšvietimo funkcija	nakts apgaismojuma funkcija	öine funktsioon
	funkcija memorije	pomnilna funkcija	функция памет	atminties funkcija	atmiņas funkcija	mālu funktsioon
	upravljanje putem Bluetootha	nadzor prek povezave Bluetooth	управление чрез Bluetooth връзка	Galima valdyti naudojant Bluetooth	Var kontrolēt, izmantojot Bluetooth	Juhitav Bluetooth kaudu
	Mikro USB pribor	Mikro USB-pripomoček	С принадлежност Micro-USB	Priedama „Micro-USB“	Micro-USB iekļauts komplektā	Mikro-USB komplektis
	baterija nije uključena	baterije niso uključene	не е предоставена батерия	be baterijos	baterija neietilpst komplektā	patarei ei kuulu komplekti
	baterija je uključena	baterije so uključene	предоставена батерия	su baterija	baterija ietilpst komplektā	patarei kuulub komplekti
	zaštita od mehaničkih utjecaja	IK08 močan difuzor	Устойчивост на удар IK08	Tvirtumo klasė IK08	IK08 spēcīgs difuzors	IK08 lōģikindluse klassi hajuti
	S mrežnim priključkom tipa SCHUKO Type F, CEE 7/4. Nije moguće naručiti iz: CZ, SK i PL	Z vtičem tipa SCHUKO Type F, CEE 7/4 Ni mogoče naročiti pri: CZ, SK in PL	SCHUKO Type F, захранващо щепселно гнездо CEE 7/4. Не може да се заявява за: CZ, SK и PL	Įmontuotas SCHUKO F tipo CEE 7/4 maitinimo įvesties lizdas. Neprieinama CZ, SK ir PL	Aprīkots ar SCHUKO F tipa, CEE 7/4 strāvas ievades/izvades līgzdu. Nav pieejams CZ, SK un PL	SCHUKO Tüüp F, CEE 7/4 toite sisse/välja pistikuga. Mitte saadaval CZ, SK ja PL jaoks
	režeći	rezljiv	режещ	pjaustomas	lōīgatav	lōīgatud
	ne može se rezati	ni mogoče rezati	не може да се реже	netinka pjaustymui	nav piemērots griešanai	ei sobi lōīkamiseks
	Broj LED dioda po metru	Število LED dioda na meter	Брой светодиоди на метър	Šviesos diodų skaičius viename metre	Diožu skaits uz metru	Valgusdiodeide arv meetri kohta
	2 u 1	2 v 1	2 в 1	Du viename	Divi vienā	Kaks-ühes
	transportna jedinica	transportna enota	транспортна единица	pristatomas įrenginys	piegādes vienība	tarnesse kuulub
	Ne može se naručiti niti isporučiti u Slovačku, Republiku Češku i Poljsku	Ni mogoče naročiti iz in ne more biti dostavljeno na Slovaško, Češko in Poljsko	Не може да бъде поръчано и не може да бъде доставено до Словакия, Чехия, Полша	Negalima užsakyti ir pristatyti į Slovakiją, Čekiją, Lenkiją	Nevar pasūtīt un piegādāt uz Slovākiju, Čehiju un Poliju	Ei saa tellida ja tarnida Slovakkiasse, Tšehhi Vabariiki ja Poolasse

CONTENTS • TARTALOMJEGYZÉK • INHALTSVERZEICHNIS

New	Art. number	Name	Page
Új	Cikkszám	Név	Oldal
Neu	Art. nummer	Name	Seite

New	Art. number	Name	Page
Új	Cikkszám	Név	Oldal
Neu	Art. nummer	Name	Seite

New	Art. number	Name	Page
Új	Cikkszám	Név	Oldal
Neu	Art. nummer	Name	Seite

New	Art. number	Name	Page
Új	Cikkszám	Név	Oldal
Neu	Art. nummer	Name	Seite

	2697	Zenon	93
	2698	Zenon	93
	2699	Zenon	109
	2700	Zenon	109
	3309	Yago	137
	3310	Yago	137
	3437	Lucas	102
	3438	Lucas	102
	3439	Lucas	102
	5274	Coco	87
	5275	Coco	87
	5276	Coco	87
	5810	Lentil	110
	7010	Lentula	145
	7032	Medulin	145
	7040	Odera	141
	7060	Turda	147
	7070	Zaton	136
	7109	Mendoza	82
	7110	Mendoza	82
	7127	Taverna	48
	7128	Taverna	48
	7129	Taverna	48
	7130	Taverna	48
	7146	Paravento	46
	7147	Paravento	46
	7148	Paravento	46
	7149	Paravento	46
	7150	Paravento	46
	7158	Teplice	41
	7159	Teplice	41
	7195	Wales	42
	7196	Wales	42
	7197	Wales	42
	7236	Novigrad	81
	7237	Novigrad	81
	7238	Dubrovnik	49
	7239	Dubrovnik	49
	7240	Dubrovnik	49
	7244	Orlova	81
	7250	Pernik	103
	7265	Pernik	103
	7266	Savano	45
	7267	Savano	45
	7317	Lippa	65
	7318	Lippa	65
	7319	Lippa	65
	7320	Lippa	65
	7379	Ankara	38
	7380	Ankara	38
	7386	Kolta	39
	7387	Kolta	39
	7396	Solin	64
	7397	Solin	64
	7406	Hort	111
	7407	Hort	111
	7408	Hort	111
	7409	Hort	111
	7476	Balimo	70
	7477	Balimo	70
	7478	Balimo	70
	7479	Balimo	70
	7502	Wellington	39

	7503	Wellington	39
	7504	Palanga	32
	7505	Palanga	32
	7506	Palanga	32
	7774	Inverness	89
	7775	Inverness	89
	7796	Opole	83
	7797	Opole	83
	7814	Krobja	147
	7817	Zombor	86
	7818	Zombor	86
	7819	Zombor	86
	7820	Zombor	86
	7826	Lisbon	56
	7827	Lisbon	56
	7828	Lisbon	56
	7829	Lisbon	56
	7836	Madrid	126
	7837	Milano	120
	7850	Yola	145
	7877	Funghetto	164
	7880	Ostrava	157
	7881	Ostrava	157
	7884	Almada	50
	7885	Almada	50
	7887	Buffalo	75
	7888	Buffalo	75
	7891	Silistra	81
	7892	Silistra	81
	7893	Tartu	90
	7894	Tartu	90
	7895	Tartu	90
	7896	Tartu	90
	7897	Tartu	91
	7898	Tartu	91
	7899	Tartu	91
	7900	Tartu	91
	7904	Belfast	37
	7929	Elva	37
	7930	Elva	37
	7935	Halden	72
	7951	Nesna	66
	7952	Nesna	66
	7955	Sintra	80
	7956	Sintra	80
	7959	Mandal	75
	7960	Mandal	75
	7969	Amarillo	148
	7970	Opava	157
	7975	Dannet	167
	7979	Eric	102
	7980	Amarillo	148
	8011	Pueblo	149
	8018	Chile	79
	8019	Chile	79
	8020	Chile	79
	8029	Chile	79
	8030	Chile	79
	8034	Chile	79
	8060	Bona	72
	8104	Bilbao	167
	8118	Phoenix	80
	8119	Phoenix	80

	8130	Navia	61
	8134	Varna	72
	8135	Varna	72
	8145	Blacktorch	52
	8146	Blacktorch	52
	8147	Blacktorch	52
	8148	Blacktorch	52
	8149	Akron	86
	8150	Akron	86
	8154	Follina	61
	8163	Odessa	124
	8164	Odessa	124
	8165	Odessa	124
	8169	Seattle	85
	8170	Stuttgart	105
	8181	Monaco	115
	8182	Monaco	115
	8184	Monaco	115
	8185	Monaco	115
	8186	Monaco	115
	8190	Darius	136
	8201	Velence	122
	8202	Velence	121
	8203	Velence	122
	8204	Velence	121
	8205	Velence	122
	8206	Velence	121
	8207	Velence	122
	8208	Velence	121
	8209	Velence	122
	8210	Velence	121
	8216	Velence	122
	8217	Velence	121
	8218	Velence	123
	8220	Stuttgart	105
	8227	Stuttgart	105
	8229	Seattle	85
	8232	Velence	123
	8234	Velence	123
	8236	Velence	123
	8238	Velence	123
	8240	Velence	123
	8243	Haga	135
	8244	Haga	135
	8245	Konstanz	130
	8246	Konstanz	130
	8247	Konstanz	130
	8248	Konstanz	130
	8261	Inoxtorch	54
	8263	Inoxtorch	54
	8264	Inoxtorch	54
	8265	Inoxtorch	55
	8266	Inoxtorch	55
	8267	Inoxtorch	55
	8268	Inoxtorch	55
	8270	Oslo	132
	8271	Oslo	133
	8337	Bonn	53
	8338	Bonn	53
	8339	Bonn	53
	8341	Milano	120
	8342	Milano	120
	8344	Milano	120

	8345	Milano	120
	8346	Milano	120
	8359	Manhattan	83
	8365	Solar1	166
	8366	Solar1	166
	8370	Milano	118
	8371	Milano	118
	8372	Milano	118
	8373	Milano	119
	8374	Milano	119
	8375	Milano	119
	8376	Milano	118
	8377	Madrid	126
	8379	Madrid	127
	8380	Toronto	116
	8381	Toronto	116
	8382	Toronto	116
	8385	Toronto	116
	8387	Sydney	135
	8388	Sydney	135
	8391	Toscana	117
	8392	Toscana	117
	8394	Toscana	117
	8395	Toscana	117
	8409	Roma	84
	8410	Roma	84
	8451	Nizza	114
	8452	Nizza	114
	8458	Nizza	114
	8460	Toronto	116
	8476	Madrid	126
	8480	Madrid	127
	8496	Hektor	137
	8499	Hektor	137
	8510	Manhattan	83
	8511	Roma	84
	8568	Marseille	129
	8569	Marseille	129
	8570	Marseille	128
	8617	Marseille	128
	8618	Marseille	128
	8677	Barcelona	125
	8678	Barcelona	125
	8679	Barcelona	125
	8680	Oslo	134
	8681	Oslo	133
	8682	Oslo	134
	8683	Stuttgart	105
	8684	Stuttgart	105
	8685	Stuttgart	105
	8686	Vigo	131
	8687	Vigo	131
	8714	Tacoma	148
	8716	Oslo	134
	8717	Oslo	134
	8736	Oslo	133
	8737	Oslo	133
	8739	Oslo	133
	8740	Oslo	133
	8753	Norvich	137
	8754	Norvich	137
	8763	Oslo	132
	8764	Oslo	132

CONTENTS • TARTALOMJEGYZÉK • INHALTSVERZEICHNIS

New	Art. number	Name	Page
Új	Cikkszám	Név	Oldal
Neu	Art. nummer	Name	Seite

New	Art. number	Name	Page
Új	Cikkszám	Név	Oldal
Neu	Art. nummer	Name	Seite

New	Art. number	Name	Page
Új	Cikkszám	Név	Oldal
Neu	Art. nummer	Name	Seite

New	Art. number	Name	Page
Új	Cikkszám	Név	Oldal
Neu	Art. nummer	Name	Seite

	8766	Durango	136
	8767	Durango	136
	8776	Roma	84
	8795	Birmingham	67
	8797	Austin	104
	8799	Sevilla	85
	8800	Sevilla	85
	8832	Medina	78
	8833	Medina	78
	8834	Medina	78
	8835	Medina	78
	8873	Maribor	66
	8874	Maribor	66
	8888	Budapest	51
	8889	Budapest	51
	8890	Budapest	51
	8893	Trento	149
	8894	Trento	149
	8940	Rodez	85
	8948	Mora	166
	8949	Mora	166
	71132	Lucas	107
	71133	Lucas	107
	71134	Lucas	107
	71169	Boven	148
	71170	Boven	148
	71252	Samira	100
	71253	Samira	100
	71254	Samira	100
	71255	Samira	100
	71256	Samira	100
	71257	Samira	101
	71258	Samira	101
	71259	Samira	101
	71260	Samira	101
	71261	Samira	101
new	71342	Koven	87
new	71343	Koven	87
new	71422	Alenzo	96
new	71423	Alenzo	96
new	71424	Alenzo	97
new	71425	Alenzo	94
new	71426	Alenzo	94
new	71427	Alenzo	95
new	71428	Alenzo	98
new	71429	Alenzo	95
new	71430	Alenzo	98
new	71431	Alenzo	99
new	71432	Alenzo	96
new	71433	Alenzo	96
new	71434	Alenzo	97
new	71435	Alenzo	94
new	71436	Alenzo	94
new	71437	Alenzo	95
new	71438	Alenzo	98
new	71439	Alenzo	95
new	71440	Alenzo	98
new	71441	Alenzo	99
	75009	Larcia	104
	75010	Larcia	104
	75011	Larcia	107
	75012	Larcia	107
	75025	Gaelo	103

	75026	Gaelo	103
	76007	Ishtar	140
	76010	Taena	141
	76013	Taena	141
	77001	Wigry	162
	77002	Bobus	162
	77003	Ximpu	162
	77004	Narmada	155
	77005	Qesa	154
	77006	Brezno	155
	77007	Skadar	164
	77008	Treppio	164
	77011	Kelna	147
	77012	Zlarin	161
	77013	Sepik	156
	77014	Moselle	154
	77015	Kapuas	154
	77016	Ansoo	168
	77017	Alaska	151
	77018	Alaska	151
	77019	Valpovo	161
	77020	Lihull	159
	77021	Dojran	161
	77024	Kangton	156
	77025	Ankara	38
	77026	Ankara	38
	77027	Teplice	41
	77028	Hitura	110
	77029	Hitura	110
	77030	Lutto	155
	77031	Kalisz	27
	77032	Kalisz	27
	77033	Kalisz	27
	77034	Emmen	156
	77035	Indre	93
	77036	Indre	93
	77037	Angers	153
	77038	Angers	153
	77039	Angers	153
	77040	Flaxton	158
	77041	Hulst	67
	77042	Rennes	68
	77044	Geleen	152
	77045	Geleen	152
	77046	Sluis	144
	77047	Rupit	163
	77048	Titu	163
	77049	Tilburg	60
	77050	Tilburg	60
	77051	Ognon	60
	77054	Cernon	29
	77055	Cernon	29
	77056	Cernon	29
	77057	Odiel	30
	77058	Odiel	30
	77059	Odiel	30
	77060	Odiel	30
	77061	Gendt	83
	77062	Assen	140
	77064	Senica	73
	77065	Temse	61
	77066	Temse	61
	77073	Mataro	74

	77074	Mataro	74
	77075	Mataro	74
	77076	Mataro	74
	77078	Lasset	152
	77079	Lasset	152
	77080	Loanda	40
	77081	Loanda	40
	77082	Loanda	40
	77083	Haren	45
	77084	Haren	45
	77085	Zernest	43
	77086	Zernest	43
	77087	Zernest	43
	77088	Nantes	147
	77089	Konin	141
	77090	Flaxton	158
	77091	Leszno	159
	77092	Zaragoza	69
	77093	Zaragoza	69
	77095	Andelle	68
	77096	Andelle	68
	77097	Gimone	68
	77098	Gimone	68
	77099	Lublin	82
	77100	Lublin	82
	77101	Telde	28
	77102	Telde	28
	77103	Medna	28
	77104	Medna	28
	77105	Trento	149
new	77106	Tarpa	44
new	77107	Tarpa	44
new	77108	Tarpa	44
new	77109	Ibar	67
new	77110	Enol	36
new	77111	Enol	36
new	77112	Enol	36
new	77113	Enol	36
new	77114	Mataro	67
new	77115	Zaragoza	69
new	77116	Zaragoza	69
new	77117	Batida	71
new	77118	Batida	71
new	77119	Batida	71
new	77120	Batida	71
new	77121	Laxa	73
new	77122	Ankara	38
new	77123	Biri	168
new	77124	Biri	168
new	77125	Kelebia	64
new	77126	Darvas	34
new	77127	Darvas	34
new	77128	Darvas	34
new	77129	Zavod	160
new	77130	Leitha	35
new	77131	Leitha	35
new	77132	Leitha	35
new	77133	Lowar	92
new	77134	Lowar	92
new	77135	Lowar	92
new	77136	Lowar	92
new	77137	Lowar	108
new	77138	Lowar	108

new	77139	Lowar	108
new	77140	Lowar	108
new	77141	Melk	160
new	77142	Burdur	143
new	77143	Funes	143
new	77144	Funes	143
new	77145	Funes	143
new	77146	Polperro	142
new	77147	Polperro	142
new	77148	Wengen	31
new	77149	Wengen	31
new	77150	Rapla2	73
new	77151	Rust	62
new	77152	Rust	62
new	77153	Rust	62
new	77154	Urfa	76
new	77155	Urfa	76
new	77156	Urfa	76
new	77157	Urfa	76
new	77158	Ravello	165
new	77159	Tarcal	158
new	77160	Tarcal	158
new	77161	Urfa	77
new	77162	Urfa	77
new	77163	Urfa	77
new	77164	Urfa	77
new	77165	Zirc	163
new	77167	Savoca	144
new	77168	Hallstatt	63
new	77169	Hallstatt	63
new	77170	Hallstatt	63
new	77171	Tolna	33
new	77172	Tolna	33
new	77173	Tolna	33
new	77174	Kobarid	67
new	77175	Trillo	167
new	77176	Tapolca	144
new	77177	Monor	165
	77181	Lowar	92
new	77182	Lowar	92
new	77183	Cubbington	26
new	77184	Cubbington	26
new	77185	Cubbington	26
new	77186	Cong	165
new	77187	Bokod	167
new	77188	Holne	165
	79021	Led Strip	169
	79022	Led Strip	169

IMPRINT • IMPRESSZUM • IMPRESSUM

English

Colour and pattern discrepancy are possible. We are entitled to change the pattern.
We don't bear the responsibility of the printing failure.

Magyar

Szín és minta eltérés lehetséges. A minta változtatás jogát fenntartjuk!
Az esetleges nyomdai hibákért elnézésüket kérjük és azokért felelősséget nem vállalunk.

Deutsch

Farbe und Musterunterschied ist möglich. Wir halten das Recht von Musteränderung aufrecht.
Vor die eventuellen Druckfehler bitten wir um Entschuldigung und vor die Fehler können wir die Verantwortung nicht übernehmen.

Français

Il est bien possible d'avoir quelques alternances de la coloration et du modèle. Nous soutenons notre droit aux changements de modèles.
Excusez-nous des éventuelles fautes d'imprimerie dont nous ne nous considérons pas être les responsables.

Česky

Prodejce si vyhrazuje právo průběžně modifikovat své výrobky a tedy údaje uvedené v tomto katalogu mohou být bez předchozího oznámení změněny.
Tiskové chyby vyhrazeny.

Slovensko

Obstaja možnost odstopanja pri odtenu barve izdelka. Pridržujemo si pravico do spremembe vzorca.
Ne prevzemamo odgovornosti za morebitne tiskarske napake.

Polski

Możliwe są odchylenia w kolorach i wzorach. Podtrzymujemy prawo zachowania zmiany wzoru.
Przepraszamy, a zarazem nie ponosimy odpowiedzialności za ewentualne błędy powstałe w druku.

Українська

Можлив зм ни у вз рцях та кольорах. Ми можемо зм нити вз рц на св й розсуд.
За можлив друкарськ помилки просимо вибачення та в дпов дальност не несемо.

Română

Este posibilă alternanța model/culoare. Ne reținem dreptul de a schimba modelele.
Pentru eventualele greseli de tipar, Va cerem scuze ;dar nu ne asumăm răspunderea pentru ele.

Srpski

Moguće su razlike u bojama i šarama. Zadržavamo pravo na promene šara.
Za moguće štamparske greške unapred se izvinjavamo i za njih ne primamo na sebe odgovornost.

Hrvatski

Postoji mogućnost odstupanja u nijansi boje artikla.
Ne snosimo odgovornost u slučaju pogreške u tisku.

Slovensky

Predávajúci si vyhradzuje právo priebežne modifikovať svoje výrobky a preto aj údaje uvedené v tomto katalógu,
môžu byť zmenené bez predchádzajúceho oznámenia.
Za prípadné tlačové chyby nenesieme zodpovednosť.

български

Възможни са промени в цветовете и нюансите.
Ние не носим отговорност за печатни грешки.

Lietuvių

Galimi spalvų ir rašto netikslumai. Pasiliegame teisę keisti raštą.
Atsiprašome, bet už spausdinimo klaidas neprisiimame atsakomybės.

Latviešu

Ir iespējamas krāsas un modeļa neatbilstības. Mēs paturam tiesības mainīt modeli.
Atvainojamies, tomēr neuzņemamies atbildību par drukas kļūdām.

Eesti

Värv ja muster võib erineda. Jätame endale õiguse mustri muutmiseks.
Vabandame, kuid ei vastuta trükkivigade eest.

Grafikai munkák: Visionext Reklámstúdió
Nyomdai munkák: Keskeny és Társai 2001 Kft.



www.rabalux.com