



EGLO
my light | my style



2025/26

OUTDOOR LUMINAIRES
AUSSENLEUCHTEN
LUMINAIRES EXTÉRIEURS



Dear business partners and loyal EGLO friends,

we offer the perfect lighting for your garden, terrace or balcony. Our selection of exterior lights ranges from classic models to modern, minimalist, and even extravagant designs.

Exterior luminaires are not only aesthetically appealing – they provide essential security for your home too, particularly during dark autumn evenings and winter months. The lights in our Safety & Comfort range, all of which feature motion sensors, are ideal for this purpose.

Our connect.z smart light system makes operating your lighting system easy and convenient from your mobile or by remote control. We offer a range of products that allows you to stay connected even in the garden.

We have also responded to the trends of sustainability, energy saving and the responsible use of resources in our outdoor luminaires range. Here we have solar models with high light output.

We hope you enjoy browsing our catalogue!

Geschätzte Geschäftspartner*innen, treue EGLO Freund*innen,

wir bieten Ihnen die perfekte Beleuchtung für Ihren Garten, Ihre Terrasse oder Ihren Balkon. Unser Sortiment an Außenleuchten reicht von klassischen Modellen bis hin zu modernen, minimalistischen und auch extravaganten Designs.

Außenleuchten sind aber nicht nur aus ästhetischen Gründen sinnvoll, sondern sorgen vor allem in den dunklen Herbsttagen und Wintermonaten für die nötige Sicherheit rund um Ihr Zuhause. Das gelingt mit unseren Leuchten aus dem Bereich Safety & Comfort, welche alle über Bewegungssensoren verfügen.

Unser Smart Light System connect.z ermöglicht Ihnen die bequeme Bedienung Ihres Lichtsystems. Von Ihrem Mobiltelefon aus oder per Fernbedienung. Hier bieten wir eine Produktrange, die Konnektivität bis in den Garten bietet.

Auf die Trends Nachhaltigkeit, Energiesparen und dem verantwortungsvollen Umgang mit Ressourcen, haben wir auch in unserem Außenleuchten Sortiment reagiert. Hier haben wir Solarmodelle mit hoher Lichtleistung in unserem Sortiment.

Wir wünschen Ihnen viel Vergnügen beim Durchstöbern unseres Katalogs!

Chers partenaires commerciaux*, fidèles amis d'EGLO*,

nous vous proposons l'éclairage parfait pour votre jardin, votre terrasse ou votre balcon. Notre gamme d'éclairage extérieur va des modèles classiques aux designs modernes, minimalistes et même extravagants.

Les éclairages extérieurs ne sont pas seulement utiles pour des raisons esthétiques, ils assurent également la sécurité nécessaire autour de votre maison, surtout pendant les sombres journées d'automne et les mois d'hiver. C'est possible grâce à nos luminaires de la gamme Safety & Comfort, qui disposent tous de capteurs de mouvement.

Notre système d'éclairage intelligent connect.z vous permet de commander facilement votre système d'éclairage. Depuis votre téléphone portable ou par télécommande. Nous proposons ici une gamme de produits qui offre une connectivité jusque dans le jardin.









Nous avons également réagi aux tendances de la durabilité, des économies d'énergie et de l'utilisation responsable des ressources dans notre gamme de luminaires d'extérieur. Notre assortiment comprend des modèles solaires à forte intensité lumineuse.

Nous vous souhaitons beaucoup de plaisir à parcourir notre catalogue !



CONTENT

INHALT
CONTENU

- | | | |
|------------|--|---|
| 4 |  A blue square icon with a white water droplet and the text 'HIGH IP' below it. | High IP Class
Hohe IP Klasse
Classe IP élevée |
| 8 |  A yellow square icon with a white shield containing a house silhouette. | Safety & Comfort
Sicherheit und Komfort
Sécurité & confort |
| 14 |  A green square icon with a white Wi-Fi signal symbol. | EGLO connect.z
EGLO connect.z
EGLO connect.z |
| 36 |  A magenta square icon with a white stylized pen nib. | Modern
Modern
Moderne |
| 80 |  A dark blue square icon with a white open book silhouette. | Timeless
Zeitlos
Intemporel |
| 146 |  A green square icon with a white lantern silhouette. | Traditional
Traditionell
Traditionnel |
| 178 |  A brown square icon with a white silhouette of a person walking and a Wi-Fi signal symbol. | Functional
Funktionell
Fonctionnel |
| 206 |  A red square icon with a white sun and a lightning bolt. | Solar
Solar
Solaire |
| 230 |  A dark grey square icon with a white circle containing an 'i'. | Legend & Register
Legende und Register
Légende & registre |

Best protection against wind and weather

Bester Schutz vor Wind und Wetter
Meilleure protection contre le vent et les intempéries



EGLO's High IP class product range includes all luminaires with a particularly high degree of protection. These are best suited for harsh environments such as sandy or coastal regions.

All EGLO outdoor lights are basically secured with at least a degree of protection of IP44! For higher degrees, the degree of protection is indicated in the info box of the lights.

EGLOs High IP class Produktsortiment umfasst alle Leuchten mit einem besonders hohen Schutzgrad. Diese sind bestens geeignet für raue Umgebungen wie beispielsweise sandige oder küstennahe Regionen.

Alle EGLO Außenleuchten sind grundsätzlich mit mindestens einem Schutzgrad von IP44 gesichert! Bei höheren Graden wird der Schutzgrad im Infokasten der Leuchten angegeben.

La gamme de produits EGLO de classe IP élevée comprend tous les luminaires présentant un degré de protection particulièrement élevé. Ils sont parfaitement adaptés aux environnements difficiles tels que les régions sablonneuses ou côtières.

Toutes les lampes d'extérieur EGLO sont toujours protégées avec un degré de protection d'au moins IP44 ! Pour les degrés supérieurs, le degré de protection est indiqué dans la boîte d'information des feux.

SOLIDS / FESTSTOFFE / SOLIDES

0	Non protected. Nicht geschützt. Non protégé.
1	Protected against a solid object greater than 50mm, such as a hand. Geschützt gegen feste Gegenstände, die größer als 50 mm sind, wie z. B. eine Hand. Protégé contre un objet solide de plus de 50 mm, comme une main.
2	Protected against a solid object greater than 12mm, such as a finger. Geschützt gegen feste Gegenstände, die größer als 12 mm sind, wie z. B. einen Finger. Protégé contre un objet solide de plus de 12 mm, tel qu'un doigt.
3	Protected against a solid object greater than 2,5mm, such as a screw driver. Geschützt gegen feste Gegenstände, die größer als 2,5 mm sind, z. B. einen Schraubendreher. Protégé contre un objet solide supérieur à 2,5 mm, tel qu'un tournevis.
4	Protected against a solid object greater than 1mm, such as a screw or wire. Geschützt gegen feste Gegenstände, die größer als 1 mm sind, wie z. B. Schrauben oder Drähte. Protégé contre un objet solide de plus de 1 mm, tel qu'une vis ou un fil.
5	Dust protected. Prevents ingress of dust sufficient to cause harm. Staubgeschützt. Verhindert das Eindringen von Staub, der ausreicht, um Schäden zu verursachen. Protégé contre la poussière. Empêche la pénétration de poussière suffisamment pour causer des dommages.
6	Dust tight. No ingress of dust. Staubdicht. Kein Eindringen von Staub. Étanche à la poussière. Pas de pénétration de poussière.

WATER / WASSER / L'EAU

0	Non protected. Nicht geschützt. Non protégé.
1	Protected against vertical dripping water. Limited liquid entry. Geschützt gegen senkrechtes Tropfwasser. Eingeschränkter Flüssigkeitseintrag. Protégé contre les gouttes d'eau verticales. Entrée de liquide limitée.
2	Protected against vertical dripping water when tiled up 15°. Limited liquid entry. Geschützt gegen senkrechtes Tropfwasser bei Verfliesung 15°. Eingeschränkter Flüssigkeitseintrag. Protégé contre les gouttes d'eau verticales lorsqu'il est carrelé jusqu'à 15°. Entrée de liquide limitée.
3	Protected against vertical spraying water at an angle up to 68°. Limited liquid entry. Geschützt gegen senkrechtes Spritzwasser in einem Winkel bis 68°. Eingeschränkter Flüssigkeitseintrag. Protégé contre les projections d'eau verticales à un angle allant jusqu'à 68°. Entrée de liquide limitée.
4	Protected against vertical splashing water at an angle up to 60°. Limited liquid entry. Geschützt gegen senkrechtes Spritzwasser in einem Winkel bis 60°. Eingeschränkter Flüssigkeitseintrag. Protégé contre les projections d'eau verticales à un angle allant jusqu'à 60°. Entrée de liquide limitée.
5	Protected against jets of water from all directions. Limited liquid entry. Geschützt gegen Strahlwasser aus allen Richtungen. Eingeschränkter Flüssigkeitseintrag. Protégé contre les jets d'eau de toutes directions. Entrée de liquide limitée.
6	Protected against powerful jets of water from all directions. Limited liquid entry. Geschützt gegen starke Wasserstrahlen aus allen Richtungen. Eingeschränkter Flüssigkeitseintrag. Protégé contre les jets d'eau puissants de toutes les directions. Entrée de liquide limitée.
7	Protected against the effects of water immersion between 15cm and 1m. Geschützt gegen die Auswirkungen von Wassereintauchen zwischen 15 cm und 1 m. Protégé contre les effets d'une immersion dans l'eau entre 15cm et 1m.
8	Protected against the effects of water immersion under pressure beyond 1m. Geschützt gegen die Auswirkungen des Eintauchens in Wasser unter Druck über 1 m. Protégé contre les effets de l'immersion dans l'eau sous pression au-delà de 1m.

IP65

For more detailed information see DIN EN 60529.
Für genauere Informationen siehe DIN EN 60529.
Pour des informations plus détaillées, voir DIN EN 60529.

HIGH IP CLASS

Chapter / Kapitel / Chapitre **connect.z**



Chapter / Kapitel / Chapitre **Modern**



Chapter / Kapitel / Chapitre **Timeless**





MARGIDORE

131

MINERARIO

132-135

CASTAGNETO

136-137

MONTEROLO

144

Chapter / Kapitel / Chapitre Traditional



CANOVE

159

Chapter / Kapitel / Chapitre Functional



NEMA

180



FAEDO 4

181



FAEDO 3

184-185, 188-189



LAMEDO

194



RIGA 3

194



ZIMBA-LED

197



MARGO

197



CONNECTOR BOX

201



PARK 5

202



PARK 5

202

Chapter / Kapitel / Chapitre Solar



VOSCARI

217



DARFANO

217



LAMOZZO

220



This product is available in different colors and shapes. / Dieser Artikel ist in unterschiedlichen Farben und Formen verfügbar. / Cet article est disponible en différentes couleurs et formes.

SAFETY & COMFORT

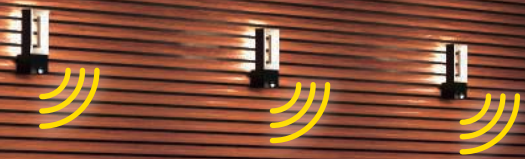



SAFETY & COMFORT



Light at the right time

Light activated by movements offers many advantages. EGLO sensor luminaires and sensors provide you with a great deal of comfort in your daily life and increase the safety of your own four walls.

Licht zum richtigen Zeitpunkt

Licht, das durch Bewegungen aktiviert wird, bietet Ihnen viele Vorteile. Mit den Sensorleuchten und Sensoren von EGLO bringen Sie erheblichen Komfort in Ihren Alltag und erhöhen die Sicherheit rund um Ihr Zuhause.

Lumière au bon moment

Lumière, qui est activé par le mouvement, offre de nombreux avantages. Avec les lumières des capteurs et des capteurs de EGLO apporter un confort considérable dans votre vie quotidienne et d'augmenter la sécurité de vos propres quatre murs.



1. COMFORT



2. SAFETY



3. SECURITY



4. SAVE MONEY

1. COMFORT

The light comes on – without requiring you to push a button, leaving your hands free to carry your shopping bags. Come home comfortably with the sensors and sensor lamps by EGLO.

2. SAFETY

EGLO sensors and sensor lamps will show you thresholds and tripping hazards in time. Lower your accident risk in and around your home.

3. SECURITY

Motion detection will safely light up badly visible areas when this is necessary. You will always be able to see what is happening and can deter unbidden guests with the EGLO sensors and sensor lamps.

4. SAVE MONEY

Sensors and sensor lamps by EGLO help you save money. Your light will only come on when it is needed, and lower the energy costs for every home.

1. KOMFORT

Das Licht geht an – ohne dass Sie einen Schalter drücken müssen und Sie haben die Hände frei, um die Einkäufe zu tragen. Kommen Sie komfortabel nach Hause mit den Sensoren und Sensorleuchten von EGLO.

2. SICHERHEIT

EGLO Sensoren und Sensorleuchten lassen Sie Schwellen und Stolperfallen vorzeitig erkennen. Senken Sie dadurch das Unfallrisiko in und um Ihr Zuhause.

3. SCHUTZ

Durch die Erfassung von Bewegung können schlecht einsichtbare Bereiche beleuchtet werden, wenn es notwendig ist. Sehen Sie immer was passiert und schrecken Sie ungebetene Gäste mit EGLO Sensoren und Sensorleuchten ab.

4. GELD SPAREN

Sensoren und Sensorleuchten von EGLO helfen Ihnen bares Geld zu sparen. Das Licht geht nur an, wenn es benötigt wird und senkt damit die Energiekosten in Ihrem Zuhause.

1. COMFORT

La lumière s’allume – sans que vous n’ayez besoin de presser un interrupteur et vous avez les mains libres pour porter les achats. Entrez confortablement chez vous avec les capteurs et les luminaires à capteurs d’EGLO.

2. SÛRETÉ

Les capteurs et les luminaires à capteurs d’EGLO vous permettent de détecter d’avance les seuils et sources de trébuchement. Réduisez ainsi les risques d’accident dans et autour de votre foyer.

3. SÉCURITÉ

Il est possible grâce à la saisie des mouvements d’éclairer au besoin des zones difficiles à voir. Ayez toujours un œil sur ce qu’il se passe et découragez les intrus avec les capteurs et les lampes à capteur d’EGLO.

4. DE L’ARGENT EN SÉCURITÉ

Les capteurs et les lampes à capteur d’EGLO vous aident à économiser de l’argent comptant. La lumière ne vient que lorsque celle-ci est requise, ce qui réduit ainsi les dépenses énergétiques de tout foyer.

SAFETY & COMFORT

Chapter / Kapitel / Chapitre **connect.z**



CONNECT-Z SENSOR

24

Chapter / Kapitel / Chapitre **Modern**



RIFORANO

41



FIUMICINO

50



PALOSCO

52



CALDIERO

52



FORNACI

55



BELCREDA

70



SESIMBA 1

73

Chapter / Kapitel / Chapitre **Timeless**



ALAMONTE 3

84



ALAMONTE

86



HELSINKI

95-97



RIGA 5

102-103



ATOLLARI

103



SAKEDA

118



BREGANZO 1

123



TRIBANO

123



CERNO

125



CITY

126-127



CORNALE

138



MADRIZ

140



AZZINANO

141



MUSSOTTO

141



VERRES

141

Chapter / Kapitel / Chapitre Traditional



SIDNEY

151



LISIO

152



NAVEDO

164, 169



LATERNA 4

171



LATERNA 5

174

Chapter / Kapitel / Chapitre Functional



PAGINO

182



FAEDO 3

186-187, 190-191



DETECT ME 3

192-193



DETECT ME 1

192-193



DETECT ME 6

192-193



LM_LED_E27

198

Chapter / Kapitel / Chapitre Solar



DREOLI

210



CERRISI

210



ALTLIA

212



PANTETE

215



SPIANTE

216



BARACCONI

216



VOSCARI

217



DARFANO

217



UTRERA

218



CROARA

218



PASTION

218



CORBEZZOLA

219



MARTANO

219



SUZZARA

219



STIAPPA

220



LAMOZZO

220



PORRASSA

221



PANETTIERI

222



CASABAS

223



This product is available in different colors and shapes. / Dieser Artikel ist in unterschiedlichen Farben und Formen verfügbar. / Cet article est disponible en différentes couleurs et formes.

connect.z

 zigbee  Bluetooth®

DISCOVER THE SMART WORLD



LIGHT UP YOUR WORLD!

Bringen Sie Licht in Ihren Alltag!

Illuminez votre quotidien !

Choose the perfect mood for your home from thousands of colors.
Wählen Sie aus tausenden von Farben die perfekte Stimmung für Ihr zuhause.
Choisissez parmi des milliers de couleurs l'ambiance parfaite pour votre maison.



Tunable White

Individual light from
50,000 white tones.
Individuelles Licht aus
50.000 Weißtönen.
Luminaire individuel à
50 000 tons de blanc.



Tunable White + RGB Colours

Diverse lighting selection from 50,000 white tones and 16 million colours.
Vielseitige Lichtauswahl aus 50.000 Weißtönen und 16 Mio. Farben.
Sélection étendue de luminaires à 50 000 tons de blanc et 16 millions de couleurs.



START QUICKLY AND EASILY WITH A REMOTE CONTROL CONNECTION

Starten Sie schnell und einfach mit einer Fernbedienungsverbindung
Démarez rapidement et facilement avec votre télécommande

You want to start with a remote control? No problem, of course all our smart lights can also be controlled without an app.

Sie wollen vorerst nur eine Fernbedienung verwenden? Kein Problem, natürlich sind all unsere smarten Leuchten auch ohne App steuerbar.

Vous ne voulez utiliser qu'une seule télécommande pour le moment ? Pas de problème, tous nos luminaires intelligents peuvent bien sûr être contrôlés sans application.



connect.z **remote**



With the **connect.z remote**, our smart lights can be connected directly without an app or hub. **Create up to 3 groups** with the group buttons and connect **up to 50 luminaires with one remote control**.

Mit der **connect.z remote** lassen sich unsere smarten Leuchten direkt und ohne App oder Hub verbinden. **Erstellen Sie bis zu 3 Gruppen** mit den Gruppentasten und verbinden Sie **bis zu 50 Leuchten mit einer Fernbedienung**.

La télécommande **connect.z remote** permet de connecter directement nos luminaires intelligents, sans application ni hub. **Créez jusqu'à 3 groupes** avec les boutons de groupe et connectez **jusqu'à 50 luminaires avec une seule télécommande**.



connect.z **switch**



With its **three buttons**, it not only enables luminaires to be switched **on and off**, but also **dimming** and changing the **light colour**. A **favourite setting** can also be saved on the switch.

Mit seinen **drei Tasten** ermöglicht er nicht nur das **Ein- und Ausschalten** von Leuchten, sondern auch das **Dimmen** und Ändern der **Lichtfarbe**. Zusätzlich ist am Switch eine **Favoriten-Einstellung** speicherbar.

Avec ses **trois touches**, il permet non seulement **d'allumer et d'éteindre** les luminaires, mais aussi de faire varier l'intensité **et la couleur** de **la lumière**. De plus, il est possible de **mémoriser un réglage favori** sur le commutateur.

WORKS WITH BLUETOOTH APP CONNECTION

Funktioniert mit Bluetooth-App Verbindung
L'application fonctionne avec une connexion Bluetooth

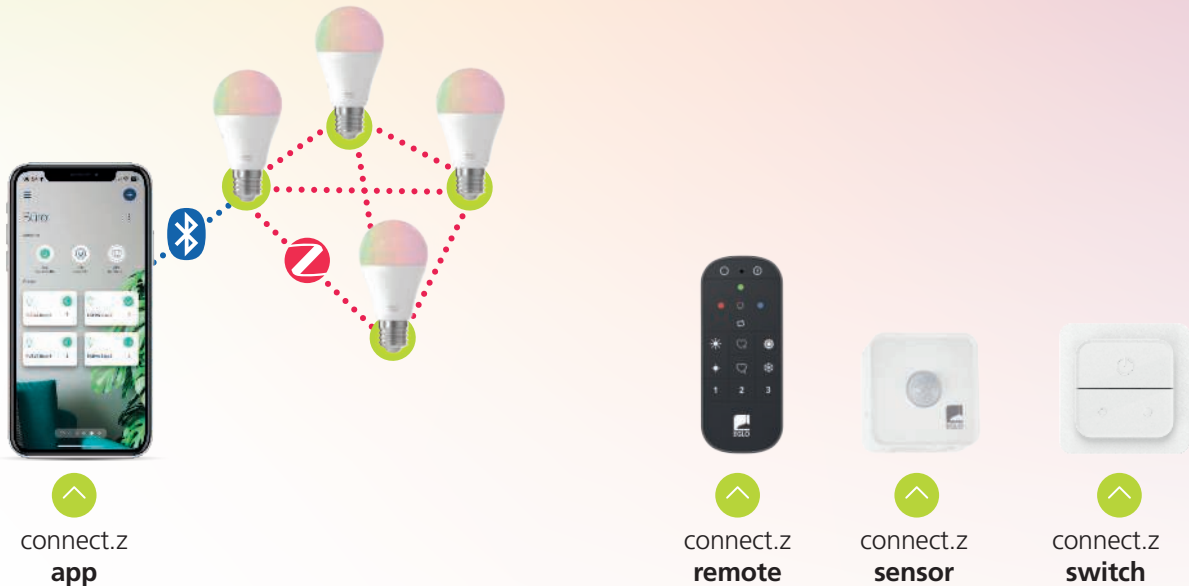

Connect our luminaires **directly with Bluetooth and our app - no hub is required.** The luminaires build a stable Zigbee network with each other, so up to 50 luminaires can be controlled using just a smartphone.

Verbinden Sie unsere Leuchten **direkt mit Bluetooth und unserer App - es ist kein Hub notwendig.** Die Leuchten bauen untereinander ein stabiles Zigbee Netzwerk auf, so können auch bis zu 50 Leuchten nur über das Smartphone gesteuert werden.

Connectez nos luminaires **directement avec Bluetooth et notre application - aucun hub n'est nécessaire.** Les luminaires établissent entre eux un réseau Zigbee stable, ce qui permet de contrôler jusqu'à 50 luminaires uniquement via le smartphone.

Also add **our smart accessories** (remote, sensor and switch) to the app for even more flexible control of your luminaires.

Fügen Sie auch **unsere smarten Accessories** (Remote, Sensor und Switch) in der APP hinzu, um eine noch flexiblere Steuerung Ihrer Leuchten zu ermöglichen.

Ajoute **également nos accessoires intelligents** (Remote, Sensor et Switch) dans l'APP pour un contrôle encore plus flexible de tes luminaires.



You already own connect-c luminaires from the previous system? What now? No problem! The previous connect-c products can be controlled together with the connect.z products via our app.

Sie besitzen bereits connect-c Leuchten des Vorgängersystems? Was nun? Kein Problem! Die bisherigen connect-c Produkte können zusammen mit den connect.z Produkten über unsere App gesteuert werden.

Vous possédez déjà des luminaires connect-c de l'ancien système ? Et maintenant ? Pas de problème ! Les produits connect-c précédents peuvent être contrôlés avec les produits connect.z via notre application.

MAKE MORE OF YOUR LIGHT: DISCOVER OUR APP

Machen Sie mehr aus Ihrem Licht: Entdecken Sie unsere App
Tirez le meilleur parti de votre lumière : découvrez notre application

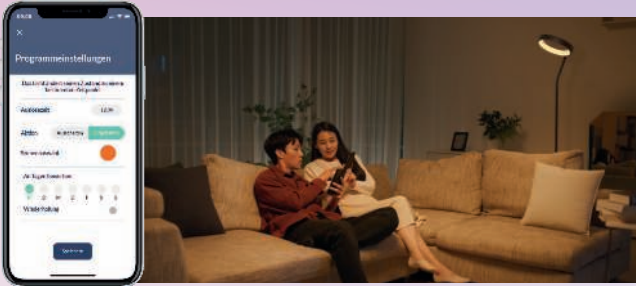

TIMERS AND CALENDARS TIMER UND KALENDER MINUTERIE ET CALENDRIER

Make your daily life easier with timers and calendars. Develop your own lighting routines and make your life easier.

Unterstützen Sie Ihren Alltag mit Timern und Kalendern. Entwickeln Sie eigene Lichtroutinen und machen Sie Ihr Leben leichter.

Facilitez-vous la vie à l'aide de la fonction minuterie et calendrier. Développez vos propres routines d'éclairage et facilitez votre vie.

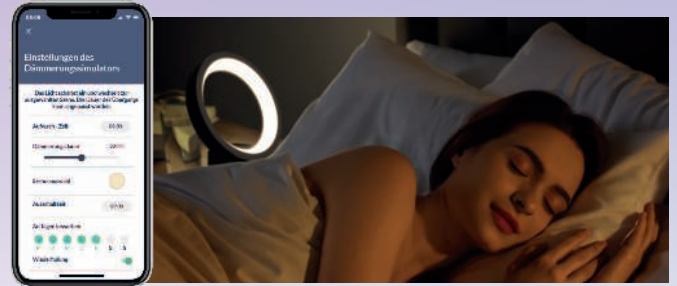

LIGHT ALARM CLOCK LICHTWECKER REVEIL LUMINEUX

You'd rather not start your day in a bad mood? Wake up relaxed with the simulated sunrise.

Keine Lust mit schlechter Laune in den Tag zu starten? Entspannt aufwachen mit dem simulierten Sonnenaufgang.

Pas envie de commencer la journée de mauvaise humeur ? Réveillez-vous en douceur grâce au simulateur de lever de soleil.



DISCO FUNCTION/MODE DISCOFUNKTION/MODUS FONCTION/MODE DISCO

For the perfect party mood, the disco function synchronises the light to the beat of your favourite songs.

Für die perfekte Partystimmung schaltet die Discofunktion das Licht passend zum Beat Ihres Lieblingssongs.

Pour une ambiance festive parfaite, la fonction disco enclenche le luminaire au rythme de votre chanson préférée.



PRESENCE SIMULATOR ANWESENHEITSSIMULATION SIMULATEUR DE PRESENCE

Protect your home with the convenient presence simulator. Variable time intervals allow the system to turn the luminaires on and off to simulate your presence at home and deter unwanted guests.

Schützen Sie Ihr Zuhause mit der komfortablen Anwesenheitssimulation. Dank variabler Zeitintervalle simuliert das System durch Ein- und Ausschalten der Beleuchtung die Anwesenheit im Haus und schreckt so ungebetene Gäste ab.

Protégez votre domicile à l'aide du très pratique simulateur de présence. Le système simule votre présence en allumant et en éteignant les lumières à intervalles variables et décourage ainsi les invités indésirables.

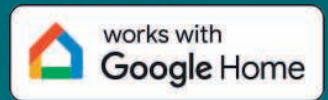

WORKS WITH GOOGLE HOME

Funktioniert mit Google Home
Funtionne avec Google Home

You can connect up to 6 of our connect.z luminaires directly to your Google Home smart speaker via Bluetooth.
Sie können bis zu 6 unserer connect.z Leuchten direkt mit Bluetooth mit Ihrem Google Home Smart Speaker verbinden.
Tu peux connecter jusqu'à 6 de nos luminaires connect.z directement par Bluetooth à ton Google Home Smart Speaker.

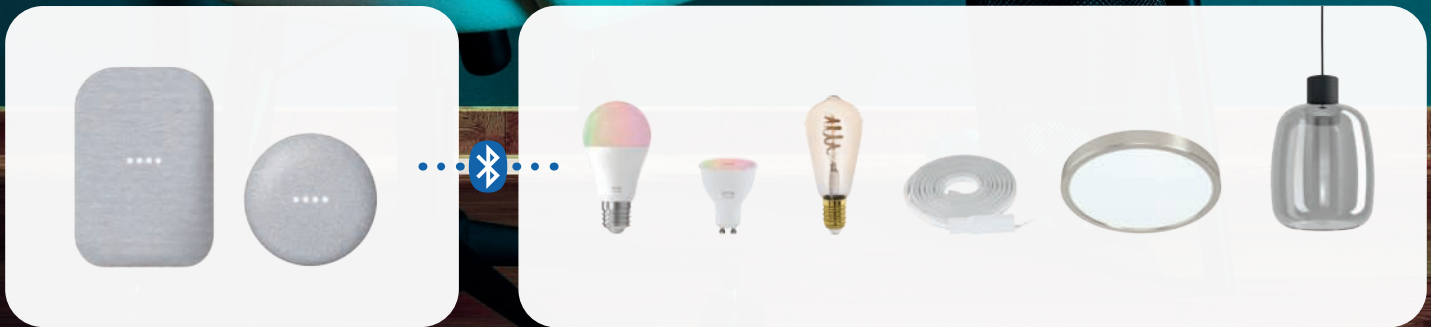



WORKS WITH ALEXA

Funktioniert mit Alexa
Fonctionne avec Alexa

Enjoy the comfort of creating your ideal living room lighting ambience with just one voice command.
Genießen Sie den Komfort, Ihr ideales Beleuchtungsambiente im Wohnzimmer mit nur einem Sprachbefehl zu gestalten.
Profitez du confort de créer votre ambiance d'éclairage idéale dans le salon avec une seule commande vocale.

with **integrated** Zigbee Hub
mit **integriertem** Zigbee Hub
avec Hub Zigbee **intégré**



Your Alexa has an **integrated Zigbee hub**? Perfect! You can connect our luminaires directly to Alexa.

Ihre Alexa hat einen **integrierten Zigbee Hub**? Optimal! Sie können unsere Leuchten direkt mit Alexa verbinden.

Votre Alexa a **un Hub Zigbee intégré**? C'est optimal! Vous pouvez connecter nos luminaires directement à Alexa.

 **zigbee**

with **separate** Zigbee Hub
mit **separatem** Zigbee Hub
avec Hub Zigbee **séparé**



Your Alexa **doesn't have an integrated Zigbee hub**? Don't worry! You can simply link an external Zigbee hub from another brand to your Alexa and then connect our luminaires to it.

Ihre Alexa **hat keinen integrierter Zigbee Hub**? Keine Sorge! Sie können einfach einen externen Zigbee Hub eines anderen Herstellers mit Ihrer Alexa verknüpfen und dann unsere Leuchten damit verbinden.

Votre Alexa **n'a pas de Hub Zigbee intégré**? Ne vous inquiétez pas! Vous pouvez simplement relier un hub Zigbee externe d'un autre fabricant à votre Alexa et y connecter ensuite nos luminaires.

Amazon Alexa and all related marks are trademarks of Amazon.com, Inc. or its affiliates.

 **zigbee**

WORKS WITH ZIGBEE

Funktioniert mit Zigbee

Fonctionne avec Zigbee



SMART HOME INTEGRATION

EINBINDUNG SMART HOME

INTÉGRATION DE LA MAISON INTELLIGENTE

You already have an existing Zigbee hub or a smart home system based on Zigbee? Perfect! Our luminaires can be integrated into any open Zigbee 3.0 system.

Sie haben bereits einen bestehenden Zigbee Hub bzw. ein Smarthome System welches auf Zigbee aufbaut? Optimal! Unsere Leuchten können in jedes offene Zigbee 3.0 System integriert werden.

Vous avez déjà un Hub Zigbee ou un système smarthome basé sur Zigbee ? C'est optimal ! Nos luminaires peuvent être intégrés dans n'importe quel système Zigbee 3.0 ouvert.

TALKS WITH HOMEY

KOMMUNIZIERT MIT HOMEY

COMMUNICATES WITH HOMEY

Do you want more than just control your lighting? Do you want to fully automate your home and have your EGLO luminaires interact in a network with a large number of intelligent devices from a wide range of manufacturers and different wireless standards? With Homey, this becomes a reality.

Sie streben nach mehr als der Kontrolle über Ihre Beleuchtung? Sie haben den Wunsch, Ihr Zuhause vollständig zu automatisieren und Ihre EGLO Leuchten in einem Netzwerk mit einer Vielzahl von intelligenten Geräten unterschiedlichster Hersteller und verschiedensten Funkstandards interagieren zu lassen? Mit Homey wird genau das zur Realität.

Tu aspiras à plus que le contrôle de ton éclairage ? Tu as envie d'automatiser entièrement ta maison et de faire interagir tes luminaires EGLO dans un réseau avec une multitude d'appareils intelligents de différents fabricants et avec les normes radio les plus diverses ? Avec Homey, c'est exactement ce qui devient réalité.

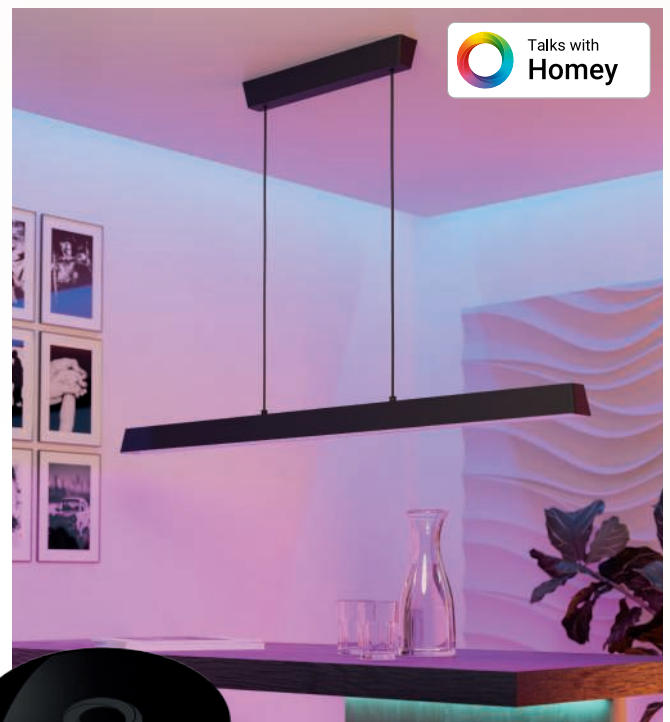



OVERVIEW

EGLO CONNECT.Z
EGLO CONNECT.Z
EGLO CONNECT.Z



Smart home made easy: Discover our entire **range of smart luminaires** in our luminaires catalogue now.

Smart Home leicht gemacht: Entdecken Sie jetzt unser gesamtes **smartes Leuchtmittel Sortiment** in unserem Leuchtmittelkatalog.

Le contrôle intelligent en toute simplicité : découvrez dès maintenant **l'ensemble de notre gamme d'ampoules intelligentes** dans notre catalogue d'ampoules.



This product is available in different colors and shapes. / Dieser Artikel ist in unterschiedlichen Farben und Formen verfügbar. / Cet article est disponible en différentes couleurs et formes.

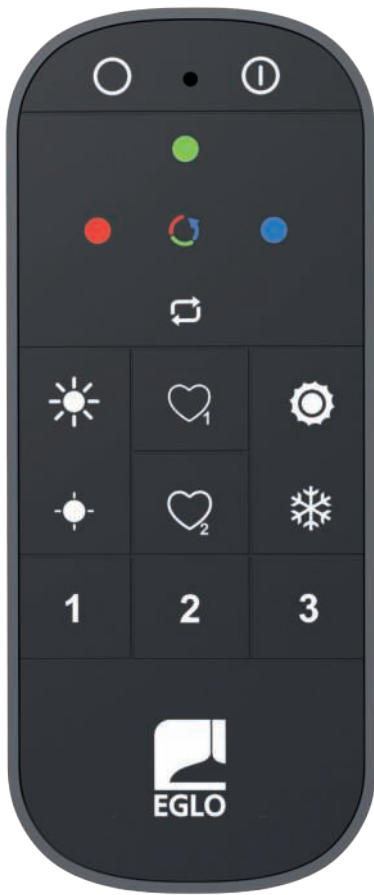

99099



99106



120°, 12 m
20 sec. - 10 min.

**SAFETY &
COMFORT**

99099 CONNECT Z REMOTE

remote control; plastic, grey
Fernbedienung; Kunststoff, grau
Télécommande; plastique, gris

L 122, B 54, H 18

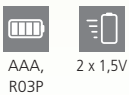

AAA, R03P
2 x 1,5V



9 002759 990992



99106 CONNECT-Z SENSOR

accessory; plastic, white
Zubehör; Kunststoff, weiss
Accessoires; plastique, blanc

L 75, H 75, A 70

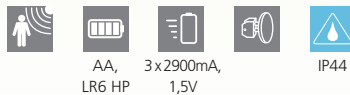

AA, LR6 HP
3x2900mA,
1,5V



IP44



9 002759 991067



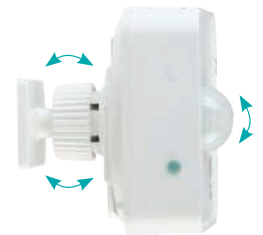

*Mounting example /
*Montage Beispiel /
*Exemple de montage

ADVANTAGES OF THE CONNECT-Z SENSOR

IP44 Safety no cabling necessary

The CONNECT-Z SENSOR is battery-operated, so that no difficult cabling is necessary. The sensor can be mounted directly on the wall. With the mounting* bracket (included in the delivery), you can easily adjust the detection range to your needs. This permits fine adjustment by 30 degrees to the left and right.

Night mode

Night mode When Night mode is enabled the luminaires receive the indication night or day from the CONNECT-Z SENSOR. Choose from 3 sensitivity settings (25 to 75%).

Night movement detection

When Night movement detection is enabled the CONNECT-Z SENSOR turns on the luminaires with the chosen light intensity when movement is detected. You can choose from 3 movement detection sensitivity settings. The light will turn off after the selected time when no movement is detected.

Combination of Night mode and Night movement detection

VORTEILE DES CONNECT-Z SENSOR

IP44 Schutz Keine Verkabelung notwendig

Der CONNECT-Z SENSOR ist batteriebetrieben, so dass keine schwierige Verkabelung erforderlich ist. Der Sensor kann direkt an die Wand montiert werden. Mit der Montagehalterung* (im Lieferumfang enthalten) können Sie den Erfassungsbereich ganz einfach an Ihre Bedürfnisse anpassen. Dadurch ist eine Feinjustierung von 30 Grad nach links und rechts möglich.

Nachtmodus

Wenn der Nachtmodus aktiviert ist, erhalten die Leuchten die Anzeige Nacht oder Tag vom CONNECT-Z SENSOR. Wählen Sie aus 3 Empfindlichkeitseinstellungen (25 bis 75%).

Nachtbewegungserkennung

Wenn die Nachtbewegungserkennung aktiviert ist, schaltet der CONNECT-Z SENSOR die Leuchten mit der gewählten Lichtintensität ein, wenn die Bewegung erkannt wird. Sie können aus 3 Bewegungserkennungseinstellungen wählen. Das Licht schaltet sich nach der gewählten Zeit aus, wenn keine Bewegung erkannt wird.

Kombination von Night mode und Night movement detection

ADVANTAGES DE LA CAPTEUR CONNECT-Z SENSOR

Protection IP44 Aucun câble nécessaire

Le CONNECT-Z SENSOR est alimenté par batterie, donc aucun câblage difficile n'est nécessaire. Avec le support de montage* (inclus dans la livraison), vous pouvez facilement ajuster l'étendue de la détection à vos besoins. Ce réglage fin de 30 degrés à gauche et à droite est possible.

Mode de nuit (Night mode)

Lorsque le mode de nuit est activé, les luminaires reçoivent l'indication du jour ou de la nuit du capteur CONNECT-Z SENSOR. Choisissez parmi 3 réglages de sensibilité (de 25 à 75%).

Détection de mouvement nocturne

Lorsque la détection de mouvement nocturne est activée, le CONNECT-Z SENSOR allume les luminaires avec l'intensité lumineuse choisie lorsqu'un mouvement est détecté. Vous pouvez choisir parmi 3 réglages de sensibilité de détection de mouvement. Si aucun mouvement n'est détecté, la lumière s'éteindra après la période sélectionnée.

Combinaison du mode de nuit et de la détection de mouvement nocturne



900124



900126



900124 ARGOLIS-Z

surface-mounted light; aluminium, black / plastic, white
 Aufbauleuchte; Alu, schwarz / Kunststoff, weiss
 luminaire en saillie; aluminium, noir / plastique, blanc

L 285, B 285, H 30

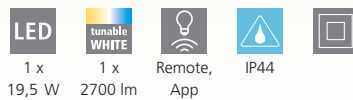

900126 ARGOLIS-Z

surface-mounted light; aluminium, black / plastic, white
 Aufbauleuchte; Alu, schwarz / Kunststoff, weiss
 luminaire en saillie; aluminium, noir / plastique, blanc

H 30, Ø 285

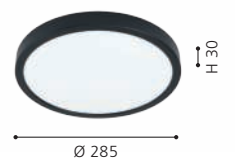
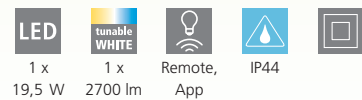



900131



901956



901955



900131 EREMITANA-Z

wall light; zinc-plated steel, black
Wandleuchte; Stahl verzinkt, schwarz
Applique; acier galvanisé, noir

L 110, H 240, A 110



9 008606 230204



901955 SANIA-Z

wall light; aluminium, steel, white / plastic, white
Wandleuchte; Alu, Stahl, weiss / Kunststoff, weiss
Applique; aluminium, acier, blanc / plastique, blanc

L 200, H 80, A 90

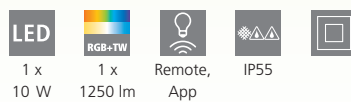

9 008606 361663

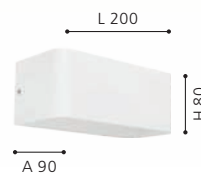

901956 SANIA-Z

wall light; aluminium, steel, black / plastic, white
Wandleuchte; Alu, Stahl, schwarz / Kunststoff, weiss
Applique; aluminium, acier, noir / plastique, blanc

L 200, H 80, A 90

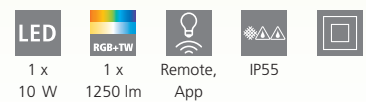

9 008606 361670

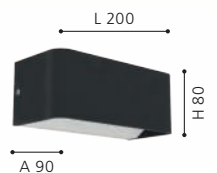



900268



900269



900271



MONTEROLO-Z

The EGLO bulb 12253 is included in the delivery.

Das EGLO Leuchtmittel 12253 ist im Lieferumfang enthalten.

L'ampoule EGLO 12253 est incluse dans la livraison.



900268 MONTEROLO-Z

floor light; plastic, white / plastic, white
Stehleuchte; Kunststoff, weiss / Kunststoff, weiss
lampadaire; plastique, blanc / plastique, blanc

900269 MONTEROLO-Z

floor light; plastic, white / plastic, white
Stehleuchte; Kunststoff, weiss / Kunststoff, weiss
lampadaire; plastique, blanc / plastique, blanc

900271 MONTEROLO-Z

floor light; plastic, white / plastic, white
Stehleuchte; Kunststoff, weiss / Kunststoff, weiss
lampadaire; plastique, blanc / plastique, blanc

H 300, Ø 300

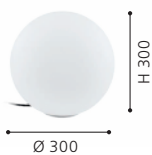
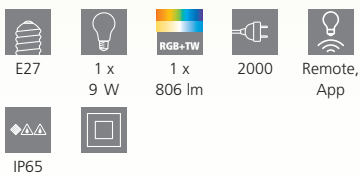

H 390, Ø 390

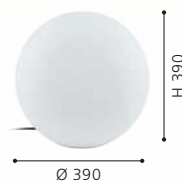
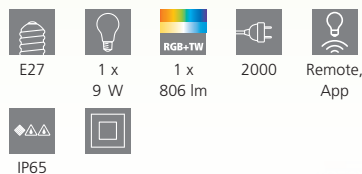

H 500, Ø 500

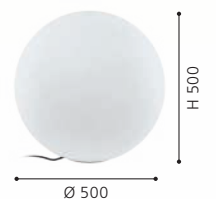
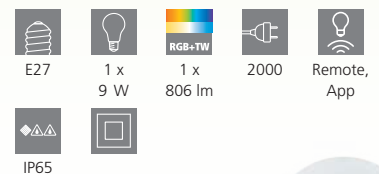



900258



900258 BASALGO-Z

pedestal light; stainless steel, black / plastic, white
 Sockelleuchte; Edelstahl, schwarz / Kunststoff, weiss
 luminaire pour socle; acier inoxydable, noir / plastique, blanc

H 450, Ø 105



E27



1 x
9 W



1 x
806 lm



Remote,
App



IP44



9 008606 231515





901092

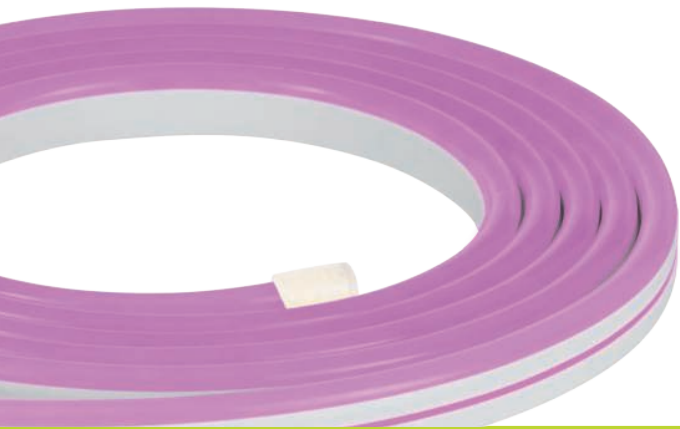

901092 FLATNEON Z

bar/strip light; plastic, white
 Leuchtband/-stab; Kunststoff, weiss
 bande lumineuse / bâton l; plastique, blanc

L 5000, B 18, H 8



1 x
24W



1 x
3200lm



Remote,
App



IP44



9 008606 297801



901095 FLATNEON Z

bar/strip light; plastic, white
 Leuchtband/-stab; Kunststoff, weiss
 bande lumineuse / bâton l; plastique, blanc

L 3000, B 18, H 8



1 x
21W



1 x
2000lm



Remote,
App



IP44



9 008606 297795

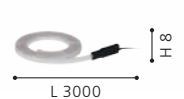



901095

LED

12253 E27-LED-A60



806 lm	RGB+TW	2700-6500 K	A ↑ G F
L 118, Ø 60	dimmable via remote & app		
9 W	15000 h		
220-240V, 50/60Hz	9 W ~ 60 W		
E27	80 CRI		



12251 GU10-LED



345 lm	RGB+TW	2700-6500 K	A ↑ G G
L 59, Ø 50	dimmable via remote & app		45°
4.9 W	15000 h		
220-240V, 50/60Hz	4.9 W ~ 50 W		
GU10	83 CRI		



110308 GU10-LED



400 lm	tunable WHITE	2700-6500 K	A ↑ G F
L 54, Ø 50	dimmable via remote & app		42°
4.9 W	25000 h		
220-240V, 50/60Hz	4.9 W ~ 57 W		
GU10	80 CRI		





12235 E27-LED-A60

806 lm	2200-6500 K	A ↑ G
L 105, Ø 60	dimmable via remote & app	
6 W	15000 h	
220-240V, 50/60Hz	6 W ~ 60 W	
E27	80 CRI	9 002759 122355



12241 E27-LED-A60

360 lm	2200-6500 K	A ↑ G
L 105, Ø 60	dimmable via remote & app	
4.9 W	15000 h	
220-240V, 50/60Hz	4.9 W ~ 33 W	
E27	80 CRI	9 002759 122416



Smart control made easy: Discover our entire **range of smart luminaires** sources in our luminaires source catalogue now.

Smarte Steuerung leicht gemacht: Entdecken Sie jetzt unser gesamtes **smartes Leuchtmittel Sortiment** in unserem Leuchtmittelkatalog.

Le contrôle intelligent en toute simplicité : découvrez dès maintenant **l'ensemble de notre gamme d'ampoules intelligentes** dans notre catalogue d'ampoules.

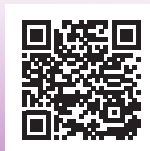

MAKE IT SMART

Retrofit your outdoor luminaires
Rüsten Sie Ihre Außenleuchten nach
Modernisez vos luminaires extérieurs



connect.z
bulb



connect.z
app

With our smart illuminants, you can create a harmonious setting for the patio, garden or paths around the house. Thanks to the timer function of your app, the bollard luminaires light up automatically at dusk, making paths safely visible and creating an inviting atmosphere with a view of the garden. And best of all, the light switches itself off at night - for efficient and effortless lighting.

Mit den smarten Leuchtmitteln lassen sich Terrasse, Garten oder Wege rund ums Haus harmonisch in Szene setzen. Dank der Zeitplanfunktion Ihrer App leuchten die Pollerleuchten bei Einbruch der Dämmerung automatisch aus, machen Wege sicher sichtbar und schaffen eine einladende Atmosphäre mit Blick in den Garten. Und das Beste: Nachts schaltet sich das Licht von selbst aus – für eine effiziente und mühelose Beleuchtung.

Les ampoules intelligentes permettent de mettre en scène harmonieusement la terrasse, le jardin ou les chemins autour de la maison. Grâce à la fonction de programmation de votre appli, les bornes lumineuses s'allument automatiquement à la tombée de la nuit, rendent les chemins visibles en toute sécurité et créent une atmosphère accueillante avec vue sur le jardin. Et le meilleur : la nuit, la lumière s'éteint d'elle-même - pour un éclairage efficace et sans effort.



connect.z
bulb

96



99106

connect.z
sensor

More security for your entrance area: Combine our smart illuminant sources with the **connect.z** motion detector and only switch the light on when someone enters the area. With the adjustable night light function, the light remains gently dimmed in the dark and automatically switches to full brightness when movement is detected.

Mehr Sicherheit für Ihren Eingangsbereich: Kombinieren Sie unsere smarten Leuchtmittel mit dem **connect.z** Bewegungsmelder und lassen Sie das Licht nur dann angehen, wenn jemand den Bereich betritt. Mit der einstellbaren Nachtlichtfunktion bleibt das Licht bei Dunkelheit sanft gedimmt und wechselt bei Bewegung automatisch auf volle Helligkeit.

Plus de sécurité pour votre entrée : combinez nos ampoules intelligentes avec le détecteur de mouvement **connect.z** et ne laissez la lumière s'allumer que lorsque quelqu'un pénètre dans la zone. Avec la fonction veilleuse réglable, la lumière reste doucement tamisée dans l'obscurité et passe automatiquement à pleine intensité en cas de mouvement.



MODERN

MODERN
MODERNE

EN **CLEAR LINES**

A straight-lined and minimalist design ensures a modern touch. The luminaires made of stainless steel, aluminium or steel, combined with refined glass elements, will make your outdoor area shine in a modern light.

DE **KLARE LINIEN**

Geradliniges und minimalistisches Design sorgt für einen modernen Touch. Die Leuchten aus Edelstahl, Aluminium oder Stahl, kombiniert mit edlen Glaselementen, lassen Ihren Außenbereich modern erstrahlen.

FR **LIGNES DISTINCTIVES**





Un design rectiligne et minimaliste apporte une touche de modernité. Les luminaires en acier inoxydable, en aluminium ou en acier, combinés à de nobles éléments en verre, font briller votre espace extérieur de modernité.





OVERVIEW

MODERN
MODERN
MODERNE

 RIFORANO 40-41	 NEMBRO 43	 MANFRIA 43	 DONINNI 1 44-45	 MELZO 46	 RIGOSA 48	 FIUMICINO 50-51	 PALOSCO 52
 CALDIERO 52	 STAGNONE 53	 NINNARELLA 54	 FORNACI 55	 NIVAROLO 55	 CHIAPPERA 56	 RAVELLO 58	 SELINUS 59
 UGENTO 61	 SALITTA 62	 NEVIANO 63	 SERRICELLA 64	 TAPARITA 64	 FANDINA 64	 VILLAGRAZIA 65	 VASCELLA 66-67
 MONTARELLO 68-69	 VERDOLINO 68-69	 BRISCOLA 68-69	 BELCREDA 70	 CHINOA 70	 MORINO 71	 REDONDO 71	 KIBEA 72
 PREDAZZO 72	 SESIMBA 1 73	 TREVIOLO 73	 LESMO 73	 FARINDOLA 75	 GORZANO 75	 BRIANZA 75	 BUFALATA 76
 COSTORIO 77	 BITETTO 77	 BUDRONE 79					

 This product is available in different colors and shapes. / Dieser Artikel ist in unterschiedlichen Farben und Formen verfügbar. / Cet article est disponible en différentes couleurs et formes.





98725



98727



98728



98725 RIFORANO

wall light; cast aluminium, black / plastic, white
Wandleuchte; Aluguss, schwarz / Kunststoff, weiss
Applique; fonte d'aluminium, noir / plastique, blanc

98727 RIFORANO

pedestal light; cast aluminium, black / plastic, white
Sockelleuchte; Aluguss, schwarz / Kunststoff, weiss
luminaire pour socle; fonte d'aluminium, noir / plastique, blanc

98728 RIFORANO

floor light; cast aluminium, black / plastic, white
Stehleuchte; Aluguss, schwarz / Kunststoff, weiss
lampadaire; fonte d'aluminium, noir / plastique, blanc

L 110, H 290, A 85



2 x 5 W
2 x 550 lm



9 002759 987251



A 85

L 110, B 60, H 340



2 x 5 W
2 x 550 lm



9 002759 987275



L 110

L 110, B 60, H 770



2 x 5 W
2 x 550 lm



9 002759 987282



L 110



98726



SAFETY &
COMFORT

120°, 6 m
10 sec. - 8 min.

98726 RIFORANO

wall light; cast aluminium, black / plastic, white
Wandleuchte; Aluguss, schwarz / Kunststoff, weiss
Applique; fonte d'aluminium, noir / plastique, blanc

L 110, H 290, A 95

LED

2 x
5 W

warm
WHITE

2 x
550 lm



IP44





98751

LED

HIGH
IP



98096



98097



98751 NEMBRO

floor light; cast aluminium, black / plastic, white
Stehleuchte; Aluguss, schwarz / Kunststoff, weiss
lampadaire; fonte d'aluminium, noir / plastique, blanc

L 200, B 110, H 800



1 x
10 W



1 x
1000 lm



IP54



9 002759 987510

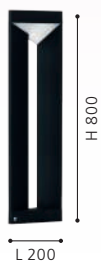

98096 MANFRIA

pedestal light; aluminium, anthracite, white
Sockelleuchte; Alu, anthrazit, weiss
luminaire pour socle; aluminium, gris anthracite, blanc

L 135, B 75, H 380



1 x
10 W



1 x
1100 lm



IP44



9 002759 980962



98097 MANFRIA

floor light; aluminium, anthracite, white
Stehleuchte; Alu, anthrazit, weiss
lampadaire; aluminium, gris anthracite, blanc

L 135, B 75, H 870



1 x
10 W



1 x
1100 lm



IP44



9 002759 980979





98266



98269



98271



98266 DONINNI 1

wall light; aluminium, white / plastic, white
Wandleuchte; Alu, weiss / Kunststoff, weiss
Applique; aluminium, blanc / plastique, blanc

L 135, B 120, H 75



98269 DONINNI 1

wall light; aluminium, anthracite / plastic, white
Wandleuchte; Alu, anthrazit / Kunststoff, weiss
Applique; aluminium, gris anthracite / plastique, blanc

L 135, B 120, H 75



98271 DONINNI 1

pedestal light; aluminium, anthracite / plastic, white
Sockelleuchte; Alu, anthrazit / Kunststoff, weiss
luminaire pour socle; aluminium, gris anthracite / plastique, blanc

L 135, B 75, H 400



9 002759 982669

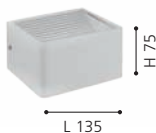

9 002759 982690



9 002759 982713





98272

LED

HIGH
IP

98272 DONINNI 1

floor light; aluminium, anthracite / plastic, white
Stehleuchte; Alu, anthrazit / Kunststoff, weiss
lampadaire; aluminium, gris anthracite / plastique, blanc

L 135, B 75, H 800

LED

1 x
6,2 W

warm
WHITE

1 x
550 lm



IP65



9 002759 982720



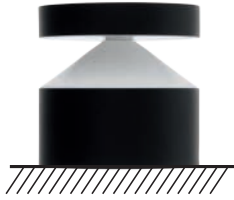
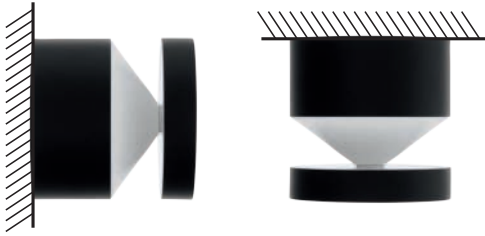

97303

These luminaires are versatile: they can be mounted both on the wall and on the ceiling. Floor placement is also possible thanks to the variable design of the luminaires.

Diese Leuchten sind vielseitig einsetzbar: Sie können sowohl an der Wand, als auch an der Decke montiert werden. Ebenfalls ist durch das variable Design der Leuchten eine Bodenplatzierung möglich.

Ces luminaires sont polyvalents : ils peuvent être montés aussi bien au mur qu'au plafond. De même, le design variable des luminaires permet de les placer au sol.



97632



97632 MELZO

pedestal light; cast aluminium, black / plastic, transparent
Sockelleuchte; Aluguss, schwarz / Kunststoff, transparent
luminaire pour socle; fonte d'aluminium, noir / plastique, transparent

H 450, Ø 135



1 x 11 W
1 x 1300 lm



9 002759 976323



Ø 135

97303 MELZO

wall light; cast aluminium, black / plastic, transparent
Wandleuchte; Aluguss, schwarz / Kunststoff, transparent
Applique; fonte d'aluminium, noir / plastique, transparent

H 130, Ø 135



1 x 11 W
1 x 1300 lm



9 002759 973032



Ø 135

97304 MELZO

floor light; cast aluminium, black / plastic, transparent
Stehleuchte; Aluguss, schwarz / Kunststoff, transparent
lampadaire; fonte d'aluminium, noir / plastique, transparent

H 990, Ø 135



1 x 11 W
1 x 1300 lm



9 002759 973049



Ø 135



97303

LED



97304

LED





901839

LED



901841

LED

901839 RIGOSA

wall light; steel, black / plastic, white
Wandleuchte; Stahl, schwarz / Kunststoff, weiss
Applique; acier, noir / plastique, blanc

Ø 185, A 100



1 x 10 W
1 x 1100 lm



9 008606 355815

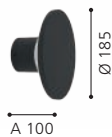

901841 RIGOSA

pedestal light; steel, black / plastic, white
Sockelleuchte; Stahl, schwarz / Kunststoff, weiss
luminaire pour socle; acier, noir / plastique, blanc

H 350, Ø 185



1 x 10 W
1 x 1100 lm



9 008606 355822



901842 RIGOSA

floor light; steel, black / plastic, white
Stehleuchte; Stahl, schwarz / Kunststoff, weiss
lampadaire; acier, noir / plastique, blanc

H 1000, Ø 185



1 x 10 W
1 x 1100 lm



9 008606 355839

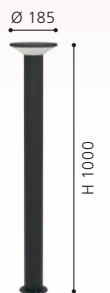



901842

LED



98148

LED



98149

LED



100°, 5 m
5 sec. - 5 min.

**SAFETY &
COMFORT**



98151

LED

98148 FIUMICINO

wall light; aluminium, black / plastic, white
Wandleuchte; Alu, schwarz / Kunststoff, weiss
Applique; aluminium, noir / plastique, blanc

L 70, H 180, A 190



1 x 11,5 W
1 x 1200 lm



9 002759 981488

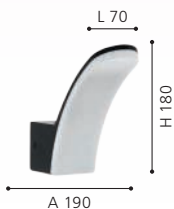

98149 FIUMICINO

wall light; aluminium, black / plastic, white
Wandleuchte; Alu, schwarz / Kunststoff, weiss
Applique; aluminium, noir / plastique, blanc

L 70, H 180, A 190

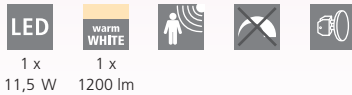

1 x 11,5 W
1 x 1200 lm



9 002759 981495



98151 FIUMICINO

pedestal light; aluminium, black / plastic, white
Sockelleuchte; Alu, schwarz / Kunststoff, weiss
luminaire pour socle; aluminium, noir / plastique, blanc

H 450, Base: B 110, T 80



1 x 11,5 W
1 x 1200 lm



9 002759 981518





98152 FIUMICINO

floor light; aluminium, black / plastic, white
Stehleuchte; Alu, schwarz / Kunststoff, weiss
lampadaire; aluminium, noir / plastique, blanc

H 900, Base: B 110, T 80

LED

1 x
11,5 W

warm
WHITE

1 x
1200 lm



IP44



9 002759 981525

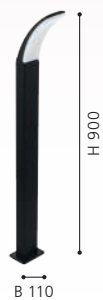

98152

LED



98738



90°, 6 m
10 sec. - 12 min.

**SAFETY &
COMFORT**



97146



97451



90°, 6 m
10 sec. - 10 min.

**SAFETY &
COMFORT**

98738 PALOSCO

wall light; zinc-plated steel, black / plastic, transparent
Wandleuchte; Stahl verzinkt, schwarz / Kunststoff, transparent
Applique; acier galvanisé, noir / plastique, transparent

L 115, H 170, A 155



1 x
4,9 W



1 x
360 lm



IP44



9 002759 987381



97451 CALDIERO

wall light; zinc-plated steel, anthracite / plastic, white
Wandleuchte; Stahl verzinkt, anthrazit / Kunststoff, weiss
Applique; acier galvanisé, gris anthracite / plastique, blanc

L 140, H 240, A 185



E27



1 x
10 W



IP44



9 002759 974510



97146 CALDIERO

wall light; zinc-plated steel, anthracite / plastic, white
Wandleuchte; Stahl verzinkt, anthrazit / Kunststoff, weiss
Applique; acier galvanisé, gris anthracite / plastique, blanc

L 140, H 240, A 185



E27



1 x
10 W



IP44



9 002759 971465





900691



900692



900691 STAGNONE

wall light; aluminium, steel, black / glass, clear
Wandleuchte; Alu, Stahl, schwarz / Glas, klar
Applique; aluminium, acier, noir / verre, transparent

L 100, H 205, A 125



GU10



1 x

4,6 W



1 x

400 lm



IP54



9 008606 261857



900692 STAGNONE

pedestal light; aluminium, steel, black / glass, clear
Sockelleuchte; Alu, Stahl, schwarz / Glas, klar
luminaire pour socle; aluminium, acier, noir / verre, transparent

L 100, B 125, H 1000



GU10



1 x

4,6 W



1 x

400 lm



IP54



9 008606 261864



22-23



900689

LED



900688

LED



900689 NINNARELLA

pedestal light; steel, black / plastic, white
 Sockelleuchte; Stahl, schwarz / Kunststoff, weiss
 luminaire pour socle; acier, noir / plastique, blanc

L 250, B 205, H 745

- 
GU10
- 
1 x
4,6 W
- 
warm
WHITE
1 x
400 lm
- 
IP44



9 008606 261840



900688 NINNARELLA

wall light; steel, black / plastic, white
 Wandleuchte; Stahl, schwarz / Kunststoff, weiss
 Applique; acier, noir / plastique, blanc

L 205, H 110, A 240

- 
GU10
- 
1 x
4,6 W
- 
warm
WHITE
1 x
400 lm
- 
IP44



9 008606 261833





900673



900674



90°, 8 m
10 sec. - 8 min.

**SAFETY &
COMFORT**



900675



900673 FORNACI

wall light; steel, black / plastic, white
Wandleuchte; Stahl, schwarz / Kunststoff, weiss
Applique; acier, noir / plastique, blanc

L 160, H 135, A 190



3 x 3,6 W
3 x 320 lm

900674 FORNACI

wall light; steel, black / plastic, white
Wandleuchte; Stahl, schwarz / Kunststoff, weiss
Applique; acier, noir / plastique, blanc

L 160, H 135, A 190

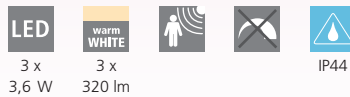

3 x 3,6 W
3 x 320 lm

900675 NIVAROLO

wall light; steel, black / plastic, white
Wandleuchte; Stahl, schwarz / Kunststoff, weiss
Applique; acier, noir / plastique, blanc

L 145, H 135, A 185



1 x 4,6 W
1 x 400 lm



9 008606 261710



9 008606 261727



9 008606 261734





900287



DESIGN
HIGHLIGHT
DETAIL



900802



900287 CHIAPPERA

wall light; steel, black, white / glass, clear
Wandleuchte; Stahl, schwarz, weiss / Glas, klar
Applique; acier, noir, blanc / verre, transparent

900802 CHIAPPERA

pedestal light; steel, black, white / glass, clear
Sockelleuchte; Stahl, schwarz, weiss / Glas, klar
luminaire pour socle; acier, noir, blanc / verre, transparent

900803 CHIAPPERA

path light; steel, black, white / glass, clear
Wegeleuchte; Stahl, schwarz, weiss / Glas, klar
Éclairage du chemin; acier, noir, blanc / verre, transparent

L 220, H 225, A 245

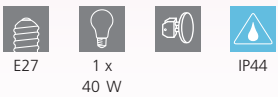

H 330, Ø 220



H 800, Ø 220





900803





98721



98723



98721 RAVELLO

wall light; zinc-plated steel, black / plastic, white
 Wandleuchte; Stahl verzinkt, schwarz / Kunststoff, weiss
 Applique; acier galvanisé, noir / plastique, blanc

L 165, H 275, A 225



9 002759 987213



98723 RAVELLO

pedestal light; zinc-plated steel, black / plastic, white
 Sockelleuchte; Stahl verzinkt, schwarz / Kunststoff, weiss
 luminaire pour socle; acier galvanisé, noir / plastique, blanc

H 450, Ø 165, Base: Ø 115



9 002759 987237





900672



900684



900672 SELINUS

wall light; steel, black / glass, clear
Wandleuchte; Stahl, schwarz / Glas, klar
Applique; acier, noir / verre, transparent

L 190, H 220, A 220



E27



1 x
40 W



IP65



9 008606 261680



900684 SELINUS

floor light; steel, black / glass, clear
Stehleuchte; Stahl, schwarz / Glas, klar
lampadaire; acier, noir / verre, transparent

L 290, B 190, H 845, Base: Ø 140



E27



1 x
40 W



IP65



9 008606 261697





900709

LED

900709

Regarding to its flexible head, these luminaires can be radiate forward or backward.

Diese Leuchten können durch ihren flexiblen Kopf nach vorne oder hinten strahlen.

Grâce à sa tête flexible, cette luminaires peut être rayonner vers l'avant ou vers l'arrière.

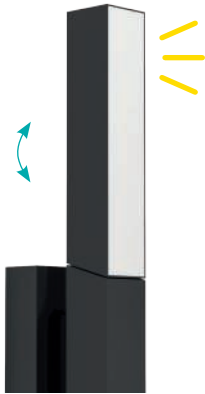

900709 UGENTO

wall light; steel, black / plastic, white
Wandleuchte; Stahl, schwarz / Kunststoff, weiss
Applique; acier, noir / plastique, blanc

L 60, H 315, A 95



2 x 4,5 W
2 x 460 lm

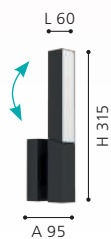

900992 UGENTO

pedestal light; aluminium, steel, black / plastic, white
Sockelleuchte; Alu, Stahl, schwarz / Kunststoff, weiss
luminaire pour socle; aluminium, acier, noir / plastique, blanc

L 145, B 40, H 360, Base: B 85, T 85



2 x 4,5 W
2 x 480 lm



900993 UGENTO

floor light; aluminium, steel, black / plastic, white
Stehleuchte; Alu, Stahl, schwarz / Kunststoff, weiss
lampadaire; aluminium, acier, noir / plastique, blanc

L 165, B 40, H 790, Base: B 85, T 85



2 x 4,5 W
2 x 480 lm

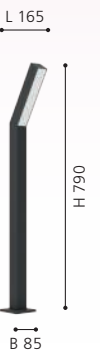



900262

LED



900261

LED



900262 SALITTA

surface-mounted light; aluminium, steel, black / plastic, white
 Aufbauleuchte; Alu, Stahl, schwarz / Kunststoff, weiss
 luminaire en saillie; aluminium, acier, noir / plastique, blanc

L 580, B 55, H 55



1 x
14 W



1 x
1680 lm



IP65



9 008606 232710



900261 SALITTA

surface-mounted light; aluminium, steel, black / plastic, white
 Aufbauleuchte; Alu, Stahl, schwarz / Kunststoff, weiss
 luminaire en saillie; aluminium, acier, noir / plastique, blanc

L 380, B 55, H 55



1 x
9 W



1 x
1080 lm



IP65



9 008606 232703





900677



900678



900676



900677 NEVIANO

wall light; steel, plastic, black / plastic, white
Wandleuchte; Stahl, Kunststoff, schwarz / Kunststoff, weiss
Applique; acier, plastique, noir / plastique, blanc

L 580, H 65, A 50



2 x 7 W 2 x 1050 lm

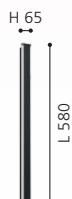

9 008606 261949

900678 NEVIANO

wall light; steel, plastic, black / plastic, white
Wandleuchte; Stahl, Kunststoff, schwarz / Kunststoff, weiss
Applique; acier, plastique, noir / plastique, blanc

L 970, H 65, A 50



2 x 11 W 2 x 2100 lm



9 008606 261956

900676 NEVIANO

wall light; steel, plastic, black / plastic, white
Wandleuchte; Stahl, Kunststoff, schwarz / Kunststoff, weiss
Applique; acier, plastique, noir / plastique, blanc

L 380, H 65, A 50



2 x 3,7 W 2 x 600 lm



9 008606 261932

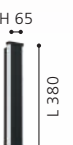



900133

LED



900681

LED



900118

LED



900133 SERRICELLA

wall light; zinc-plated steel, black / plastic, white
Wandleuchte; Stahl verzinkt, schwarz / Kunststoff, weiss
Applique; acier galvanisé, noir / plastique, blanc

L 100, H 495, A 60



9 008606 230174



900681 TAPARITA

wall light; steel, black / plastic, white
Wandleuchte; Stahl, schwarz / Kunststoff, weiss
Applique; acier, noir / plastique, blanc

L 90, H 440, A 110



9 008606 261741



900118 FANDINA

wall light; zinc-plated steel, black / plastic, white
Wandleuchte; Stahl verzinkt, schwarz / Kunststoff, weiss
Applique; acier galvanisé, noir / plastique, blanc

L 145, H 415, A 55



9 008606 230150





98154 VILLAGRAZIA

wall light; aluminium, black / glass with air bubbles, clear
 Wandleuchte; Alu, schwarz / Glas mit Lufteinschlüssen, klar
 Applique; aluminium, noir / verre avec bulles d'air, transparent

L 120, H 400, A 70



2 x
3,3 W



2 x
340 lm



IP44

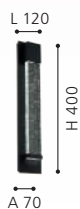

98153 VILLAGRAZIA

wall light; aluminium, black / glass with air bubbles, clear
 Wandleuchte; Alu, schwarz / Glas mit Lufteinschlüssen, klar
 Applique; aluminium, noir / verre avec bulles d'air, transparent

L 120, H 300, A 70



2 x
3,3 W



2 x
340 lm



IP44





902221



902223



902221 VASCELLA

wall light; stainless steel, black / plastic, white
 Wandleuchte; Edelstahl, schwarz / Kunststoff, weiss
 Applique; acier inoxydable, noir / plastique, blanc

L 600, H 90, A 50



1 x
12 W



1 x
1600 lm



IP44



9 008606 357017

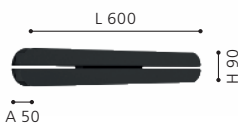

902223 VASCELLA

wall light; stainless steel, white / plastic, white
 Wandleuchte; Edelstahl, weiss / Kunststoff, weiss
 Applique; acier inoxydable, blanc / plastique, blanc

L 600, H 90, A 50



1 x
12 W



1 x
1600 lm



IP44



9 008606 357031

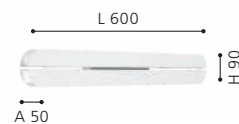



902219

LED



902222

LED

902219 VASCELLA

wall light; stainless steel, black / plastic, white
Wandleuchte; Edelstahl, schwarz / Kunststoff, weiss
Applique; acier inoxydable, noir / plastique, blanc

Ø 180, A 40

LED

1 x
5 W

3
COLOR

1 x
600 lm



IP44



9 008606 357000



A 40

902222 VASCELLA

wall light; stainless steel, white / plastic, white
Wandleuchte; Edelstahl, weiss / Kunststoff, weiss
Applique; acier inoxydable, blanc / plastique, blanc

Ø 180, A 40

LED

1 x
5 W

3
COLOR

1 x
600 lm



IP44



9 008606 357024



A 40



902024



902022



902019



902024 MONTARELLO

wall light; steel, white
Wandleuchte; Stahl, weiss
Applique; acier, blanc

L 110, H 275, A 75



2 x 4 W
2 x 600 lm



9 008606 360512



902022 VERDOLINO

wall light; steel, white
Wandleuchte; Stahl, weiss
Applique; acier, blanc

L 120, H 280, A 80

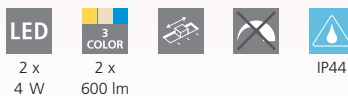

2 x 4 W
2 x 600 lm



9 008606 360499



902019 BRISCOLA

wall light; steel, white
Wandleuchte; Stahl, weiss
Applique; acier, blanc

L 120, H 250, A 60



2 x 4 W
2 x 600 lm



9 008606 360475

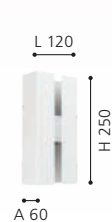



902023



902021



902018



902023 MONTARELLO

wall light; steel, black
Wandleuchte; Stahl, schwarz
Applique; acier, noir

L 110, H 275, A 75



2 x
4 W



2 x
600 lm



IP44



9 008606 360505



902021 VERDOLINO

wall light; steel, black
Wandleuchte; Stahl, schwarz
Applique; acier, noir

L 120, H 280, A 80



2 x
4 W



2 x
600 lm



IP44



9 008606 360482



902018 BRISCOLA

wall light; steel, black
Wandleuchte; Stahl, schwarz
Applique; acier, noir

L 120, H 250, A 60



2 x
4 W



2 x
600 lm



IP44



9 008606 360468

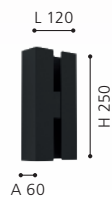

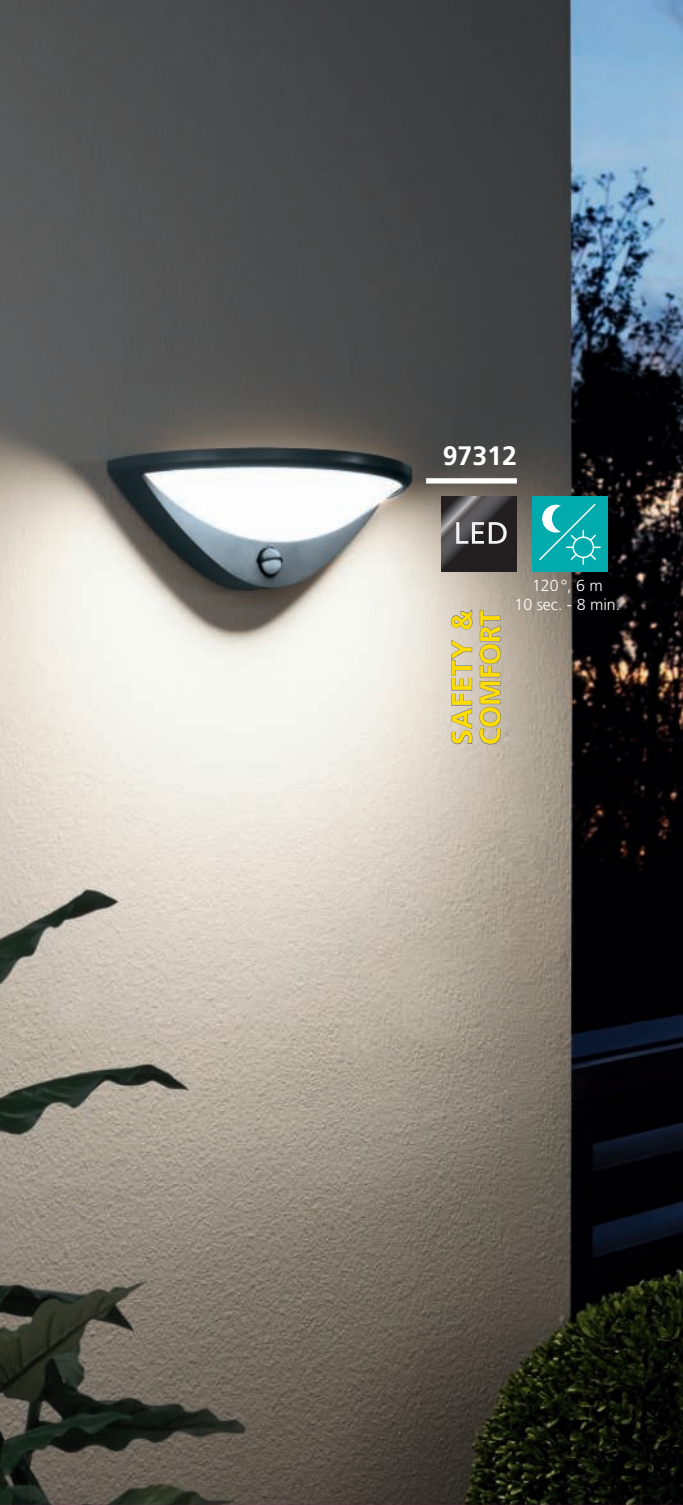

97312



120°, 6 m
10 sec. - 8 min.

**SAFETY &
COMFORT**



98711



98709



97312 BELCREDA

wall light; cast aluminium, anthracite / plastic, white
Wandleuchte; Aluguss, anthrazit / Kunststoff, weiss
Applique; fonte d'aluminium, gris anthracite / plastique, blanc

L 330, H 125, A 165

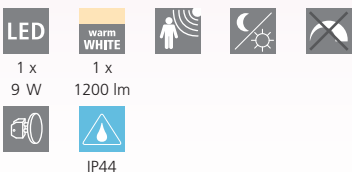

98711 CHINOA

wall light; aluminium, steel, anthracite / plastic, transparent
Wandleuchte; Alu, Stahl, anthrazit / Kunststoff, transparent
Applique; aluminium, acier, gris anthracite / plastique, transparent

L 270, H 75, A 135



98709 CHINOA

wall light; aluminium, steel, white / plastic, transparent
Wandleuchte; Alu, Stahl, weiss / Kunststoff, transparent
Applique; aluminium, acier, blanc / plastique, transparent

L 270, H 75, A 135





93319



93368



93318



93319 MORINO

wall light; cast aluminium, anthracite
Wandleuchte; Aluguss, anthrazit
Applique; fonte d'aluminium, gris anthracite

L 140, H 180, A 105



2 x
2,5 W



2 x
230 lm



IP44

L 140

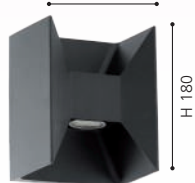

A 105



9 002759 933197

93318 MORINO

wall light; cast aluminium, white
Wandleuchte; Aluguss, weiss
Applique; fonte d'aluminium, blanc

L 140, H 180, A 105



2 x
2,5 W



2 x
230 lm



IP44

L 140

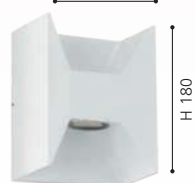

A 105



9 002759 933180

93368 REDONDO

wall light; cast aluminium, anthracite
Wandleuchte; Aluguss, anthrazit
Applique; fonte d'aluminium, gris anthracite

L 160, H 175, A 125



2 x
2,5 W



2 x
230 lm



IP44

L 160

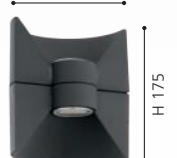

A 125



9 002759 933685



93254



93994



93254 KIBEA

wall light; zinc-plated steel, white, anthracite
Wandleuchte; Stahl verzinkt, weiss, anthrazit
Applique; acier galvanisé, blanc, gris anthracite

L 150, H 260, A 75



2 x
2,5 W



2 x
230 lm



IP54



9 002759 932541



93994 PREDAZZO

wall light; zinc-plated steel, anthracite, white
Wandleuchte; Stahl verzinkt, anthrazit, weiss
Applique; acier galvanisé, gris anthracite, blanc

L 140, H 210, A 75



2 x
2,5 W



2 x
230 lm



IP44



9 002759 939946

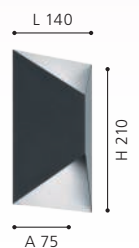



96021



90°, 6 m
10 sec. - 10 min.

**SAFETY &
COMFORT**



98746



900292



96021 SESIMBA 1

wall light; zinc-plated steel, black / plastic, clear
Wandleuchte; Stahl verzinkt, schwarz / Kunststoff, klar
Applique; acier galvanisé, noir / plastique, transparent

L 130, H 195, A 140



2 x
3,7 W



2 x
330 lm



IP44



9 002759 960216



98746 TREVILO

wall light; cast aluminium, anthracite / glass, clear
Wandleuchte; Aluguss, anthrazit / Glas, klar
Applique; fonte d'aluminium, gris anthracite / verre, transparent

L 90, H 85, A 120



2 x
2,2 W



2 x
230 lm



IP44



9 002759 987466



900292 LESMO

wall light; cast aluminium, black / glass, clear
Wandleuchte; Aluguss, schwarz / Glas, klar
Applique; fonte d'aluminium, noir / verre, transparent

L 240, H 105, A 115



4 x
2,8 W



4 x
390 lm



IP44



9 008606 231560

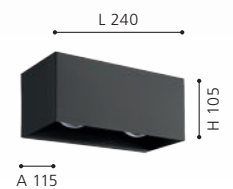



900682



97222



98707



98707



98707

The movable light head allows you to select different lighting scenes as required.

Durch den beweglichen Leuchtenkopf können Sie nach Belieben unterschiedliche Lichtszenen wählen.

La tête de luminaire mobile vous permet de sélectionner différentes scènes lumineuses en fonction de vos besoins.

900682 FARINDOLA

wall light; steel, black / plastic, white
Wandleuchte; Stahl, schwarz / Kunststoff, weiss
Applique; acier, noir / plastique, blanc

L 115, H 325, A 155



E27



1 x
25 W



IP44

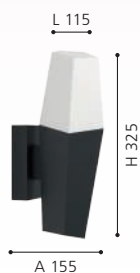

9 008606 261703

97222 GORZANO

wall light; zinc-plated steel, anthracite / plastic, satin finish
Wandleuchte; Stahl verzinkt, anthrazit / Kunststoff, satiniert
Applique; acier galvanisé, gris anthracite / plastique, satiné

L 80, H 290, A 105



1 x
4,8 W



1 x
550 lm



IP44



9 002759 972226



98707 BRIANZA

wall light; cast aluminium, black
Wandleuchte; Aluguss, schwarz
Applique; fonte d'aluminium, noir

L 200, H 50, A 140



1 x
4,8 W



1 x
550 lm



IP44



9 002759 987077





900671



900669

900671 BUFALATA

wall light; steel, black, brown / plastic, black-transparent
 Wandleuchte; Stahl, schwarz, braun / Kunststoff, schwarz-transparent
 Applique; acier, noir, marron / plastique, noir transparent

L 200, H 290, A 275



E27



1 x
40 W



IP44



9 008606 261765



900669 BUFALATA

wall light; steel, black / plastic, white
 Wandleuchte; Stahl, schwarz / Kunststoff, weiss
 Applique; acier, noir / plastique, blanc

L 200, H 290, A 275



E27



1 x
40 W



IP44



9 008606 261758





900291

LED



900679

LED

900291 COSTORIO

wall light; aluminium, black, brown
Wandleuchte; Alu, schwarz, braun
Applique; aluminium, noir, marron

L 370, B 80, H 80



1 x
11,7 W



1 x
1500 lm



IP44



9 008606 231638



900679 BITETTO

wall light; steel, brown / plastic, white
Wandleuchte; Stahl, braun / Kunststoff, weiss
Applique; acier, marron / plastique, blanc

L 120, H 430, A 55



1 x
7 W



1 x
770 lm



IP44



9 008606 261772





900289

BUDRONE

These luminaires can be mounted upwards or downwards.

Diese Leuchten können aufwärts oder abwärts montiert werden.

Ces luminaires peut être montée vers le haut ou vers le bas.



900288

DESIGN
HIGHLIGHT
DETAIL



900289 BUDRONE

wall light; steel, black, brown / glass, clear
Wandleuchte; Stahl, schwarz, braun / Glas, klar
Applique; acier, noir, marron / verre, transparent

L 120, H 270, A 165



E27



1 x
40 W



IP44



9 008606 231591

900288 BUDRONE

wall light; steel, black / glass, clear
Wandleuchte; Stahl, schwarz / Glas, klar
Applique; acier, noir / verre, transparent

L 120, H 270, A 165



E27



1 x
40 W



IP44



9 008606 231607



TIMELESS

ZEITLOS
SANS TEMPS



EN TIMELESS CLASSICS

Our outdoor lamps bring timeless sophistication to every corner, creating an inviting ambiance that withstands the test of time and nature.

DE ZEITLOSE KLASSIKER

Unsere Außenleuchten verleihen jeder Ecke zeitlose Raffinesse und schaffen eine einladende Atmosphäre, die den Lauf der Zeit und die Einflüsse der Natur überdauert.

FR DES CLASSIQUES INTEMPORELS

Nos luminaires d'extérieur confèrent à chaque coin un raffinement intemporel et créent une atmosphère accueillante qui résiste au passage du temps et aux influences de la nature.





OVERVIEW

TIMELESS
ZEITLOS
SANS TEMPS

 ALAMONTE 3 84-85	 ALAMONTE 86	 ALAMONTE 1 86-88	 ALAMONTE SMOKE 89	 CASCINETTA 90	 SALLE 92	 HELSINKI 95-97	 TOMELLOSO 98-99
 RIGA 100-101	 RIGA 5 102-103	 ATOLLARI 103	 CISTIENA 104-105	 BEVERLY 105	 ROBLEDO 105	 AGOLADA 106	 RIGA-LED 107
 IZZALINI 108	 TORRECOLA 109	 GRUTTI 110	 EREMITANA 111	 JABAGA 111	 SPONGANO 112	 MARUGGIO 113	 CALPINO 2 114
 CALPINO 114	 CALPINO 3 115-117	 SAKEDA 118	 JORBA 118	 DESELLA 1 118	 CAMARDA 120-121	 BREGANZO 1 123	 PARK 123
 TRIBANO 123	 STOCKHOLM 1 124	 CERNO 124-125	 CITY 126-127	 ARGOLIS 2 128-129	 IPHIAS 2 128	 APPRODO 130-131	 MARGIDORE 131
 MINERARIO 132-135	 CASTAGNETO 136-137	 CASTAGNETO-M 137	 SONELLA 138	 CORNALE 138	 VENTO 2 139	 VENTO 1 139	 MADRIZ 140

 This product is available in different colors and shapes. / Dieser Artikel ist in unterschiedlichen Farben und Formen verfügbar. / Cet article est disponible en différentes couleurs et formes.



AZZINANO
141



MUSSOTTO
141



VERRES
141



PRATA VECCHIA
142



TAVERNA
142



MONTEROLO
144



ZANCARO
145



ZANCARO 1
145

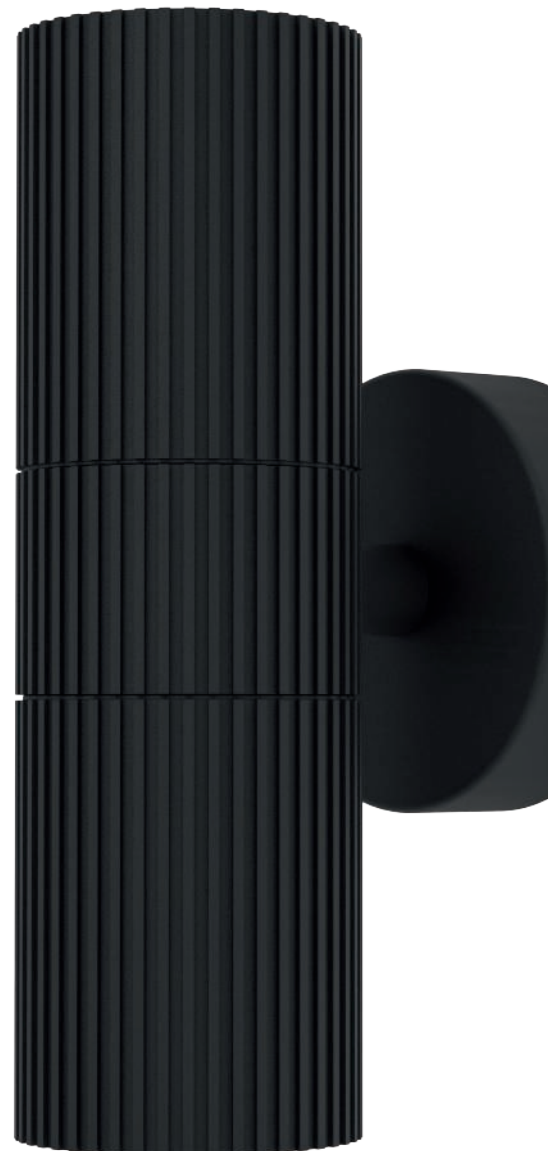



900137



90°, 6 m
10 sec. - 12 min.

**SAFETY &
COMFORT**



900138

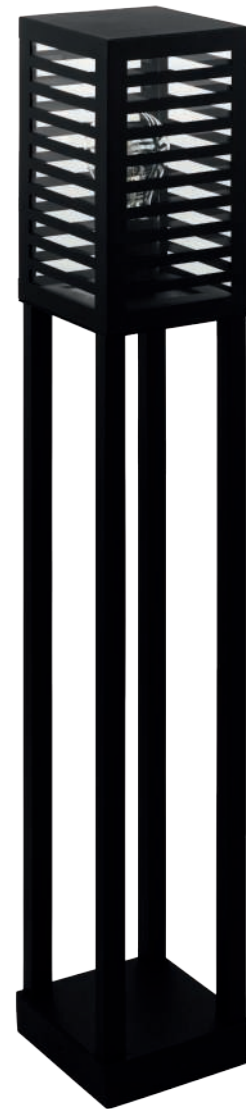

900139

900137 ALAMONTE 3

wall light; aluminium, steel, black
Wandleuchte; Alu, Stahl, schwarz
Applique; aluminium, acier, noir

L 170, H 295, A 100



E27



1 x
60 W



IP44



9 008606 230112



A 100

900138 ALAMONTE 3

pedestal light; aluminium, steel, black
Sockelleuchte; Alu, Stahl, schwarz
luminaire pour socle; aluminium, acier, noir

L 150, B 150, H 450



E27



1 x
60 W



IP44



9 008606 230129



L 150

900139 ALAMONTE 3

floor light; aluminium, steel, black
Stehleuchte; Alu, Stahl, schwarz
lampadaire; aluminium, acier, noir

L 150, B 150, H 1000



E27



1 x
60 W



IP44



9 008606 230136



L 150



900136

900136 ALAMONTE 3

wall light; aluminium, steel, black
 Wandleuchte; Alu, Stahl, schwarz
 Applique; aluminium, acier, noir

L 170, H 260, A 100



E27



1 x
60 W



IP44



9 008606 230105





99587



105°, 9 m
8 sec. - 9 min.

**SAFETY &
COMFORT**



98273



94831

99587 ALAMONTE

wall light; steel, black / glass, clear
Wandleuchte; Stahl, schwarz / Glas, klar
Applique; acier, noir / verre, transparent

L 170, H 295, A 115



E27
1 x
60 W



9 002759 995874



98273 ALAMONTE 1

wall light; steel, black / glass, clear
Wandleuchte; Stahl, schwarz / Glas, klar
Applique; acier, noir / verre, transparent

L 150, H 380, A 100



E27
2 x
60 W
IP44



9 002759 982737



94831 ALAMONTE 1

wall light; steel, black / glass, clear
Wandleuchte; Stahl, schwarz / Glas, klar
Applique; acier, noir / verre, transparent

L 170, H 260, A 100



E27
1 x
40 W
IP44



9 002759 948313





900698



94832

900698 ALAMONTE 1

wall light; steel, black / glass, clear
Wandleuchte; Stahl, schwarz / Glas, klar
Applique; acier, noir / verre, transparent

L 290, H 260, A 100



E27



2 x
40 W



IP44



9 008606 255917



94832 ALAMONTE 1

wall/ceiling light; steel, black / glass, clear
Wand- / Deckenleuchte; Stahl, schwarz / Glas, klar
Applique/Plafonnier; acier, noir / verre, transparent

L 290, H 290, A 130



E27



2 x
28 W



IP44



9 002759 948320



94832

This luminaire can be mounted as a wall or ceiling luminaire.

Diese Leuchten können als Wand- oder Deckenleuchte montiert werden.

Ce luminaire peut être monté en tant qu'applique murale ou plafonnier.



94788



94833

94788 ALAMONTE 1

pendant light; steel, black / glass, clear
 Hängeleuchte; Stahl, schwarz / Glas, klar
 luminaire en suspension; acier, noir / verre, transparent

L 150, B 150, H 1130



E27



1 x
60 W



IP44



9 002759 947880



H 1130

L 150

94833 ALAMONTE 1

floor light; steel, black / glass, clear
 Stehleuchte; Stahl, schwarz / Glas, klar
 lampadaire; acier, noir / verre, transparent

L 150, B 150, H 1015, Base: Ø 110



E27



1 x
60 W



IP44



9 002759 948337



H 1015

Ø 110



31566



33627



31566 ALAMONTE SMOKE

wall light; steel, black / glass, black-transparent
Wandleuchte; Stahl, schwarz / Glas, schwarz-transparent
Applique; acier, noir / verre, noir transparent

L 290, H 260, A 100



E27



2 x
40 W



IP44



9 002759 315665

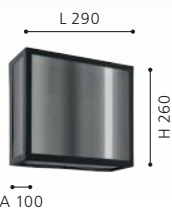

33627 ALAMONTE SMOKE

wall light; zinc-plated steel, black / glass vaporized, black-transparent
Wandleuchte; Stahl verzinkt, schwarz / Glas bedampft, schwarz-transparent
Applique; acier galvanisé, noir / verre vaporisé, noir transparent

L 170, H 260, A 100



E27



1 x
60 W



IP44



9 002759 336271





98713



98715



98713 CASCINETTA

wall light; zinc-plated steel, black / glass, clear
Wandleuchte; Stahl verzinkt, schwarz / Glas, klar
Applique; acier galvanisé, noir / verre, transparent

L 165, H 280, A 165

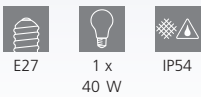

9 002759 987138



A 165

98715 CASCINETTA

floor light; cast aluminium, black / glass, clear
Stehleuchte; Aluguss, schwarz / Glas, klar
lampadaire; fonte d'aluminium, noir / verre, transparent

L 150, B 150, H 795

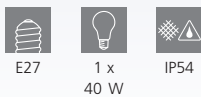

9 002759 987152



L 150

98714 CASCINETTA

pedestal light; cast aluminium, black / glass, clear
Sockelleuchte; Aluguss, schwarz / Glas, klar
luminaire pour socle; fonte d'aluminium, noir / verre, transparent

L 150, B 150, H 305

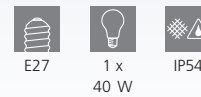

9 002759 987145



L 150



98714



DESIGN
HIGHLIGHT
DETAIL



901034



901035



901034 SALLE

pedestal light; aluminium, plastic, black / plastic, black-transparent
Sockelleuchte; Alu, Kunststoff, schwarz / Kunststoff, schwarz-transparent
luminaire pour socle; aluminium, plastique, noir / plastique, noir transparent
H 465, Ø 75



901035 SALLE

floor light; aluminium, plastic, black / plastic, black-transparent
Stehleuchte; Alu, Kunststoff, schwarz / Kunststoff, schwarz-transparent
lampadaire; aluminium, plastique, noir / plastique, noir transparent

H 1100, Ø 75, Base: Ø 75

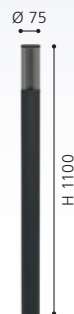

901033 SALLE

wall light; aluminium, plastic, black / plastic, black-transparent
Wandleuchte; Alu, Kunststoff, schwarz / Kunststoff, schwarz-transparent
Applique; aluminium, plastique, noir / plastique, noir transparent

H 310, Ø 75, A 105

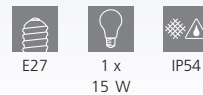



901033





900986



120° - 6 m
10 sec. - 5 min.

**SAFETY &
COMFORT**



900985



120°, 6 m
10 sec. - 5 min.

**SAFETY &
COMFORT**



900987



120°, 6 m
10 sec. - 5 min.

**SAFETY &
COMFORT**

900986 HELSINKI

pedestal light; stainless steel, auburn / plastic, black-transparent
Sockelleuchte; Edelstahl, rostbraun / Kunststoff, schwarz-transparent

luminaire pour socle; acier inoxydable, brun rouille / plastique, noir transparent

H 450, Ø 75, Base: Ø 115



E27



1 x
15 W



IP44



9 008606 298167

900985 HELSINKI

wall light; stainless steel, auburn / plastic, black-transparent
Wandleuchte; Edelstahl, rostbraun / Kunststoff, schwarz-transparent

Applique; acier inoxydable, brun rouille / plastique, noir transparent

H 400, Ø 75, A 165



E27



1 x
15 W



IP44



9 008606 298150

900987 HELSINKI

floor light; stainless steel, auburn / plastic, black-transparent
Stehleuchte; Edelstahl, rostbraun / Kunststoff, schwarz-transparent

lampadaire; acier inoxydable, brun rouille / plastique, noir transparent

H 1100, Ø 75, Base: Ø 115



E27



1 x
15 W



IP44

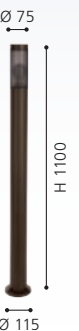

9 008606 298174



83278



110°, 5 m
15 sec. - 7 min.

**SAFETY &
COMFORT**



81751



HIGH
IP



81753



HIGH
IP

81751 HELSINKI

floor light; stainless steel, stainless steel / plastic, white
Stehleuchte; Edelstahl, edelstahl / Kunststoff, weiss
lampadaire; acier inoxydable, acier inoxydable / plastique, blanc

H 450, Ø 75, Base: Ø 115



9 002759 817510



83278 HELSINKI

wall light; stainless steel, stainless steel / plastic, white
Wandleuchte; Edelstahl, edelstahl / Kunststoff, weiss
Applique; acier inoxydable, acier inoxydable / plastique, blanc

H 425, Ø 75, A 165



9 002759 832780



81753 HELSINKI

wall light; stainless steel, stainless steel / plastic, white
Wandleuchte; Edelstahl, edelstahl / Kunststoff, weiss
Applique; acier inoxydable, acier inoxydable / plastique, blanc

H 390, Ø 75, A 165



9 002759 817534





83279



110°, 5 m
15 sec. - 7 min.

**SAFETY &
COMFORT**



83281



110°, 5 m
15 sec. - 7 min.

**SAFETY &
COMFORT**



81752



HIGH
IP

83279 HELSINKI

floor light; stainless steel, stainless steel / plastic, white
Stehleuchte; Edelstahl, edelstahl / Kunststoff, weiss
lampadaire; acier inoxydable, acier inoxydable / plastique, blanc

H 450, Ø 75, Base: Ø 115



E27



1 x
12 W



IP44

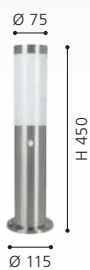

9 002759 832797

83281 HELSINKI

floor light; stainless steel, stainless steel / plastic, white
Stehleuchte; Edelstahl, edelstahl / Kunststoff, weiss
lampadaire; acier inoxydable, acier inoxydable / plastique, blanc

H 1100, Ø 75, Base: Ø 115



E27



1 x
12 W



IP44

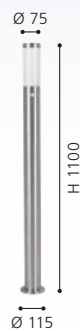

9 002759 832810

81752 HELSINKI

floor light; stainless steel, stainless steel / plastic, white
Stehleuchte; Edelstahl, edelstahl / Kunststoff, weiss
lampadaire; acier inoxydable, acier inoxydable / plastique, blanc

H 1100, Ø 75, Base: Ø 115



E27



1 x
12 W



IP65

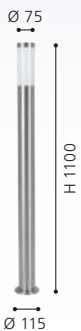

9 002759 817527



902038

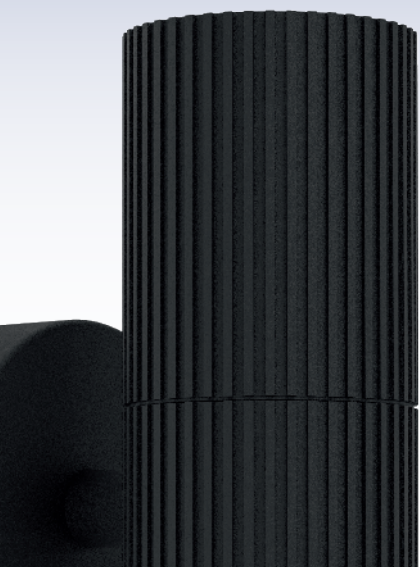

902038 TOMELLOSO

wall light; aluminium, black / glass, clear
Wandleuchte; Alu, schwarz / Glas, klar
Applique; aluminium, noir / verre, transparent

L 60, H 200, A 110



GU10



2 x
28 W



IP44



9 008606 355990

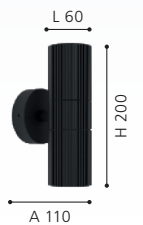

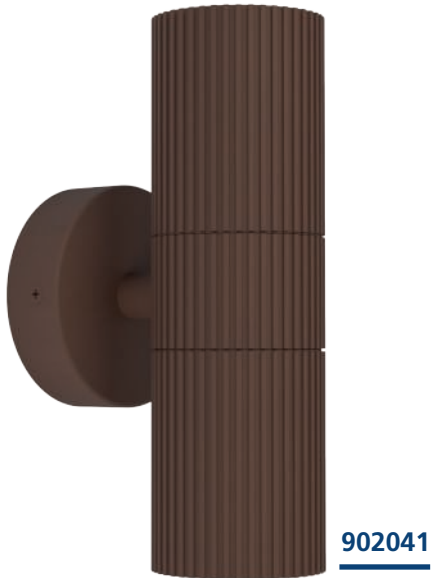

902041



902037



902039

902041 TOMELLOSO

wall light; aluminium, rust-coloured / glass, clear
Wandleuchte; Alu, rostfarben / Glas, klar
Applique; aluminium, rouille / verre, transparent

L 60, H 200, A 110



GU10



2 x
28 W



IP44



9 008606 356010

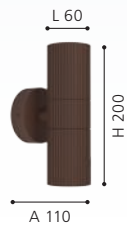

902037 TOMELLOSO

wall light; aluminium, black / glass, clear
Wandleuchte; Alu, schwarz / Glas, klar
Applique; aluminium, noir / verre, transparent

L 60, H 120, A 110



GU10



1 x
28 W



IP44



9 008606 355983

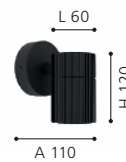

902039 TOMELLOSO

wall light; aluminium, rust-coloured / glass, clear
Wandleuchte; Alu, rostfarben / Glas, klar
Applique; aluminium, rouille / verre, transparent

L 60, H 120, A 110



GU10



1 x
28 W



IP44



9 008606 356003

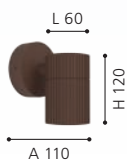



94107

LED



94106

LED



94103

LED

94107 RIGA

wall light; stainless steel, stainless steel
Wandleuchte; Edelstahl, edelstahl
Applique; acier inoxydable, acier inoxydable

94106 RIGA

wall light; stainless steel, stainless steel
Wandleuchte; Edelstahl, edelstahl
Applique; acier inoxydable, acier inoxydable

94103 RIGA

wall light; zinc-plated steel, anthracite
Wandleuchte; Stahl verzinkt, anthrazit
Applique; acier galvanisé, gris anthracite

L 65, H 200, A 95

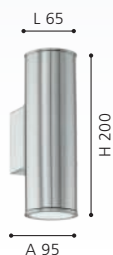
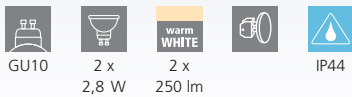

L 65, H 150, A 95

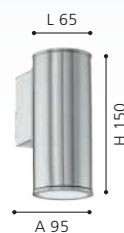
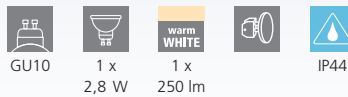

L 65, H 200, A 95

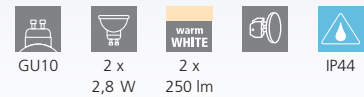



94105

LED



94102

LED



94101

LED

94105 RIGA

wall light; zinc-plated steel, antique brown
Wandleuchte; Stahl verzinkt, antik-braun
Applique; acier galvanisé, marron antique

L 65, H 200, A 95



GU10



2 x
2,8 W



warm
WHITE
2 x
250 lm



IP44

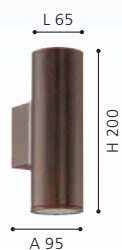

9 002759 941055



94102 RIGA

wall light; zinc-plated steel, anthracite
Wandleuchte; Stahl verzinkt, anthrazit
Applique; acier galvanisé, gris anthracite

L 65, H 150, A 95



GU10



1 x
2,8 W



warm
WHITE
1 x
250 lm



IP44



9 002759 941024



94101 RIGA

wall light; zinc-plated steel, white
Wandleuchte; Stahl verzinkt, weiss
Applique; acier galvanisé, blanc

L 65, H 200, A 95



GU10



2 x
2,8 W



warm
WHITE
2 x
250 lm



IP44



9 002759 941017





99569



90°, 6 m
10 sec. - 12 min.

**SAFETY &
COMFORT**



99571



90°, 6 m
10 sec. - 12 min.

**SAFETY &
COMFORT**



32898



100°, 6 m
10 sec. - 12 min.

**SAFETY &
COMFORT**

99569 RIGA 5

wall light; stainless steel, stainless steel / glass, clear
Wandleuchte; Edelstahl, edelstahl / Glas, klar
Applique; acier inoxydable, acier inoxydable / verre, transparent

L 65, H 165, A 110



GU10 1 x 2,8 W 1 x 250 lm



99571 RIGA 5

wall light; zinc-plated steel, black / glass, clear
Wandleuchte; Stahl verzinkt, schwarz / Glas, klar
Applique; acier galvanisé, noir / verre, transparent

L 65, H 165, A 110



GU10 1 x 2,8 W 1 x 250 lm



32898 RIGA 5

wall light; stainless steel, stainless steel / glass, clear
Wandleuchte; Edelstahl, edelstahl / Glas, klar
Applique; acier inoxydable, acier inoxydable / verre, transparent

L 65, H 215, A 110



GU10 2 x 2,8 W 2 x 250 lm





32899



100°, 6 m
10 sec. - 12 min.

**SAFETY &
COMFORT**



96276



90°, 6 m
10 sec. - 12 min.

**SAFETY &
COMFORT**



96277



100°, 6 m
10 sec. - 12 min.

**SAFETY &
COMFORT**

32899 RIGA 5

wall light; zinc-plated steel, anthracite / glass, clear
Wandleuchte; Stahl verzinkt, anthrazit / Glas, klar
Applique; acier galvanisé, gris anthracite / verre, transparent

L 65, H 215, A 110



GU10



2 x
2,8 W



2 x
250 lm



IP44



9 002759 328993

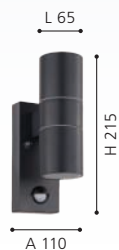

96277 ATOLLARI

wall light; cast aluminium, stainless steel, silver / plastic, white
Wandleuchte; Aluguss, edelstahl, silber / Kunststoff, weiss
Applique; fonte d'aluminium, acier inoxydable, argent / plastique, blanc

L 100, H 230, A 155



2 x
4,9 W



2 x
360 lm



IP44



9 002759 962777

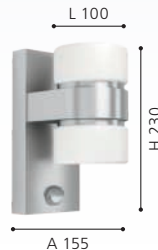

96276 ATOLLARI

wall light; cast aluminium, anthracite / plastic, white
Wandleuchte; Aluguss, anthrazit / Kunststoff, weiss
Applique; fonte d'aluminium, gris anthracite / plastique, blanc

L 100, H 230, A 155



2 x
4,9 W



2 x
360 lm



IP44



9 002759 962760

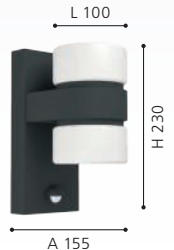



98086

DESIGN
HIGHLIGHT
DETAIL



98086 CISTIerna

wall light; zinc-plated steel, anthracite / plastic, white
Wandleuchte; Stahl verzinkt, anthrazit / Kunststoff, weiss
Applique; acier galvanisé, gris anthracite / plastique, blanc

L 180, H 350, A 90



E27



2 x
10 W



IP44



9 002759 980863

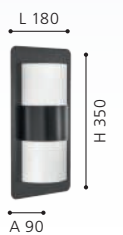



98085



86541



96013



98085 CISTIerna

wall light; stainless steel, stainless steel / plastic, white
Wandleuchte; Edelstahl, edelstahl / Kunststoff, weiss
Applique; acier inoxydable, acier inoxydable / plastique, blanc

L 180, H 350, A 90



E27



2 x
10 W



IP44



9 002759 980856

86541 BEVERLY

wall light; stainless steel, stainless steel, silver / satin glass, white
Wandleuchte; Edelstahl, edelstahl, silber / Glas satiniert, weiss
Applique; acier inoxydable, acier inoxydable, argent / verre satiné, blanc

L 200, H 350, A 135



E27



2 x
60 W



IP44

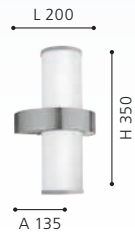

9 002759 865412

96013 ROBLED0

wall light; stainless steel, stainless steel / plastic, transparent
Wandleuchte; Edelstahl, edelstahl / Kunststoff, transparent
Applique; acier inoxydable, acier inoxydable / plastique, transparent

L 75, H 260, A 120



2 x

3,7 W



2 x

330 lm



IP44



9 002759 960131



94804



94803



94804 AGOLADA

wall light; zinc-plated steel, black, copper
 Wandleuchte; Stahl verzinkt, schwarz, kupfer
 Applique; acier galvanisé, noir, cuivre

L 75, H 360, A 110



L 75



94803 AGOLADA

wall light; stainless steel, stainless steel, white
 Wandleuchte; Edelstahl, edelstahl, weiss
 Applique; acier inoxydable, acier inoxydable, blanc

L 75, H 360, A 110



L 75





92736

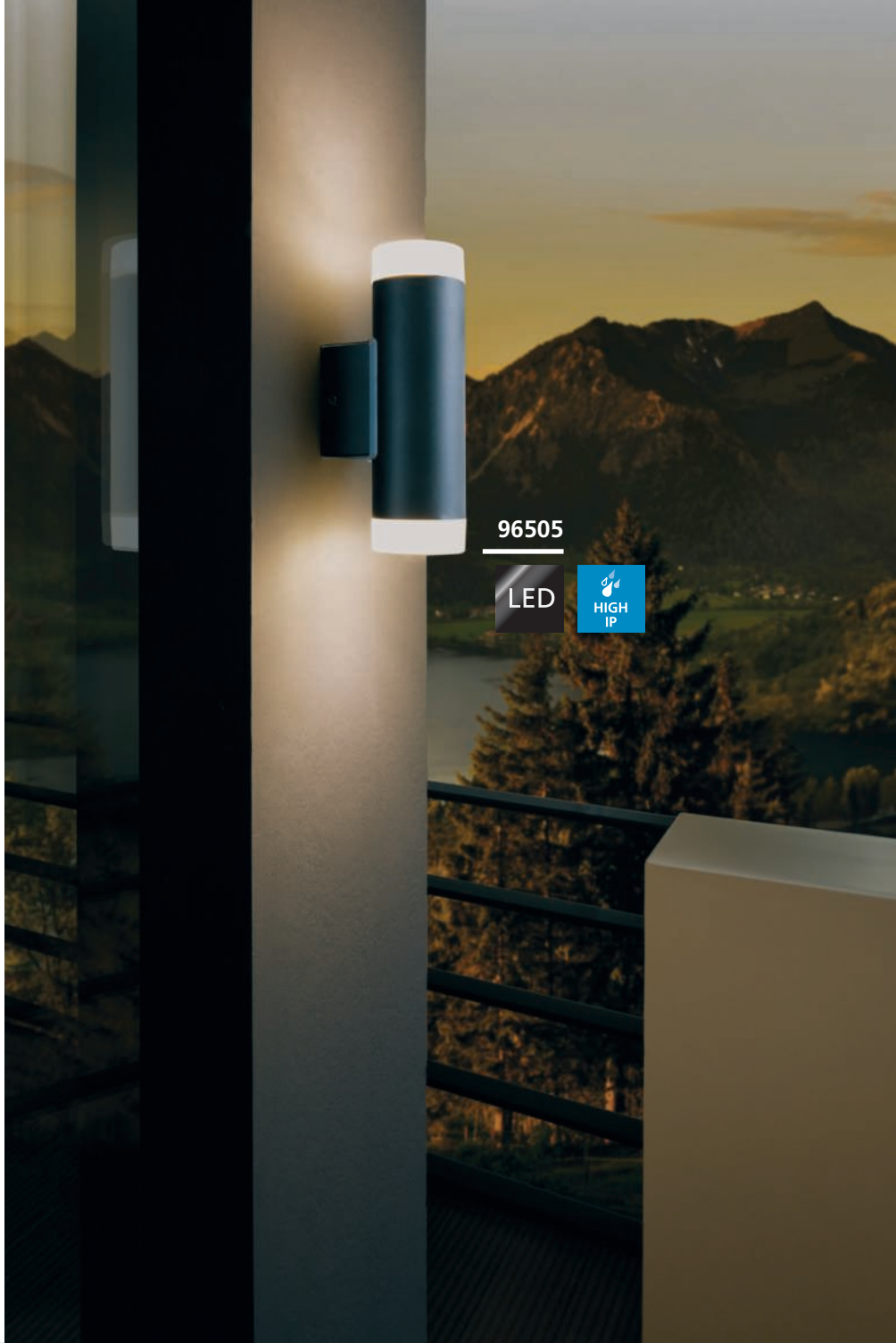

96505



92736 RIGA-LED

wall light; stainless steel, stainless steel / plastic, satin finish
Wandleuchte; Edelstahl, edelstahl / Kunststoff, satiniert
Applique; acier inoxydable, acier inoxydable / plastique, satiné

L 65, H 205, A 95



GU10



2 x

2,8 W



neutral
WHITE

2 x

250 lm



IP54

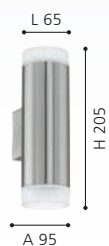

9 002759 927363



96505 RIGA-LED

wall light; zinc-plated steel, black / plastic, satin finish
Wandleuchte; Stahl verzinkt, schwarz / Kunststoff, satiniert
Applique; acier galvanisé, noir / plastique, satiné

L 65, H 205, A 100



GU10



2 x

4,6 W



neutral
WHITE

2 x

400 lm



IP54



9 002759 965051



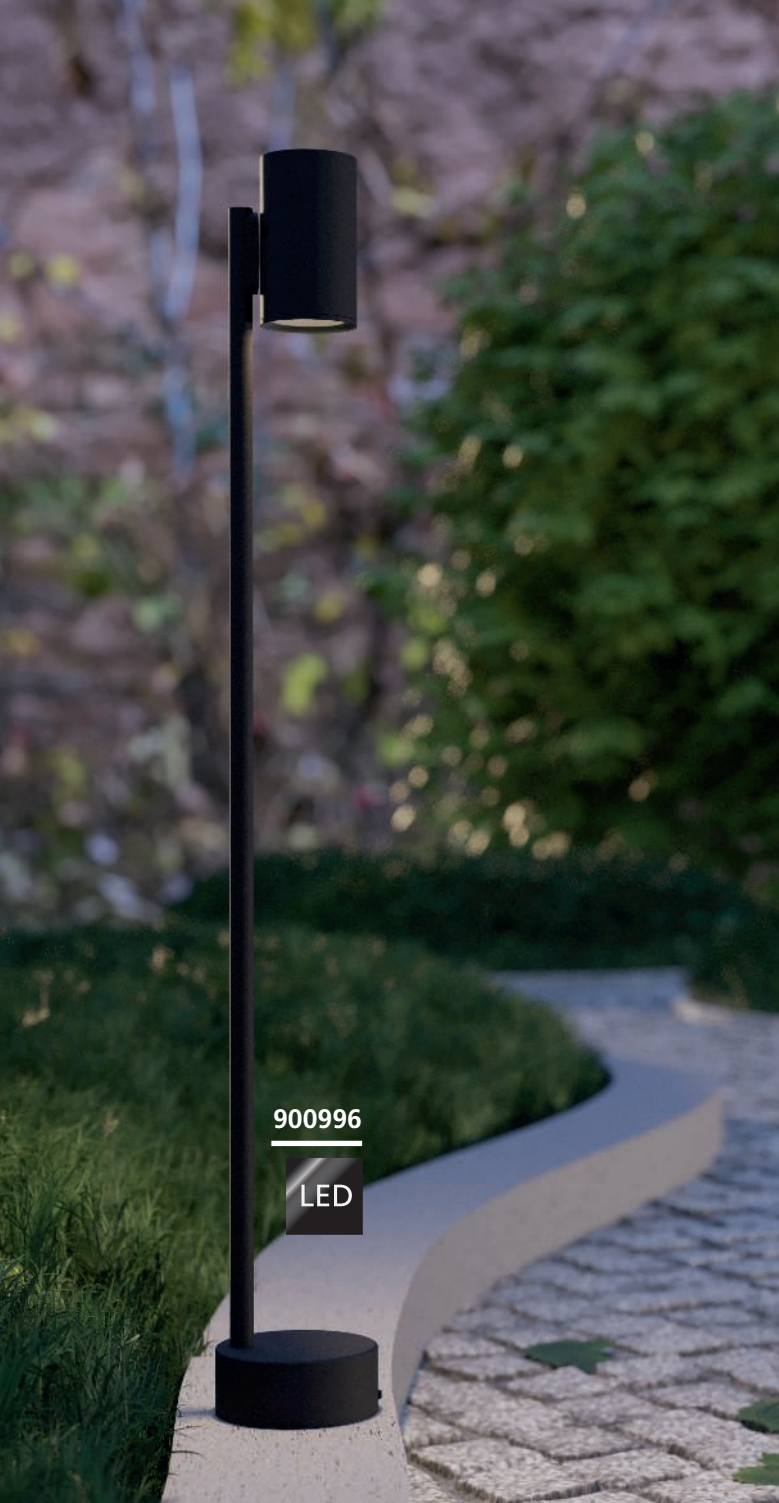

900996

LED



900995

LED



DESIGN
HIGHLIGHT
DETAIL

900996 IZZALINI

floor light; steel, black
Stehleuchte; Stahl, schwarz
lampadaire; acier, noir

L 65, H 850, Base: Ø 110



GU10



1 x
2,8 W



1 x
250 lm



IP44



9 008606 298211



INCL.

900995 IZZALINI

wall light; steel, black
Wandleuchte; Stahl, schwarz
Applique; acier, noir

L 65, H 115, A 95



GU10



1 x
2,8 W



1 x
250 lm



IP44



9 008606 298204



INCL.

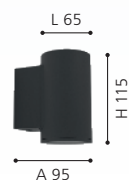



901028



901029



901028 TORRECOLA

ceiling light; aluminium, plastic, black / glass, clear
Deckenleuchte; Alu, Kunststoff, schwarz / Glas, klar
plafonnier; aluminium, plastique, noir / verre, transparent

H 95, Ø 80



GU10



1 x
5 W



IP44



901029 TORRECOLA

ceiling light; aluminium, plastic, black / glass, clear
Deckenleuchte; Alu, Kunststoff, schwarz / Glas, klar
plafonnier; aluminium, plastique, noir / verre, transparent

L 80, B 80, H 95



GU10



1 x
5 W



IP44



9 008606 298136



9 008606 298143





901026



901025



901026 GRUTTI

wall light; aluminium, anthracite / plastic, transparent
Wandleuchte; Alu, anthrazit / Kunststoff, transparent
Applique; aluminium, gris anthracite / plastique, transparent

L 175, H 90, A 50

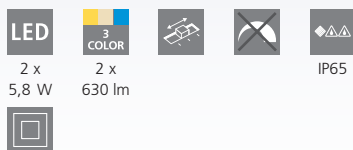

GRUTTI

CCT Dipswitch on the back.
CCT Dip-Schalter auf Rückseite.
CCT Dipwitch à l'arrière.



9 008606 298129



901025 GRUTTI

wall light; aluminium, anthracite / plastic, transparent
Wandleuchte; Alu, anthrazit / Kunststoff, transparent
Applique; aluminium, gris anthracite / plastique, transparent

L 115, H 90, A 50

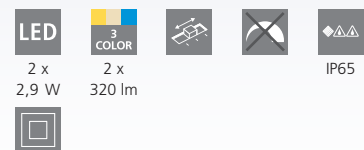

9 008606 298112

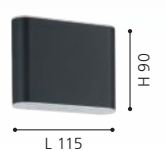



900189



900276



900275



900189 EREMITANA

wall light; zinc-plated steel, black
Wandleuchte; Stahl verzinkt, schwarz
Applique; acier galvanisé, noir

L 110, H 240, A 110

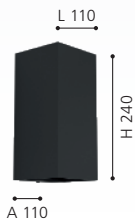
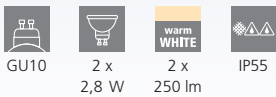

900275 JABAGA

wall light; plastic, black / plastic, transparent
Wandleuchte; Kunststoff, schwarz / Kunststoff, transparent
Applique; plastique, noir / plastique, transparent

L 70, H 80, A 90

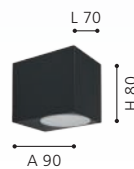

900276 JABAGA

wall light; plastic, black / plastic, transparent
Wandleuchte; Kunststoff, schwarz / Kunststoff, transparent
Applique; plastique, noir / plastique, transparent

L 70, H 155, A 90





900885



900887



900886



900885 SPONGANO

wall light; aluminium, black / glass, clear
Wandleuchte; Alu, schwarz / Glas, klar
Applique; aluminium, noir / verre, transparent

L 185, H 90, A 75



900886 SPONGANO

wall light; aluminium, black / plastic, transparent
Wandleuchte; Alu, schwarz / Kunststoff, transparent
Applique; aluminium, noir / plastique, transparent

L 120, H 200, A 60



900887 SPONGANO

wall light; aluminium, black / plastic, transparent
Wandleuchte; Alu, schwarz / Kunststoff, transparent
Applique; aluminium, noir / plastique, transparent

L 200, H 120, A 60

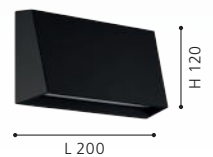



900888



900891



900889



SPONGANO, MARUGGIO

These luminaires can be set via step dimming change the light settings from 3000K, 4000K, 5000K to 6500 Kelvin.

Diese Leuchten können über Stepdimming die Lichteinstellungen von 3000K, 4000K, 5000K zu 6500 Kelvin wechseln.

Ces luminaires peuvent être commandés par stepdimming les réglages de lumière de 3000K, 4000K, 5000K à 6500 Kelvin.

900888 MARUGGIO

wall light; aluminium, black / plastic, transparent
Wandleuchte; Alu, schwarz / Kunststoff, transparent
Applique; aluminium, noir / plastique, transparent

Ø 150, A 35



1 x 4,8 W
1 x 520 lm

900891 MARUGGIO

wall light; aluminium, black / plastic, transparent
Wandleuchte; Alu, schwarz / Kunststoff, transparent
Applique; aluminium, noir / plastique, transparent

L 200, H 90, A 35

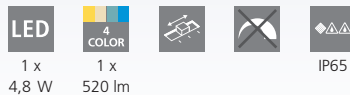

1 x 4,8 W
1 x 520 lm

900889 MARUGGIO

wall light; aluminium, black / plastic, transparent
Wandleuchte; Alu, schwarz / Kunststoff, transparent
Applique; aluminium, noir / plastique, transparent

L 150, H 150, A 35



1 x 4,8 W
1 x 520 lm



9 008606 264018



Ø 150



9 008606 264032



L 200



9 008606 264025



L 150



900445

This wall luminaire creates beautiful stripe pattern on the wall.

Diese Wandleuchten kreieren schöne Streifen an der Wand.

Ces appliques murales créent de belles rayures sur le mur.



900445



97242

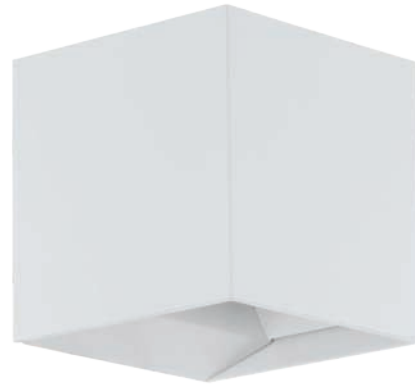

97241



900445 CALPINO 2

wall light; cast aluminium, anthracite
Wandleuchte; Aluguss, anthrazit
Applique; fonte d'aluminium, gris anthracite

L 105, H 105, A 110



2 x 3,3 W
2 x 340 lm



9 008606 253067

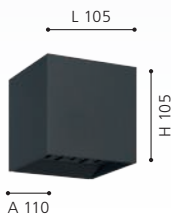

97241 CALPINO

wall light; cast aluminium, white
Wandleuchte; Aluguss, weiss
Applique; fonte d'aluminium, blanc

L 105, H 105, A 110



2 x 3,3 W
2 x 340 lm



9 002759 972417

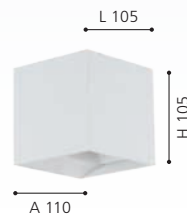

97242 CALPINO

wall light; cast aluminium, anthracite
Wandleuchte; Aluguss, anthrazit
Applique; fonte d'aluminium, gris anthracite

L 105, H 105, A 110



2 x 3,3 W
2 x 340 lm



9 002759 972424

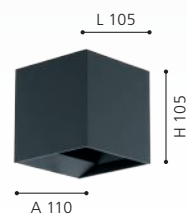



901843



901844



CALPINO, CALPINO 3

These wall luminaires have adjustable flaps.

Diese Wandleuchten besitzen verstellbare Klappen.

Ces luminaires muraux sont dotés d'abatants orientables.

901843 CALPINO 3

wall light; aluminium, white / glass, clear
Wandleuchte; Alu, weiss / Glas, klar
Applique; aluminium, blanc / verre, transparent

L 135, H 100, A 115



2 x 2,8 W
2 x 420 lm



9 008606 347155

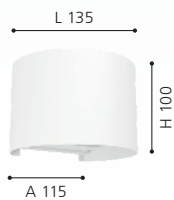

901844 CALPINO 3

wall light; aluminium, black / glass, clear
Wandleuchte; Alu, schwarz / Glas, klar
Applique; aluminium, noir / verre, transparent

L 135, H 100, A 115



2 x 2,8 W
2 x 420 lm



9 008606 347162

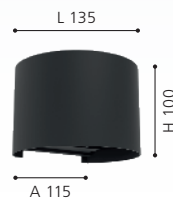



901064



CALPINO 3

The adjustable flaps of the luminaires allow individualised lighting scenarios to be set.

Durch die verstellbaren Klappen der Leuchten können individuell Lichtszenarien eingestellt werden.

Les clapets réglables des luminaires permettent de définir des scénarios d'éclairage individuels.

901064 CALPINO 3

wall light; cast aluminium, black / glass, clear
 Wandleuchte; Aluguss, schwarz / Glas, klar
 Applique; fonte d'aluminium, noir / verre, transparent

L 100, H 100, A 100



2 x
2,8 W



2 x
420 lm



IP54

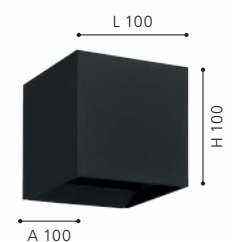



901063



901065

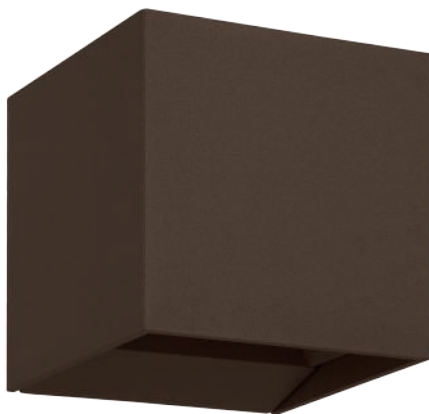

901066



901063 CALPINO 3

wall light; cast aluminium, white / glass, clear
 Wandleuchte; Aluguss, weiss / Glas, klar
 Applique; fonte d'aluminium, blanc / verre, transparent

L 100, H 100, A 100



2 x 2,8 W
 2 x 420 lm

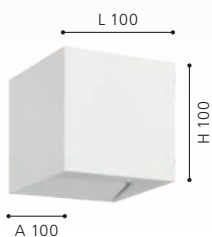

901065 CALPINO 3

wall light; cast aluminium, anthracite / glass, clear
 Wandleuchte; Aluguss, anthrazit / Glas, klar
 Applique; fonte d'aluminium, gris anthracite / verre, transparent

L 100, H 100, A 100



2 x 2,8 W
 2 x 420 lm

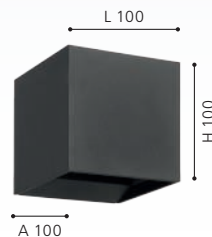

901066 CALPINO 3

wall light; cast aluminium, auburn / glass, clear
 Wandleuchte; Aluguss, rostbraun / Glas, klar
 Applique; fonte d'aluminium, brun rouille / verre, transparent

L 100, H 100, A 100



2 x 2,8 W
 2 x 420 lm

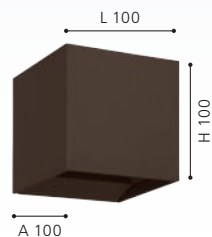



96287

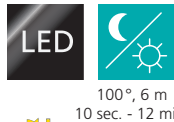

SAFETY & COMFORT



SAKEDA

The front panel of the luminaires can be swiveled. Thus, the light pattern can be adjusted individually.

Die Frontplatte der Leuchten ist schwenkbar. Somit kann das Lichtbild individuell eingestellt werden.

La plaque frontale des luminaires est orientable. Ainsi, l'image lumineuse peut être réglée individuellement.



96256



96287 SAKEDA

wall light; cast aluminium, anthracite
Wandleuchte; Aluguss, anthrazit
Applique; fonte d'aluminium, gris anthracite

96256 JORBA

wall light; cast aluminium, anthracite / plastic, white
Wandleuchte; Aluguss, anthrazit / Kunststoff, weiss
Applique; fonte d'aluminium, gris anthracite / plastique, blanc

95097 DESELLA 1

wall light; cast aluminium, anthracite / plastic, white
Wandleuchte; Aluguss, anthrazit / Kunststoff, weiss
Applique; fonte d'aluminium, gris anthracite / plastique, blanc

L 70, H 170, A 100



1 x 5 W
1 x 600 lm

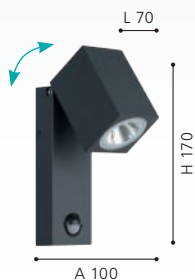

L 110, H 110, A 110



1 x 4,9 W
1 x 360 lm

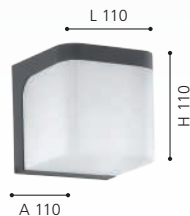

L 160, H 160, A 190



1 x 10 W
1 x 1200 lm

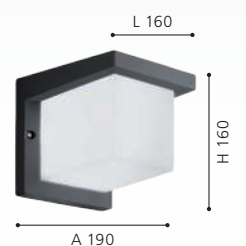

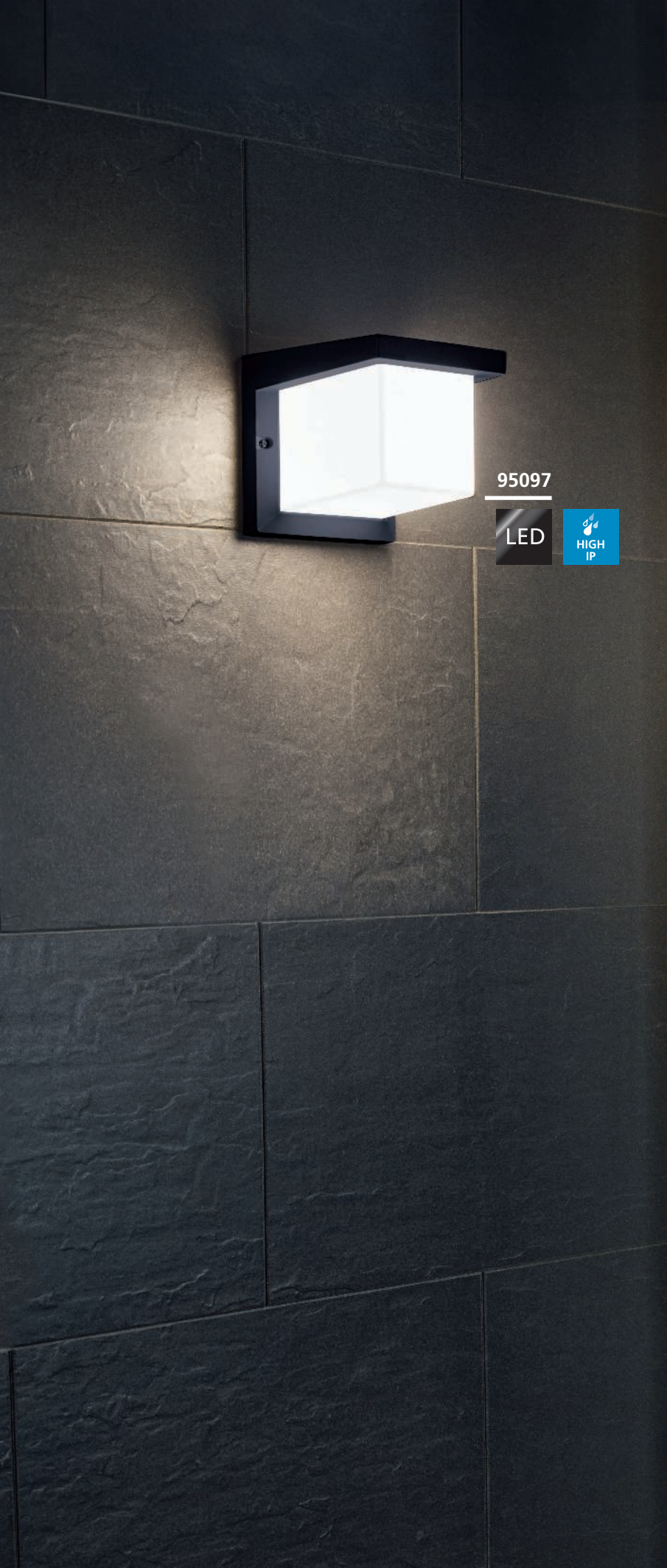

95097

LED

HIGH
IP





900807

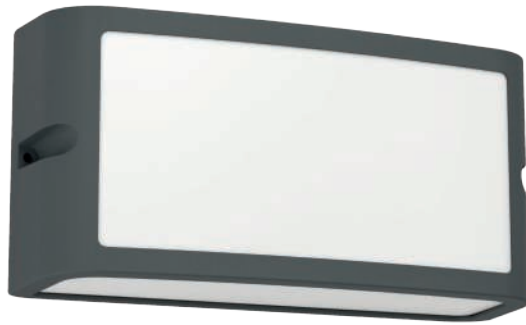

900808



900809



900807 CAMARDA

wall light; aluminium, white / plastic, white
Wandleuchte; Alu, weiss / Kunststoff, weiss
Applique; aluminium, blanc / plastique, blanc

L 220, H 110, A 90

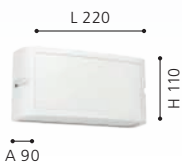

900808 CAMARDA

wall light; aluminium, anthracite / plastic, white
Wandleuchte; Alu, anthrazit / Kunststoff, weiss
Applique; aluminium, gris anthracite / plastique, blanc

L 220, H 110, A 90

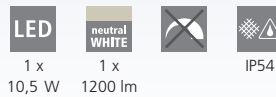

900809 CAMARDA

wall light; aluminium, white / plastic, white
Wandleuchte; Alu, weiss / Kunststoff, weiss
Applique; aluminium, blanc / plastique, blanc

L 220, H 110, A 90

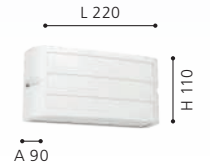
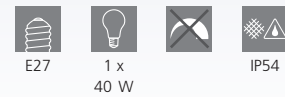



900811



900811 CAMARDA

wall light; aluminium, anthracite / plastic, white
Wandleuchte; Alu, anthrazit / Kunststoff, weiss
Applique; aluminium, gris anthracite / plastique, blanc

L 220, H 110, A 90



E27



1 x
40 W



IP54



9 008606 261925

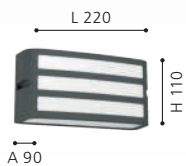



96018



90°, 6 m
10 sec. - 10 min.

SAFETY &
COMFORT



83433



97284



180°, 6 m
10 sec. - 15 min.

SAFETY & COMFORT

96018 BREGANZO 1

wall light; zinc-plated steel, anthracite / plastic, white
Wandleuchte; Stahl verzinkt, anthrazit / Kunststoff, weiss
Applique; acier galvanisé, gris anthracite / plastique, blanc

L 190, H 300, A 125



2 x
2,5 W
2 x
230 lm



83433 PARK

wall light; cast aluminium, anthracite / satin glass, white
Wandleuchte; Aluguss, anthrazit / Glas satiniert, weiss
Applique; fonte d'aluminium, gris anthracite / verre satiné, blanc

L 200, H 350, A 145



E27
1 x
60 W
IP44



97284 TRIBANO

wall light; zinc-plated steel, stainless steel / plastic, transparent
Wandleuchte; Stahl verzinkt, edelstahl / Kunststoff, transparent
Applique; acier galvanisé, acier inoxydable / plastique, transparent

L 200, H 260, A 100



E27
1 x
60 W
IP44





93268

LED



30191

93268 STOCKHOLM 1

wall light; stainless steel, stainless steel / glass, clear
Wandleuchte; Edelstahl, edelstahl / Glas, klar
Applique; acier inoxydable, acier inoxydable / verre, transparent

Ø 100



GU10



1 x
4,6 W



1 x
400 lm



IP44



9 002759 932688



INCL.



Ø 100

30191 CERNO

wall light; stainless steel, stainless steel / satin glass, white
Wandleuchte; Edelstahl, edelstahl / Glas satiniert, weiss
Applique; acier inoxydable, acier inoxydable / verre satiné, blanc

L 140, H 165, A 105



E27



1 x
40 W



IP44



9 002759 301910





30192



90°, 7 m
10 sec. - 4 min.

**SAFETY &
COMFORT**



99565



99566



90°, 6 m
5 sec. - 5 min.

**SAFETY &
COMFORT**

30192 CERNO

wall light; stainless steel, stainless steel / satin glass, white
Wandleuchte; Edelstahl, edelstahl / Glas satiniert, weiss
Applique; acier inoxydable, acier inoxydable / verre satiné, blanc

L 140, H 190, A 110



E27



1 x
40 W



IP44



9 002759 301927

99565 CERNO

wall light; zinc-plated steel, black / satin glass, white
Wandleuchte; Stahl verzinkt, schwarz / Glas satiniert, weiss
Applique; acier galvanisé, noir / verre satiné, blanc

L 140, H 165, A 105



E27



1 x
40 W



IP44

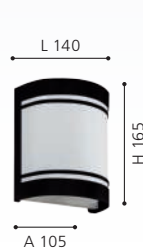

9 002759 995652

99566 CERNO

wall light; zinc-plated steel, black / satin glass, white
Wandleuchte; Stahl verzinkt, schwarz / Glas satiniert, weiss
Applique; acier galvanisé, noir / verre satiné, blanc

L 140, H 200, A 110



E27



1 x
40 W



IP44



9 002759 995669



88144



90°, 7 m
10 sec. - 5 min.

**SAFETY &
COMFORT**



82309



88142



90°, 7 m
10 sec. - 5 min.

**SAFETY &
COMFORT**

88144 CITY

wall light; stainless steel, stainless steel / plastic, white
Wandleuchte; Edelstahl, edelstahl / Kunststoff, weiss
Applique; acier inoxydable, acier inoxydable / plastique, blanc

82309 CITY

wall light; stainless steel, stainless steel / plastic, white
Wandleuchte; Edelstahl, edelstahl / Kunststoff, weiss
Applique; acier inoxydable, acier inoxydable / plastique, blanc

88142 CITY

wall light; stainless steel, stainless steel / plastic, white
Wandleuchte; Edelstahl, edelstahl / Kunststoff, weiss
Applique; acier inoxydable, acier inoxydable / plastique, blanc

L 235, H 260, A 90



E27



1 x
60 W



IP44



L 235



A 90



9 002759 881443

L 235, H 260, A 90



E27



1 x
60 W



IP44



L 235



A 90



9 002759 823092

L 235, H 260, A 90



E27



1 x
60 W



IP44



L 235



A 90



9 002759 881429



88139



99568



90°, 7 m
10 sec. - 5 min.

**SAFETY &
COMFORT**



99567

88139 CITY

wall light; stainless steel, stainless steel / plastic, white
Wandleuchte; Edelstahl, edelstahl / Kunststoff, weiss
Applique; acier inoxydable, acier inoxydable / plastique, blanc

L 235, H 260, A 90



E27



1 x
60 W



IP44



L 235

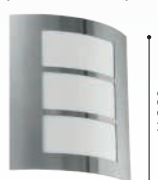

A 90



9 002759 881399

99568 CITY

wall light; zinc-plated steel, black / plastic, white
Wandleuchte; Stahl verzinkt, schwarz / Kunststoff, weiss
Applique; acier galvanisé, noir / plastique, blanc

L 235, H 260, A 110



E27



1 x
40 W



IP44



L 235



A 110



9 002759 995683

99567 CITY

wall light; zinc-plated steel, black / plastic, white
Wandleuchte; Stahl verzinkt, schwarz / Kunststoff, weiss
Applique; acier galvanisé, noir / plastique, blanc

L 235, H 260, A 90



E27



1 x
40 W



IP44



L 235



A 90



9 002759 995676



900278

LED



900281

LED

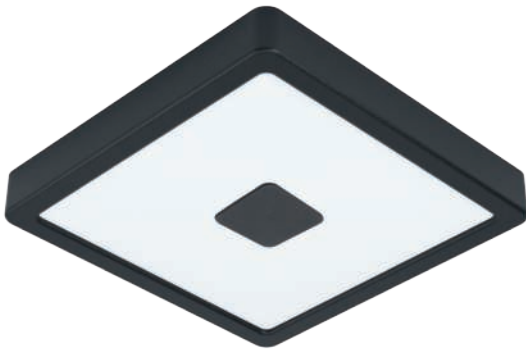

900283

LED

900278 ARGOLIS 2

surface-mounted light; steel, black / plastic, white
Aufbauleuchte; Stahl, schwarz / Kunststoff, weiss
luminaire en saillie; acier, noir / plastique, blanc

H 30, Ø 285



1 x 20,5 W
1 x 2400 lm



9 008606 232635



900281 ARGOLIS 2

surface-mounted light; steel, black / plastic, white
Aufbauleuchte; Stahl, schwarz / Kunststoff, weiss
luminaire en saillie; acier, noir / plastique, blanc

L 285, B 285, H 30



1 x 20,5 W
1 x 2400 lm



9 008606 232659



900283 IPHIAS 2

surface-mounted light; steel, black / plastic, white
Aufbauleuchte; Stahl, schwarz / Kunststoff, weiss
luminaire en saillie; acier, noir / plastique, blanc

L 210, B 210, H 30



1 x 17 W
1 x 2000 lm



9 008606 232611

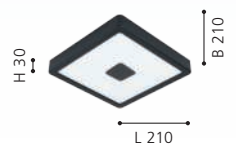



900277



900279



900277 ARGOLIS 2

surface-mounted light; steel, white / plastic, white
Aufbauleuchte; Stahl, weiss / Kunststoff, weiss
luminaire en saillie; acier, blanc / plastique, blanc

H 30, Ø 285



1 x
20,5 W



1 x
2400 lm



IP44



900279 ARGOLIS 2

surface-mounted light; steel, white / plastic, white
Aufbauleuchte; Stahl, weiss / Kunststoff, weiss
luminaire en saillie; acier, blanc / plastique, blanc

L 285, B 285, H 30



1 x
20,5 W



1 x
2400 lm



IP44



9 008606 232628

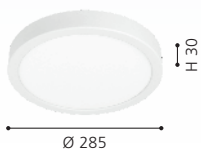

9 008606 232642





901524



901525



901526



901524 APPRODO

wall/ceiling light; steel, white / plastic, white
Wand- / Deckenleuchte; Stahl, weiss / Kunststoff, weiss
Applique/Plafonnier; acier, blanc / plastique, blanc

H 55, Ø 260



1 x 12 W
1 x 1600 lm



9 008606 313143

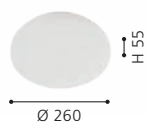

901525 APPRODO

wall/ceiling light; steel, white / plastic, white
Wand- / Deckenleuchte; Stahl, weiss / Kunststoff, weiss
Applique/Plafonnier; acier, blanc / plastique, blanc

H 55, Ø 310

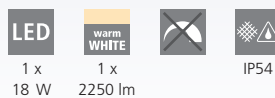

1 x 18 W
1 x 2250 lm



9 008606 313150

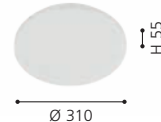

901526 APPRODO

wall/ceiling light; steel, white / plastic, white
Wand- / Deckenleuchte; Stahl, weiss / Kunststoff, weiss
Applique/Plafonnier; acier, blanc / plastique, blanc

H 70, Ø 430



1 x 36 W
1 x 4600 lm



9 008606 313167

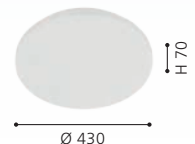



901527



360°, 1 m
5 sec. - 3 min.



901528



901529



901527 APPRODO

wall/ceiling light; steel, white / plastic, white
Wand- / Deckenleuchte; Stahl, weiss / Kunststoff, weiss
Applique/Plafonnier; acier, blanc / plastique, blanc

H 55, Ø 310

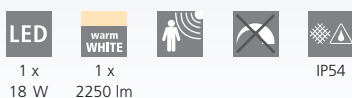

1 x 18 W
1 x 2250 lm

901528 MARGIDORE

wall/ceiling light; steel, white / plastic, white, satin nickel
Wand- / Deckenleuchte; Stahl, weiss / Kunststoff, weiss, nickel-matt
Applique/Plafonnier; acier, blanc / plastique, blanc, nickel mat

H 65, Ø 340

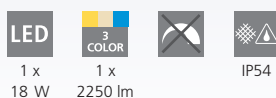

1 x 18 W
1 x 2250 lm

901529 MARGIDORE

wall/ceiling light; steel, white / plastic, white, black
Wand- / Deckenleuchte; Stahl, weiss / Kunststoff, weiss, schwarz
Applique/Plafonnier; acier, blanc / plastique, blanc, noir

H 65, Ø 340

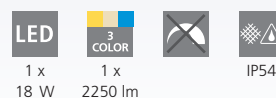

1 x 18 W
1 x 2250 lm



9 008606 313174

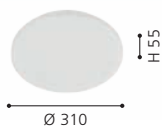

9 008606 313181



9 008606 313198





901572



901573



901574



901572 MINERARIO

ceiling light; plastic, black / plastic, white
Deckenleuchte; Kunststoff, schwarz / Kunststoff, weiss
plafonnier; plastique, noir / plastique, blanc

H 30, Ø 300



1 x 16,4 W
1 x 2500 lm



9 008606 313563



901573 MINERARIO

ceiling light; plastic, black / plastic, white
Deckenleuchte; Kunststoff, schwarz / Kunststoff, weiss
plafonnier; plastique, noir / plastique, blanc

H 30, Ø 390



1 x 20,2 W
1 x 3200 lm



9 008606 313570

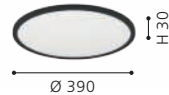

901574 MINERARIO

ceiling light; plastic, black / plastic, white
Deckenleuchte; Kunststoff, schwarz / Kunststoff, weiss
plafonnier; plastique, noir / plastique, blanc

L 290, B 290, H 30



1 x 16,4 W
1 x 2400 lm



9 008606 313587





901575



901575 MINERARIO

ceiling light; plastic, black / plastic, white
Deckenleuchte; Kunststoff, schwarz / Kunststoff, weiss
plafonnier; plastique, noir / plastique, blanc

L 390, B 390, H 30



1 x
20,4 W



1 x
3000 lm



IP54



9 008606 313594

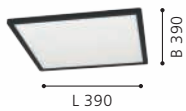



901576



901576 MINERARIO

ceiling light; plastic, white / plastic, white
Deckenleuchte; Kunststoff, weiss / Kunststoff, weiss
plafonnier; plastique, blanc / plastique, blanc

H 30, Ø 300



1 x
16,4 W



1 x
2500 lm



IP54



9 008606 313600

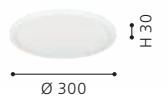



901577



901578



901579



901577 MINERARIO

ceiling light; plastic, white / plastic, white
Deckenleuchte; Kunststoff, weiss / Kunststoff, weiss
plafonnier; plastique, blanc / plastique, blanc

H 30, Ø 390



1 x
20,2 W

1 x
3200 lm

901578 MINERARIO

ceiling light; plastic, white / plastic, white
Deckenleuchte; Kunststoff, weiss / Kunststoff, weiss
plafonnier; plastique, blanc / plastique, blanc

L 290, B 290, H 30



1 x
16,4 W

1 x
2400 lm

901579 MINERARIO

ceiling light; plastic, white / plastic, white
Deckenleuchte; Kunststoff, weiss / Kunststoff, weiss
plafonnier; plastique, blanc / plastique, blanc

L 390, B 390, H 30



1 x
20,4 W

1 x
3000 lm



9 008606 313617



9 008606 313624

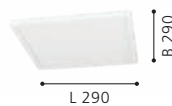

9 008606 313631





901531



CASTAGNETO

Mounting plate is available separately.

Montageplatte ist separat erhältlich.

La plaque de montage est disponible séparément.



901532



901533



901531 CASTAGNETO

ceiling light; plastic, white
Deckenleuchte; Kunststoff, weiss
plafonnier; plastique, blanc

H 50, Ø 260

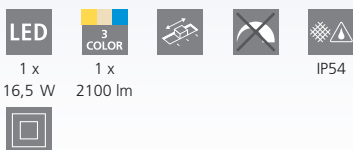

1 x 16,5 W
1 x 2100 lm



9 008606 313204

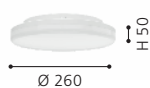

901532 CASTAGNETO

ceiling light; plastic, white
Deckenleuchte; Kunststoff, weiss
plafonnier; plastique, blanc

H 50, Ø 310

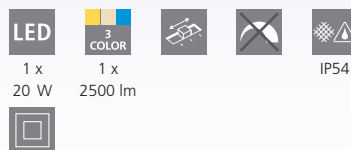

1 x 20 W
1 x 2500 lm



9 008606 313211



901533 CASTAGNETO

ceiling light; plastic, white
Deckenleuchte; Kunststoff, weiss
plafonnier; plastique, blanc

L 260, B 260, H 50

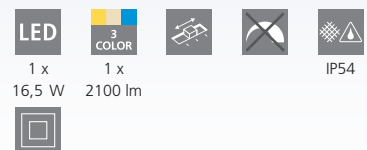

1 x 16,5 W
1 x 2100 lm



9 008606 313228

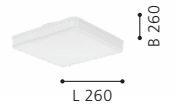



901534



901535



901536

901534 CASTAGNETO

ceiling light; plastic, white
Deckenleuchte; Kunststoff, weiss
plafonnier; plastique, blanc

L 310, B 310, H 50

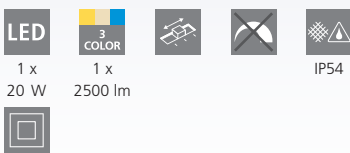

1 x 20 W
1 x 2500 lm

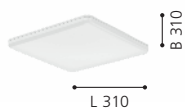

901535 CASTAGNETO

ceiling light; plastic, white
Deckenleuchte; Kunststoff, weiss
plafonnier; plastique, blanc

H 50, Ø 310

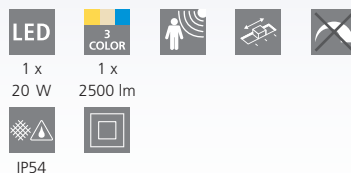

1 x 20 W
1 x 2500 lm



901536 CASTAGNETO-M

accessory; plastic, white
Zubehör; Kunststoff, weiss
Accessoires; plastique, blanc

H 20, Ø 200





94871

LED



94872

LED



DAY &
NIGHT
Sensor

97289

LED



SAFETY &
COMFORT

3x 0-9 1x a-f

97289

Letters and numbers included in delivery.

Buchstaben und Zahlen im Lieferumfang enthalten.

Les lettres et les nombres sont inclus dans la livraison.

94871 SONELLA

wall/ceiling light; plastic, white / plastic, white
Wand- / Deckenleuchte; Kunststoff, weiss / Kunststoff, weiss
Applique/Plafonnier; plastique, blanc / plastique, blanc

L 215, H 215, A 70



1 x 8,2 W 1 x 1000 lm



9 002759 948719

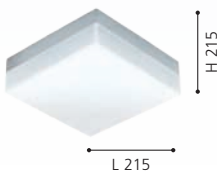

94872 SONELLA

wall/ceiling light; plastic, anthracite / plastic, white
Wand- / Deckenleuchte; Kunststoff, anthrazit / Kunststoff, weiss
Applique/Plafonnier; plastique, gris anthracite / plastique, blanc

L 215, H 215, A 70



1 x 8,2 W 1 x 1000 lm



9 002759 948726

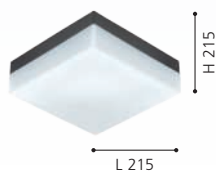

97289 CORNALE

wall light; plastic, anthracite / plastic, white
Wandleuchte; Kunststoff, anthrazit / Kunststoff, weiss
Applique; plastique, gris anthracite / plastique, blanc

L 215, H 215, A 70

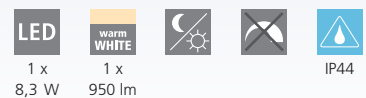

1 x 8,3 W 1 x 950 lm



9 002759 972899





94121



96365



96365 VENTO 2

wall/ceiling light; stainless steel, stainless steel / plastic, white
Wand- / Deckenleuchte; Edelstahl, edelstahl / Kunststoff, weiss
Applique/Plafonnier; acier inoxydable, acier inoxydable /
plastique, blanc

Ø 185, A 70



1 x
5,4 W



1 x
450 lm



IP44

94121 VENTO 1

wall/ceiling light; stainless steel, stainless steel / glass, white
painted
Wand- / Deckenleuchte; Edelstahl, edelstahl / Glas, weiss lackiert
Applique/Plafonnier; acier inoxydable, acier inoxydable / verre,
blanc laqué

Ø 285, A 80



1 x
11 W



1 x
1300 lm



IP44



9 002759 963651



Ø 185



9 002759 941215



Ø 285



99584



120°, 6 m
5 sec. - 10 min.

**SAFETY &
COMFORT**



99584 MADRIZ

wall light; cast aluminium, black / plastic, white
Wandleuchte; Aluguss, schwarz / Kunststoff, weiss
Applique; fonte d'aluminium, noir / plastique, blanc

L 230, H 190, A 50



2 x
3,6 W



2 x
370 lm



IP44



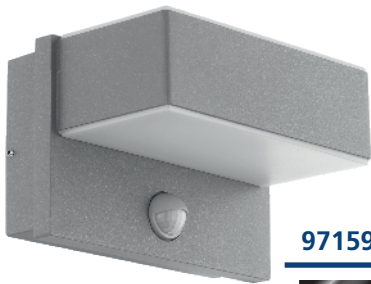

97159

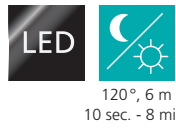

SAFETY & COMFORT



97218

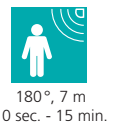

SAFETY & COMFORT



97238

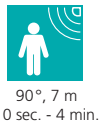

SAFETY & COMFORT

97159 AZZINANO

wall light; zinc-plated steel, silver / plastic, white
Wandleuchte; Stahl verzinkt, silber / Kunststoff, weiss
Applique; acier galvanisé, argent / plastique, blanc

L 185, H 115, A 125

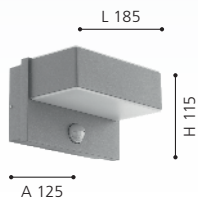
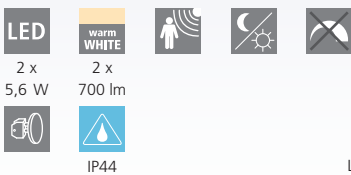

97218 MUSSOTTO

wall light; stainless steel, plastic, stainless steel, white / plastic, white
Wandleuchte; Edelstahl, Kunststoff, edelstahl, weiss / Kunststoff, weiss

Applique; acier inoxydable, plastique, acier inoxydable, blanc / plastique, blanc
L 210, H 305, A 90



97238 VERRES

wall light; stainless steel, plastic, stainless steel, white / plastic, white
Wandleuchte; Edelstahl, Kunststoff, edelstahl, weiss / Kunststoff, weiss

Applique; acier inoxydable, plastique, acier inoxydable, blanc / plastique, blanc
L 180, H 290, A 90





98731

99586 & 99598

These luminaires can be mounted upwards or downwards.

Diese Leuchten können aufwärts oder abwärts montiert werden.

Ces luminaires peut être montée vers le haut ou vers le bas.



1



99598



2

98731 PRATA VECCHIA

wall light; zinc-plated steel, black / plastic, white
Wandleuchte; Stahl verzinkt, schwarz / Kunststoff, weiss
Applique; acier galvanisé, noir / plastique, blanc

L 200, H 260, A 285

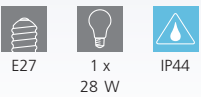

9 002759 987312



99598 TAVERNA

wall light; zinc-plated steel, black / plastic, transparent
Wandleuchte; Stahl verzinkt, schwarz / Kunststoff, transparent
Applique; acier galvanisé, noir / plastique, transparent

L 200, H 230, A 270

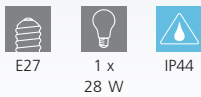

9 002759 995980



99586 TAVERNA

wall light; zinc-plated steel, black / plastic, black-transparent
Wandleuchte; Stahl verzinkt, schwarz / Kunststoff, schwarz-transparent
Applique; acier galvanisé, noir / plastique, noir transparent

L 200, H 230, A 255

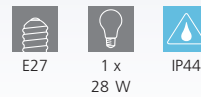

9 002759 995867





99586





98101

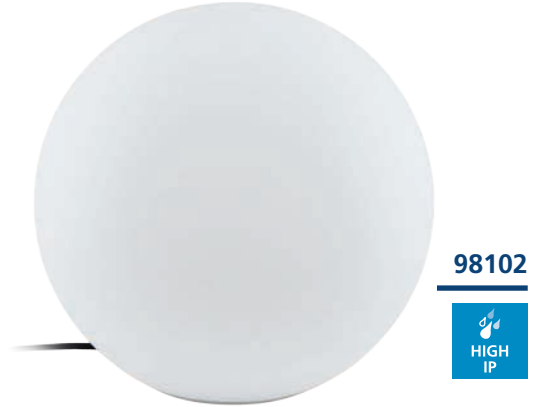

98102



98103



98101 MONTEROLO

floor light; plastic, white / plastic, white
 Stehleuchte; Kunststoff, weiss / Kunststoff, weiss
 lampadaire; plastique, blanc / plastique, blanc

H 300, Ø 300, Base: Ø 120

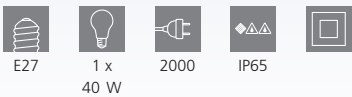

9 002759 981013

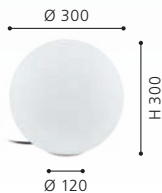

98102 MONTEROLO

floor light; plastic, white / plastic, white
 Stehleuchte; Kunststoff, weiss / Kunststoff, weiss
 lampadaire; plastique, blanc / plastique, blanc

H 390, Ø 390, Base: Ø 195

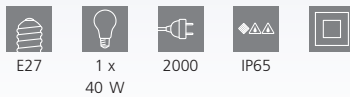

9 002759 981020



98103 MONTEROLO

floor light; plastic, white / plastic, white
 Stehleuchte; Kunststoff, weiss / Kunststoff, weiss
 lampadaire; plastique, blanc / plastique, blanc

H 500, Ø 500, Base: Ø 195

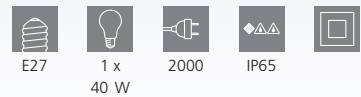

9 002759 981037

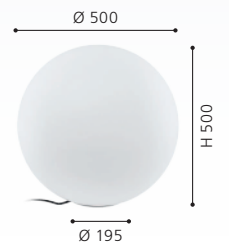



902042



902043



902042 ZANCARO

ground spike; aluminium, black / plastic, white
 Erdspieß; Alu, schwarz / Kunststoff, weiss
 piquet de terre; aluminium, noir / plastique, blanc

H 600, Ø 30

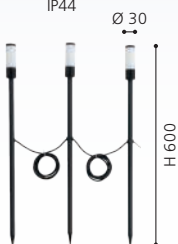
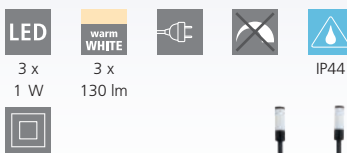

902043 ZANCARO 1

ground spike; aluminium, black / plastic, white
 Erdspieß; Alu, schwarz / Kunststoff, weiss
 piquet de terre; aluminium, noir / plastique, blanc

H 600, Ø 30

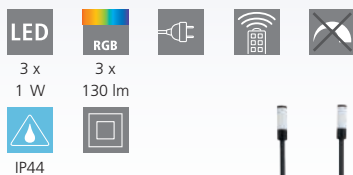



TRADITIONAL

TRADITIONELL
TRADITIONNELLE



EN **TRADITIONAL ELEGANCE**

Romantic elements made of different materials create an inviting atmosphere that brings the beauty of the past into your surroundings.

DE **TRADITIONELLE ELEGANZ**

Romantische Elemente aus unterschiedlichen Materialien schaffen eine einladende Atmosphäre, die die Schönheit der Vergangenheit in Ihre Umgebung bringt.

FR **ÉLÉGANCE TRADITIONNELLE**

Des éléments romantiques composés de différents matériaux créent une atmosphère accueillante qui apporte la beauté du passé dans votre environnement.





OVERVIEW

TRADITIONAL
TRADITIONELL
TRADITIONNELLE



SIRMIONE
150



SIDNEY
151



LISIO
152



CARRARO
154



BOVOLONE
155



DONATORI
155



SONCINO
156



TRECATE
156



MIRANDOLA
156



VALDEO
157, 161



HILBURN
157



HILBURN 1
157



CANOVE
159



MILTON
159



MELGOA
160



SAN TELMO
160



PULFERO 1
161



ALBACETE
161



ALORIA
162-163



NAVEDO
164-169



LATERNA 4
170-172



LATERNA 5
174-175



ONJA
176

 This product is available in different colors and shapes. / Dieser Artikel ist in unterschiedlichen Farben und Formen verfügbar. / Cet article est disponible en différentes couleurs et formes.





97287

97285



97288

97285 SIRMIONE

wall light; zinc-plated steel, black, gold / matte-opal glass, white
Wandleuchte; Stahl verzinkt, schwarz, gold / Glas opal-matt, weiss
Applique; acier galvanisé, noir, or / verre opale mat, blanc

L 270, H 375, A 330

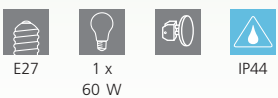

97287 SIRMIONE

floor light; zinc-plated steel, black, gold / matte-opal glass, white
Stehleuchte; Stahl verzinkt, schwarz, gold / Glas opal-matt, weiss
lampadaire; acier galvanisé, noir, or / verre opale mat, blanc

L 340, B 270, H 1200, Base: Ø 110

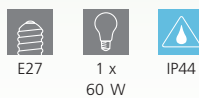

97288 SIRMIONE

floor light; zinc-plated steel, black, gold / matte-opal glass, white
Stehleuchte; Stahl verzinkt, schwarz, gold / Glas opal-matt, weiss
lampadaire; acier galvanisé, noir, or / verre opale mat, blanc

H 2200, Ø 550, Base: Ø 200

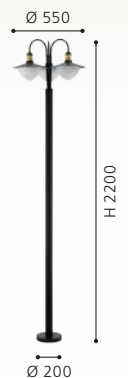
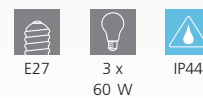



83966



87105



120°, 6 m
5 sec. - 8 min.

**SAFETY &
COMFORT**

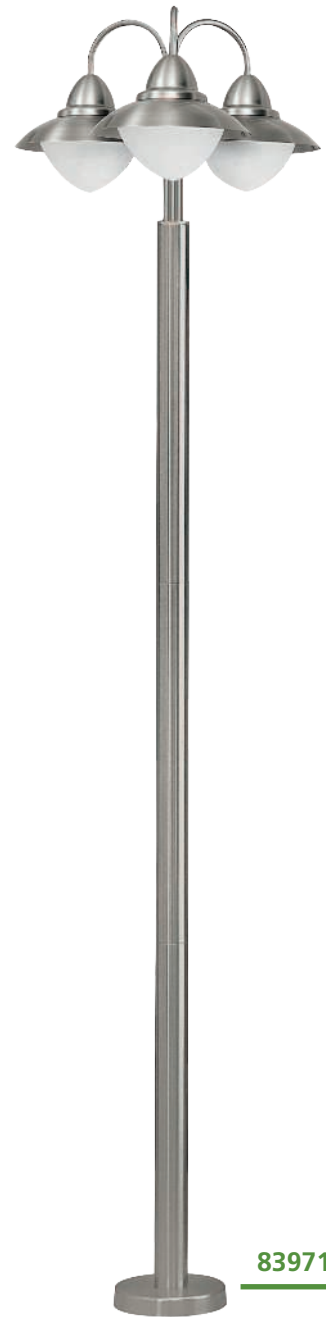

83971

83966 SIDNEY

wall light; stainless steel, stainless steel / matte-opal glass, white
Wandleuchte; Edelstahl, edelstahl / Glas opal-matt, weiss
Applique; acier inoxydable, acier inoxydable / verre opale mat, blanc

H 375, Ø 270, A 325



E27



1 x
60 W



IP44



9 002759 839666

87105 SIDNEY

wall light; stainless steel, stainless steel / matte-opal glass, white
Wandleuchte; Edelstahl, edelstahl / Glas opal-matt, weiss
Applique; acier inoxydable, acier inoxydable / verre opale mat, blanc

H 375, Ø 270, A 325



E27



1 x
60 W



IP44



9 002759 871055

83971 SIDNEY

floor light; stainless steel, stainless steel / matte-opal glass, white
Stehleuchte; Edelstahl, edelstahl / Glas opal-matt, weiss
lampadaire; acier inoxydable, acier inoxydable / verre opale mat, blanc

H 2200, Ø 600, Base: Ø 200



E27



3 x
60 W



IP44

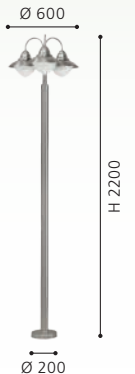

9 002759 839710



30184

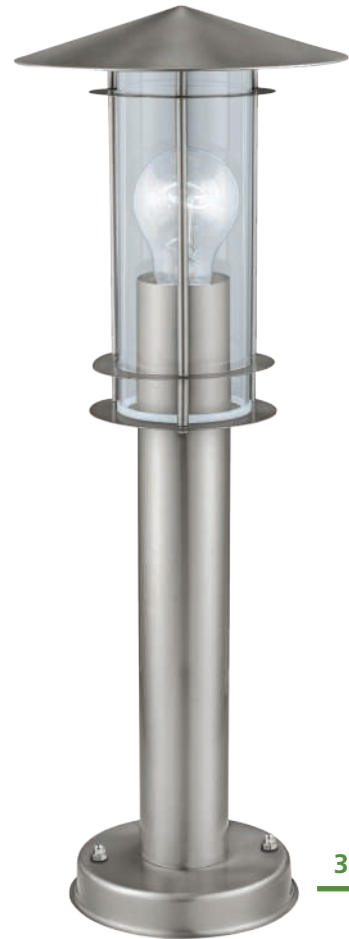

30187

30184 LISIO

wall light; stainless steel, stainless steel / glass, clear
 Wandleuchte; Edelstahl, edelstahl / Glas, klar
 Applique; acier inoxydable, acier inoxydable / verre, transparent

L 175, H 300, A 225

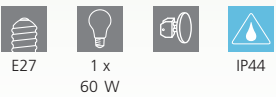

9 002759 301842

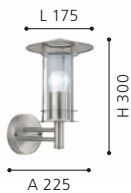

30187 LISIO

floor light; stainless steel, stainless steel / glass, clear
 Stehleuchte; Edelstahl, edelstahl / Glas, klar
 lampadaire; acier inoxydable, acier inoxydable / verre, transparent

H 500, Ø 175, Base: Ø 130

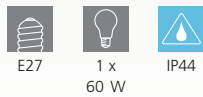

9 002759 301873



30185 LISIO

wall light; stainless steel, stainless steel / glass, clear
 Wandleuchte; Edelstahl, edelstahl / Glas, klar
 Applique; acier inoxydable, acier inoxydable / verre, transparent

L 175, H 360, A 225



9 002759 301859





30185



90°, 8 m
10 sec. - 4 min.

**SAFETY &
COMFORT**



900285



900286

DESIGN
HIGHLIGHT
DETAIL



900285 CARRARO

wall light; steel, black / glass, clear
Wandleuchte; Stahl, schwarz / Glas, klar
Applique; acier, noir / verre, transparent

L 115, H 380, A 130



E27



1 x
28 W



IP44



9 008606 231577



900286 CARRARO

wall light; steel, grey, black / glass, clear
Wandleuchte; Stahl, grau, schwarz / Glas, klar
Applique; acier, gris, noir / verre, transparent

L 115, H 380, A 130



E27



1 x
28 W



IP44



9 008606 231584





97261



98701

97261 BOVOLONE

wall light; zinc-plated steel, black / glass, clear
Wandleuchte; Stahl verzinkt, schwarz / Glas, klar
Applique; acier galvanisé, noir / verre, transparent

L 110, H 340, A 155



E27



1 x
60 W



IP44



9 002759 972615

98701 DONATORI

wall light; aluminium, plastic, black / glass, clear
Wandleuchte; Alu, Kunststoff, schwarz / Glas, klar
Applique; aluminium, plastique, noir / verre, transparent

L 155, H 260, A 190



E27



1 x
60 W



IP44



9 002759 987015



97294



97296



98719

97294 SONCINO

wall light; cast aluminium, black / glass, clear
Wandleuchte; Aluguss, schwarz / Glas, klar
Applique; fonte d'aluminium, noir / verre, transparent

97296 TRECATE

wall light; zinc-plated steel, black / glass, clear
Wandleuchte; Stahl verzinkt, schwarz / Glas, klar
Applique; acier galvanisé, noir / verre, transparent

98719 MIRANDOLA

wall light; cast aluminium, black / glass, clear
Wandleuchte; Aluguss, schwarz / Glas, klar
Applique; fonte d'aluminium, noir / verre, transparent

L 265, H 330, A 120

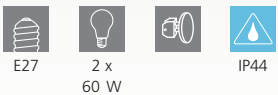

9 002759 972943



L 160, H 355, A 130



9 002759 972967



L 180, H 270, A 225



9 002759 987190





96239



94843



94866

96239 VALDEO

wall light; zinc-plated steel, black / glass, clear
Wandleuchte; Stahl verzinkt, schwarz / Glas, klar
Applique; acier galvanisé, noir / verre, transparent

L 165, H 275, A 200



E27



1 x
60 W



IP44



9 002759 962395



94843 HILBURN

wall light; zinc-plated steel, black / plastic, transparent
Wandleuchte; Stahl verzinkt, schwarz / Kunststoff, transparent
Applique; acier galvanisé, noir / plastique, transparent

L 200, H 280, A 200



E27



1 x
60 W



IP44



9 002759 948436



94866 HILBURN 1

wall light; zinc-plated steel, antique silver / plastic, transparent
Wandleuchte; Stahl verzinkt, silber-antik / Kunststoff, transparent
Applique; acier galvanisé, argent antique / plastique, transparent

L 200, H 280, A 200



E27



1 x
60 W



IP44



9 002759 948665





97226





88489



83589

97226 CANOVE

wall light; zinc-plated steel, black / glass, clear, satin finish
Wandleuchte; Stahl verzinkt, schwarz / Glas, klar, satiniert
Applique; acier galvanisé, noir / verre, transparent, satiné

L 230, H 240, A 235



E27



1 x
60 W



IP55



9 002759 972264

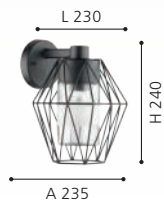

88489 MILTON

wall light; steel, zinc-plated / glass, clear
Wandleuchte; Stahl, feuerverzinkt / Glas, klar
Applique; acier, galvanisé à chaud / verre, transparent

H 310, A 310



E27



1 x
60 W



IP44



9 002759 884895



83589 MILTON

wall light; zinc-plated steel, antique brown / glass, clear
Wandleuchte; Stahl verzinkt, antik-braun / Glas, klar
Applique; acier galvanisé, marron antique / verre, transparent

B 240, H 310, A 300



E27



1 x
60 W



IP44



9 002759 835897





94792



94863



90184

94792 MELGOA

wall light; zinc-plated steel, black / glass, clear
Wandleuchte; Stahl verzinkt, schwarz / Glas, klar
Applique; acier galvanisé, noir / verre, transparent

L 300, H 250, A 380



E27



1 x
60 W



IP44



9 002759 947927



94863 MELGOA

wall light; zinc-plated steel, antique copper coloured / glass, clear
Wandleuchte; Stahl verzinkt, kupferfarben-antik / Glas, klar
Applique; acier galvanisé, cuivré antique / verre, transparent

L 300, H 250, A 380



E27



1 x
60 W



IP44



9 002759 948634



90184 SAN TELMO

wall light; zinc-plated steel, cast alumin, antique brown / glass with air bubbles, clear
Wandleuchte; Stahl verzinkt, Aluguss, antik-braun / Glas mit Lufteinschlüssen, klar
Applique; acier galvanisé, fonte d'alumi, marron antique / verre avec bulles d'air, transparent

L 180, H 350, A 240



E27



1 x
60 W



IP23



9 002759 901844





94855



96241



96262

94855 PULFERO 1

wall light; zinc-plated steel, brown / plastic, transparent
Wandleuchte; Stahl verzinkt, braun / Kunststoff, transparent
Applique; acier galvanisé, marron / plastique, transparent

L 220, H 280, A 280



E27



1 x
60 W



IP44



9 002759 948559

96241 VALDEO

wall light; zinc-plated steel, antique copper coloured / glass, clear
Wandleuchte; Stahl verzinkt, kupferfarben-antik / Glas, klar
Applique; acier galvanisé, cuivré antique / verre, transparent

L 165, H 275, A 200



E27



1 x
60 W



IP44



9 002759 962418

96262 ALBACETE

wall light; zinc-plated steel, brown, copper / glass with air bubbles, clear
Wandleuchte; Stahl verzinkt, braun, kupfer / Glas mit Lufteinschlüssen, klar
Applique; acier galvanisé, marron, cuivre / verre avec bulles d'air, transparent
L 265, H 255, A 280



E27



1 x
40 W



IP44



9 002759 962623



93097



93098



93407

93097 ALORIA

wall light; cast aluminium, black / plastic, clear
Wandleuchte; Aluguss, schwarz / Kunststoff, klar
Applique; fonte d'aluminium, noir / plastique, transparent

L 170, H 225, A 190



93098 ALORIA

wall light; cast aluminium, black / plastic, clear
Wandleuchte; Aluguss, schwarz / Kunststoff, klar
Applique; fonte d'aluminium, noir / plastique, transparent

L 170, H 225, A 190



93407 ALORIA

wall light; cast aluminium, black / plastic, clear
Wandleuchte; Aluguss, schwarz / Kunststoff, klar
Applique; fonte d'aluminium, noir / plastique, transparent

L 180, H 200, A 120

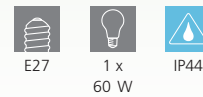



93408



93403



93095

93408 ALORIA

floor light; cast aluminium, black / plastic, clear
 Stehleuchte; Aluguss, schwarz / Kunststoff, klar
 lampadaire; fonte d'aluminium, noir / plastique, transparent

L 170, B 170, H 940, Base: Ø 170



E27



1 x
60 W



IP44



9 002759 934088

93403 ALORIA

wall light; cast aluminium, white / plastic, clear
 Wandleuchte; Aluguss, weiss / Kunststoff, klar
 Applique; fonte d'aluminium, blanc / plastique, transparent

L 180, H 200, A 120



E27



1 x
60 W



IP44



9 002759 934033

93095 ALORIA

wall light; cast aluminium, white / plastic, clear
 Wandleuchte; Aluguss, weiss / Kunststoff, klar
 Applique; fonte d'aluminium, blanc / plastique, transparent

L 170, H 225, A 190



E27



1 x
60 W



IP44



9 002759 930950



93456



93457



93458



110°, 7 m
5 sec. - 5 min.

**SAFETY &
COMFORT**

93456 NAVEDO

wall light; cast aluminium, black, silver-patina / glass, clear
Wandleuchte; Aluguss, schwarz, silber-patina / Glas, klar
Applique; fonte d'aluminium, noir, argent patiné / verre, transparent

L 200, H 475, A 285



E27



1 x
60 W



IP44



9 002759 934569



93457 NAVEDO

wall light; cast aluminium, black, silver-patina / glass, clear
Wandleuchte; Aluguss, schwarz, silber-patina / Glas, klar
Applique; fonte d'aluminium, noir, argent patiné / verre, transparent

L 200, H 475, A 285



E27



1 x
60 W



IP44



9 002759 934576



93458 NAVEDO

wall light; cast aluminium, black, silver-patina / glass, clear
Wandleuchte; Aluguss, schwarz, silber-patina / Glas, klar
Applique; fonte d'aluminium, noir, argent patiné / verre, transparent

L 200, H 425, A 285



E27



1 x
60 W



IP44



9 002759 934583





93459



93462

DESIGN
HIGHLIGHT
DETAIL



93459 NAVEDO

wall light; cast aluminium, black, silver-patina / glass, clear
Wandleuchte; Aluguss, schwarz, silber-patina / Glas, klar
Applique; fonte d'aluminium, noir, argent patiné / verre, transparent

L 290, H 430, A 130



E27



1 x
60 W



IP44



9 002759 934590

93462 NAVEDO

pedestal light; cast aluminium, black, silver-patina / glass, clear
Sockelleuchte; Aluguss, schwarz, silber-patina / Glas, klar
luminaire pour socle; fonte d'aluminium, noir, argent patiné / verre, transparent

H 470, Ø 230, Base: Ø 170



E27



1 x
60 W



IP44



9 002759 934620



93464



93465

93464 NAVEDO

floor light; cast aluminium, black, silver-patina / glass, clear
Stehleuchte; Aluguss, schwarz, silber-patina / Glas, klar
lampadaire; fonte d'aluminium, noir, argent patiné / verre, transparent

H 2000, Ø 230, Base: Ø 245



9 002759 934644



93465 NAVEDO

floor light; cast aluminium, black, silver-patina / glass, clear
Stehleuchte; Aluguss, schwarz, silber-patina / Glas, klar
lampadaire; fonte d'aluminium, noir, argent patiné / verre, transparent

H 2200, Ø 560, Base: Ø 230



9 002759 934651



93463 NAVEDO

floor light; cast aluminium, black, silver-patina / glass, clear
Stehleuchte; Aluguss, schwarz, silber-patina / Glas, klar
lampadaire; fonte d'aluminium, noir, argent patiné / verre, transparent

H 1200, Ø 230, Base: Ø 170

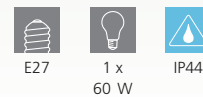

9 002759 934637





93463



DESIGN
HIGHLIGHT
DETAIL



93452

93452 NAVEDO

floor light; cast aluminium, white / glass, clear
Stehleuchte; Aluguss, weiss / Glas, klar
lampadaire; fonte d'aluminium, blanc / verre, transparent

H 1200, Ø 230, Base: Ø 170



E27



1 x
60 W



IP44



9 002759 934521



93454

93454 NAVEDO

floor light; cast aluminium, white / glass, clear
Stehleuchte; Aluguss, weiss / Glas, klar
lampadaire; fonte d'aluminium, blanc / verre, transparent

H 2200, Ø 560, Base: Ø 230



E27



3 x
60 W



IP44



9 002759 934545

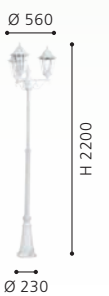



93447



110°, 7 m
5 sec. - 5 min.

**SAFETY &
COMFORT**



93445

93447 NAVEDO

wall light; cast aluminium, white / glass, clear
Wandleuchte; Aluguss, weiss / Glas, klar
Applique; fonte d'aluminium, blanc / verre, transparent

L 200, H 425, A 285



E27



1 x
60 W



IP44



9 002759 934477

93445 NAVEDO

wall light; cast aluminium, white / glass, clear
Wandleuchte; Aluguss, weiss / Glas, klar
Applique; fonte d'aluminium, blanc / verre, transparent

L 200, H 475, A 285



E27



1 x
60 W



IP44



9 002759 934453



22467



DESIGN
HIGHLIGHT
DETAIL

22467 LATERNA 4

wall light; cast aluminium, black / glass, clear
Wandleuchte; Aluguss, schwarz / Glas, klar
Applique; fonte d'aluminium, noir / verre, transparent

L 165, H 350, A 210



E27



1 x
60 W



IP44



9 002759 224677





22468



22469



120°, 8 m
5 sec. - 9 min.

**SAFETY &
COMFORT**



22471

22468 LATERNA 4

wall light; cast aluminium, black / glass, clear
Wandleuchte; Aluguss, schwarz / Glas, klar
Applique; fonte d'aluminium, noir / verre, transparent

L 165, H 320, A 230



E27



1 x
60 W



IP44



9 002759 224684



22469 LATERNA 4

wall light; cast aluminium, black / glass, clear
Wandleuchte; Aluguss, schwarz / Glas, klar
Applique; fonte d'aluminium, noir / verre, transparent

L 165, H 360, A 215



E27



1 x
60 W



IP44



9 002759 224691



22471 LATERNA 4

pendant light; cast aluminium, black / glass, clear
Hängeleuchte; Aluguss, schwarz / Glas, klar
luminaire en suspension; fonte d'aluminium, noir / verre, transparent

H 900, Ø 205



E27



1 x
60 W



IP44



9 002759 224714



DESIGN
HIGHLIGHT
DETAIL



22472



22144

22472 LATERNA 4

pedestal light; cast aluminium, black / glass, clear
Sockelleuchte; Aluguss, schwarz / Glas, klar
luminaire pour socle; fonte d'aluminium, noir / verre, transparent

H 385, Ø 195, Base: Ø 170

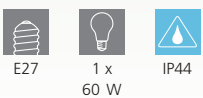

E27
1 x
60 W
IP44



9 002759 224721



22144 LATERNA 4

floor light; cast aluminium, black / glass, clear
Stehleuchte; Aluguss, schwarz / Glas, klar
lampadaire; fonte d'aluminium, noir / verre, transparent

H 1000, Ø 205, Base: Ø 170

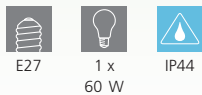

E27
1 x
60 W
IP44



9 002759 221447



22145 LATERNA 4

floor light; cast aluminium, black / glass, clear
Stehleuchte; Aluguss, schwarz / Glas, klar
lampadaire; fonte d'aluminium, noir / verre, transparent

H 1920, Ø 550, Base: Ø 260



E27
3 x
60 W
IP44



9 002759 221454





22145



22462



22463



22464



120°, 8 m
5 sec. - 9 min.

**SAFETY &
COMFORT**

22462 LATERNA 5

wall light; cast aluminium, white / glass, clear
Wandleuchte; Aluguss, weiss / Glas, klar
Applique; fonte d'aluminium, blanc / verre, transparent

22463 LATERNA 5

wall light; cast aluminium, white / glass, clear
Wandleuchte; Aluguss, weiss / Glas, klar
Applique; fonte d'aluminium, blanc / verre, transparent

22464 LATERNA 5

wall light; cast aluminium, white / glass, clear
Wandleuchte; Aluguss, weiss / Glas, klar
Applique; fonte d'aluminium, blanc / verre, transparent

L 165, H 350, A 210



9 002759 224622



L 165, H 320, A 230



9 002759 224639



L 165, H 360, A 215

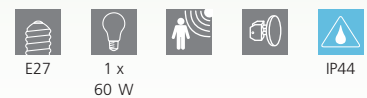

9 002759 224646





22466



22995



22996

22466 LATERNA 5

pedestal light; cast aluminium, white / glass, clear
Sockelleuchte; Aluguss, weiss / Glas, klar
luminaire pour socle; fonte d'aluminium, blanc / verre, transparent

H 385, Ø 195, Base: Ø 170



E27



1 x
60 W



IP44



9 002759 224660

22995 LATERNA 5

floor light; cast aluminium, white / glass, clear
Stehleuchte; Aluguss, weiss / Glas, klar
lampadaire; fonte d'aluminium, blanc / verre, transparent

H 1030, Ø 195, Base: Ø 170



E27



1 x
60 W



IP44



9 002759 229955

22996 LATERNA 5

floor light; cast aluminium, white / glass, clear
Stehleuchte; Aluguss, weiss / Glas, klar
lampadaire; fonte d'aluminium, blanc / verre, transparent

H 1920, Ø 535, Base: Ø 260



E27



3 x
60 W



IP44



9 002759 229962

DESIGN
HIGHLIGHT
DETAIL



89767

89767 ONJA

wall light; cast aluminium, black / fluted glass, clear
Wandleuchte; Aluguss, schwarz / Glas geriffelt, klar
Applique; fonte d'aluminium, noir / verre cannelé, transparent

L 220, H 155, A 125



E27



1 x
40 W



IP44



9 002759 897673



89768 ONJA

wall light; cast aluminium, white / fluted glass, clear
Wandleuchte; Aluguss, weiss / Glas geriffelt, klar
Applique; fonte d'aluminium, blanc / verre cannelé, transparent

L 220, H 155, A 125



E27



1 x
40 W



IP44



9 002759 897680





89768

ONJA

With direct and indirect light these luminaires create a spectacular effect.

Diese Leuchten schaffen durch direktes und indirektes Licht einen tollen Effekt.

Avec la lumière directe et indirecte, ces luminaires créent un effet spectaculaire.



FUNCTIONAL

FUNKTIONELL
FONCTIONNEL



EN HIGHLIGHTS FOR OUTDOORS

Any outdoor area can be skilfully presented with spots, fitted lamps and the associated accessories. Stairwells, paths or the favourite spot in your garden will become a highlight this way.

DE HIGHLIGHTS FÜR DRAUSSEN

Mit Spots, Einbauleuchten und den dazugehörigen Accessoires lässt sich jeder Außenbereich gekonnt in Szene setzen. Treppenaufgänge, Wege oder der Lieblingssplatz im Garten werden so zum Highlight.

FR POINTS FORTS POUR L'EXTÉRIEUR

Des spots, les luminaires encastrables et les accessoires associés mettent en scène avec savoir tout espace extérieur. Les accès à des escaliers, les chemins ou bien votre emplacement préféré deviennent ainsi le centre des attentions.



OVERVIEW

FUNCTIONAL
FUNKTIONELL
FONCTIONNEL



This product is available in different colors and shapes. / Dieser Artikel ist in unterschiedlichen Farben und Formen verfügbar. / Cet article est disponible en différentes couleurs et formes.

94111

NEMA comes with 3 different coloured bulb shades.

NEMA wird mit 3 verschiedenfarbigen Leuchtmittelabdeckungen ausgeliefert.

NEMA vient avec 3 couvercles d'ampoule en couleurs différentes.



94111



93384



94111 NEMA

ground spike; stainless steel, stainless steel
Erdspeiß; Edelstahl, edelstahl
piquet de terre; acier inoxydable, acier inoxydable

L 110, B 85, H 240, ET 165



GU10



1 x
4,5 W



1 x
345 lm



1500



IP54



9 002759 941116



93384 NEMA 1

ground spike; plastic, black / plastic, transparent
Erdspeiß; Kunststoff, schwarz / Kunststoff, transparent
piquet de terre; plastique, noir / plastique, transparent

L 115, B 60, H 185



GU10



1 x
2,8 W



1 x
250 lm



2000



IP44



9 002759 933845





97471



98185

LED



97471 FAEDO 4

ground spike; aluminium, black / glass, clear
 Erdspieß; Alu, schwarz / Glas, klar
 piquet de terre; aluminium, noir / verre, transparent

L 115, B 35, H 310

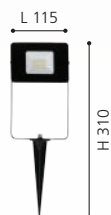

98185 FAEDO 4

flood light; aluminium, black / plastic, white
 Strahler; Alu, schwarz / Kunststoff, weiss
 projecteur; aluminium, noir / plastique, blanc

L 130, H 90, A 25



98185

This FAEDO 4 comes with included remote control.

Diese FAEDO 4 wird mit einer Fernbedienung ausgeliefert.

Ce FAEDO 4 est livré avec une télécommande.



98176

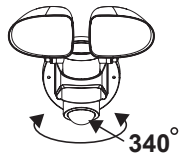

The spotlights of the luminaires are movable. The sensors of the luminaires can be swivelled 180 degrees horizontally and 135 degrees vertically. The sensor of the luminaires can be swivelled horizontally by 340 degrees.

Die Strahler der Leuchten sind beweglich. Die Sensoren der Leuchten sind um 180 Grad horizontal und 135 Grad vertikal schwenkbar. Der Sensor der Leuchten ist um 340 Grad horizontal schwenkbar.

Les spots du luminaires sont mobiles. Les capteurs du luminaires sont orientables de 180 degrés à l'horizontale et de 135 degrés à la verticale. Le capteur de la luminaire est inclinable de 340 degrés à l'horizontale, peut être orienté.

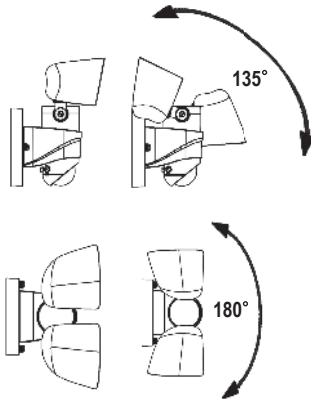

98176



150°, 12 m
5 sec. - 3 min.

SAFETY & COMFORT

98176 PAGINO

wall light; plastic, black
Wandleuchte; Kunststoff, schwarz
Applique; plastique, noir

L 245, H 220, A 180



1 x
11,5 W



1 x
1800 lm



9 002759 981761



98178 PAGINO

wall light; plastic, black
Wandleuchte; Kunststoff, schwarz
Applique; plastique, noir

L 180, H 260, A 160



1 x
11,5 W



1 x
2200 lm



9 002759 981785





98178



150°, 12 m
5 sec. - 3 min.

**SAFETY &
COMFORT**





97455



97456



97457



97455 FAEDO 3

wall light; aluminium, black / glass, clear
Wandleuchte; Alu, schwarz / Glas, klar
Applique; aluminium, noir / verre, transparent

97456 FAEDO 3

wall light; aluminium, black / glass, clear
Wandleuchte; Alu, schwarz / Glas, klar
Applique; aluminium, noir / verre, transparent

97457 FAEDO 3

wall light; aluminium, black / glass, clear
Wandleuchte; Alu, schwarz / Glas, klar
Applique; aluminium, noir / verre, transparent

L 110, H 80, A 30



1 x 10 W
1 x 1000 lm

L 130, H 95, A 30



1 x 21 W
1 x 2300 lm

L 175, H 135, A 30



1 x 31 W
1 x 3400 lm



9 002759 974558



9 002759 974565



9 002759 974572

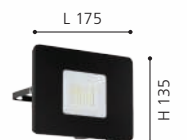



97458



900256



97458 FAEDO 3

wall light; aluminium, black / glass, clear
Wandleuchte; Alu, schwarz / Glas, klar
Applique; aluminium, noir / verre, transparent

L 205, H 145, A 30



1 x
53 W



1 x
5800 lm



IP65



9 002759 974589



900256 FAEDO 3

wall light; aluminium, black / glass, clear
Wandleuchte; Alu, schwarz / Glas, klar
Applique; aluminium, noir / verre, transparent

L 270, H 190, A 35



1 x
102 W



1 x
11100 lm



IP65



9 008606 234547





97459



120°, 12 m
5 sec. - 5 min.

**SAFETY &
COMFORT**



97461



120°, 12 m
5 sec. - 5 min.

**SAFETY &
COMFORT**



97462



120°, 12 m
5 sec. - 5 min.

**SAFETY &
COMFORT**

97459 FAEDO 3

wall light; aluminium, black / glass, clear
Wandleuchte; Alu, schwarz / Glas, klar
Applique; aluminium, noir / verre, transparent

97461 FAEDO 3

wall light; aluminium, black / glass, clear
Wandleuchte; Alu, schwarz / Glas, klar
Applique; aluminium, noir / verre, transparent

97462 FAEDO 3

wall light; aluminium, black / glass, clear
Wandleuchte; Alu, schwarz / Glas, klar
Applique; aluminium, noir / verre, transparent

L 110, H 135, A 50



1 x
10 W

1 x
1000 lm



IP44



9 002759 974596



L 130, H 140, A 50



1 x
21 W

1 x
2300 lm



IP44



9 002759 974619



L 175, H 190, A 50



1 x
31 W

1 x
3400 lm



IP44



9 002759 974626





900257



120°, 1 m
5 sec. - 10 min.

SAFETY & COMFORT

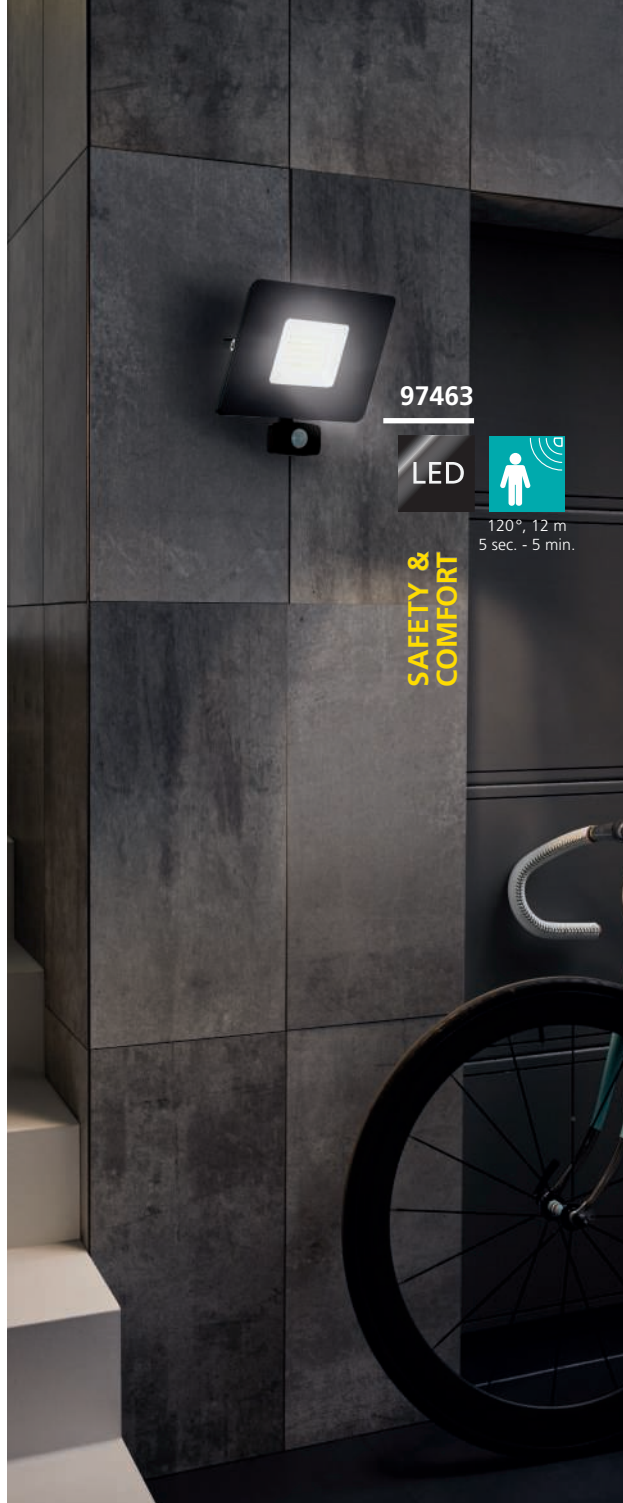

97463



120°, 12 m
5 sec. - 5 min.

SAFETY & COMFORT

900257 FAEDO 3

wall light; aluminium, black / glass, clear
Wandleuchte; Alu, schwarz / Glas, klar
Applique; aluminium, noir / verre, transparent

L 295, H 260, A 60



1 x

102 W



1 x

11100 lm



IP44

L 295



9 008606 234554

97463 FAEDO 3

wall light; aluminium, black / glass, clear
Wandleuchte; Alu, schwarz / Glas, klar
Applique; aluminium, noir / verre, transparent

L 205, H 200, A 50



1 x

53 W



1 x

5800 lm



IP44

L 205



9 002759 974633



33152



33154



33155



33152 FAEDO 3

wall light; aluminium, white / glass, clear
Wandleuchte; Alu, weiss / Glas, klar
Applique; aluminium, blanc / verre, transparent

33154 FAEDO 3

wall light; aluminium, white / glass, clear
Wandleuchte; Alu, weiss / Glas, klar
Applique; aluminium, blanc / verre, transparent

33155 FAEDO 3

wall light; aluminium, white / glass, clear
Wandleuchte; Alu, weiss / Glas, klar
Applique; aluminium, blanc / verre, transparent

L 110, H 80, A 30



1 x 10 W
1 x 1000 lm

L 175, B 40, H 135, A 80



1 x 31 W
1 x 3400 lm

L 205, H 145, A 30



1 x 53 W
1 x 5800 lm



9 002759 331528

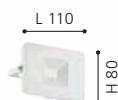

9 002759 331542



9 002759 331559

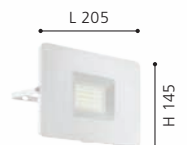



33153 FAEDO 3

wall light; aluminium, white / glass, clear
Wandleuchte; Alu, weiss / Glas, klar
Applique; aluminium, blanc / verre, transparent

L 130, H 95, A 30

LED

1 x
21 W

neutral
WHITE

1 x
2300 lm



IP65

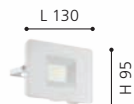



33156



120°, 12 m
5 sec. - 5 min.

**SAFETY &
COMFORT**



33158



120°, 12 m
5 sec. - 5 min.

**SAFETY &
COMFORT**



33159



120°, 12 m
5 sec. - 5 min.

**SAFETY &
COMFORT**

33156 FAEDO 3

wall light; aluminium, white / glass, clear
Wandleuchte; Alu, weiss / Glas, klar
Applique; aluminium, blanc / verre, transparent

33158 FAEDO 3

wall light; aluminium, white / glass, clear
Wandleuchte; Alu, weiss / Glas, klar
Applique; aluminium, blanc / verre, transparent

33159 FAEDO 3

wall light; aluminium, white / glass, clear
Wandleuchte; Alu, weiss / Glas, klar
Applique; aluminium, blanc / verre, transparent

L 110, H 135, A 50



1 x
10 W 1 x
1000 lm

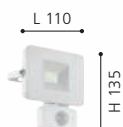

L 175, H 190, A 50



1 x
31 W 1 x
3400 lm



L 205, H 200, A 50



1 x
53 W 1 x
5800 lm

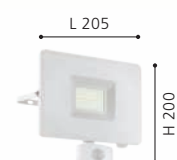



33157



120°, 12 m
5 sec. - 5 min.

SAFETY &
COMFORT

33157 FAEDO 3

wall light; aluminium, white / glass, clear

Wandleuchte; Alu, weiss / Glas, klar

Applique; aluminium, blanc / verre, transparent

L 130, H 140, A 50

LED

neutral
WHITE



1 x

1 x

21 W

2300 lm



IP44



9 002759 331573

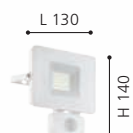



97465



160°, 12 m
10 sec. - 15 min.

**SAFETY &
COMFORT**



96454



180°, 12 m
10 sec. - 15 min.

**SAFETY &
COMFORT**



97422



360°, 12 m
10 sec. - 15 min.

**SAFETY &
COMFORT**

97465 DETECT ME 3

motion detector; plastic, black
Bewegungsmelder; Kunststoff, schwarz
détecteur de mouvement; plastique, noir

L 100, H 100, A 50



IP44



9 002759 974657

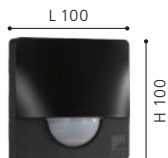

96454 DETECT ME 1

motion detector; plastic, black
Bewegungsmelder; Kunststoff, schwarz
détecteur de mouvement; plastique, noir

L 55, H 70, A 80



IP44



9 002759 964542

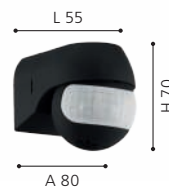

97422 DETECT ME 6

motion detector; plastic, black / plastic, white
Bewegungsmelder; Kunststoff, schwarz / Kunststoff, weiss
détecteur de mouvement; plastique, noir / plastique, blanc

Ø 90, A 55



IP44



9 002759 974220





96452

180°, 12 m
10 sec. - 15 min.

SAFETY & COMFORT



97464

160°, 12 m
10 sec. - 15 min.

SAFETY & COMFORT



97421

360°, 12 m
10 sec. - 15 min.

SAFETY & COMFORT



DETECT ME 1

DETECT ME 3

DETECT ME 6



		•
•	•	

Accessories incl. / Zubehör inkl. / Accessoires inclus



10 sec. - 15 min.	10 sec. - 15 min.	10 sec. - 15 min.
12 m	12 m	12 m
180°	160°	360°
+/- 40° horizontal +/- 45° vertical		
3 - 2000 lx	3 - 2000 lx	3 - 2000 lx
max. 800 W incandescent max. 400 W fluorescent/LED	max. 1200 W incandescent max. 300 W fluorescent/LED	max. 1200 W incandescent max. 300 W fluorescent/LED

Ideal mounting height / Ideale Montagehöhe / Hauteur de montage ideale: ~ 2m

96452 DETECT ME 1

motion detector; plastic, white
Bewegungsmelder; Kunststoff, weiss
détecteur de mouvement; plastique, blanc

L 55, H 70, A 80

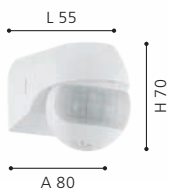

97464 DETECT ME 3

motion detector; plastic, white
Bewegungsmelder; Kunststoff, weiss
détecteur de mouvement; plastique, blanc

L 100, H 100, A 50

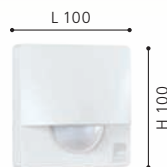

97421 DETECT ME 6

motion detector; plastic, white / plastic, white
Bewegungsmelder; Kunststoff, weiss / Kunststoff, weiss
détecteur de mouvement; plastique, blanc / plastique, blanc

Ø 90, A 55





93481



86189



93481 LAMEDO

recessed ground light; stainless steel, stainless steel / satin glass, white

Bodeneinbauleuchte; Edelstahl, edelstahl / Glas satiniert, weiss
luminaire enc. au sol; acier inoxydable, acier inoxydable / verre satiné, blanc

L 100, B 100, ET 65

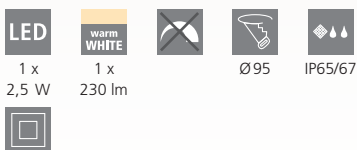

9 002759 934811

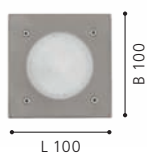

86189 RIGA 3

recessed ground light; stainless steel, stainless steel / plastic, white

Bodeneinbauleuchte; Edelstahl, edelstahl / Kunststoff, weiss
luminaire enc. au sol; acier inoxydable, acier inoxydable / plastique, blanc

H 285, Ø 170



9 002759 861896



93482 LAMEDO

recessed ground light; stainless steel, stainless steel / satin glass, white

Bodeneinbauleuchte; Edelstahl, edelstahl / Glas satiniert, weiss
luminaire enc. au sol; acier inoxydable, acier inoxydable / verre satiné, blanc

Ø 100, ET 65



9 002759 934828





93482

LED

HIGH
IP



95235

LED

HIGH
IP



88575



94093



95235 ZIMBA-LED

recessed light; cast aluminium, silver
Einbauleuchte; Aluguss, silber
luminaire encastrable; fonte d'aluminium, argent

L 140, B 140, H 5, ET 95



1 x
3,7 W



1 x
500 lm



133x130



IP65



9 002759 952358

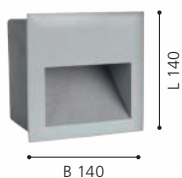

B 140

88575 ZIMBA

recessed light; cast aluminium, silver / satin glass, white
Einbauleuchte; Aluguss, silber / Glas satiniert, weiss
luminaire encastrable; fonte d'aluminium, argent / verre satiné, blanc

L 227, B 127, H 13, ET 75



E14



1 x
40 W



196x96



IP44



9 002759 885755



L 227

94093 MARGO

recessed light; cast aluminium, white / satin glass, white
Einbauleuchte; Aluguss, weiss / Glas satiniert, weiss
luminaire encastrable; fonte d'aluminium, blanc / verre satiné, blanc

H 10, Ø 84, ET 125



GU10



1 x
4,5 W



1 x
345 lm



Ø 78



IP65/20



9 002759 940935



Ø 84

SAFETY &
COMFORT



DAY & NIGHT
SENSOR
INTEGRATED

110187 E27-LED-A60

806 lm	warm WHITE	3000 K	
---------------	-------------------	---------------	--

L 106, Ø 60	not dimmable	80 CRI
7.3 W	25000 h	Day/night-Sensor
220-240V,50/60Hz	8	
E27	7.3 W ~ 60 W	



9 008606 229086

SAFETY &
COMFORT



DAY & NIGHT
SENSOR
INTEGRATED

110189 E27-LED-A60

470 lm	warm WHITE	3000 K	
---------------	-------------------	---------------	--

L 106, Ø 60	not dimmable	80 CRI
4.5 W	25000 h	Day/night-Sensor
220-240V,50/60Hz	8	
E27	4.5 W ~ 40 W	



9 008606 229109

SAFETY &
COMFORT



MOTION
SENSOR,
DAY & NIGHT
SENSOR
INTEGRATED

110186 E27-LED-A60

830 lm	warm WHITE	2700 K	
---------------	-------------------	---------------	--

L 112, Ø 60	not dimmable	80 CRI
6.1 W	25000 h	Motion Sensor & day/night-Sensor
220-240V,50/60Hz	8	
E27	6.1 W ~ 61 W	



9 008606 229079



DAY & NIGHT
SENSOR
INTEGRATED

110186, 110187, 110189

These bulbs have a Day & Night sensor and switch on automatically when it gets dark or off when it gets bright. Thanks to the E27 socket the bulbs can be easily replaced in existing luminaires. With an average electricity price of € 0.16 / KWh and an average lighting duration of 8 hours / day, the costs amount to approx. € 5.00 per year.

Diese Leuchtmittel verfügen über einen Day & Night -Sensor und schalten sich selbständig bei Dunkelheit ein bzw. bei Helligkeit aus. Dank der E27 -Fassung können die Leuchtmittel einfach in bestehende Leuchten getauscht werden. Bei einem durchschnittlichen Strompreis von € 0,16 / KWh und einer durchschnittlichen Leuchtdauer von 8 Stunden / Tag belaufen sich die Kosten auf ca. € 5,00 pro Jahr.

Ces ampoules sont équipées d'un capteur Day & Night et s'allument automatiquement dans l'obscurité et s'éteignent automatiquement lorsqu'il fait clair. Grâce à la douille E27 les ampoules peuvent être facilement remplacées dans les luminaires existants. Avec un prix moyen de l'électricité de € 0,16 / KWh et une durée moyenne de d'une durée d'éclairage de 8 heures / jour, les coûts s'élèvent à environ € 5,00 par an.



110186



MICROWAVE MOTION SENSOR

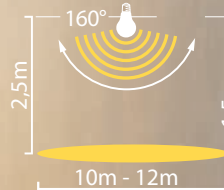



90748



93426

90748 PARK 4

accessory; stainless steel, stainless steel / plastic, green
Zubehör; Edelstahl, edelstahl / Kunststoff, grün
Accessoires; acier inoxydable, acier inoxydable / plastique, marron granit

L 110, B 110, H 400, Base: B 155, T 155



IP44



9 002759 907488





91206



CONNECTOR BOX

No more annoying cables in your garden: bury them simply and safely with the CONNECTOR BOX.

- 91206: 1 supply line and 2 distribution lines
- 91207: 1 supply line and 5 distribution lines

Mit der CONNECTOR BOX können Sie störende Kabel einfach und sicher unter der Erde verschwinden lassen.

- 91206: 1 Zuleitung und 2 Verteilungsleitungen
- 91207: 1 Zuleitung und 5 Verteilungsleitungen

Tous les câbles incommodants disparaissent simplement et sûrement dans votre jardin avec CONNECTOR BOX.

- 91206: 1 alimentation et 2 lignes de distribution
- 91207: 1 alimentation et 5 lignes de distribution



91207



93426 PARK 4

accessory; steel, plastic, black
Zubehör; Stahl, Kunststoff, schwarz
Accessoires; acier, plastique, noir

L 110, B 110, H 400, Base: B 155, T 155



IP44



9 002759 934262



91206 CONNECTOR BOX

accessory; plastic, black
Zubehör; Kunststoff, schwarz
Accessoires; plastique, noir

H 50, Ø 155



IP68



9 002759 912062



91207 CONNECTOR BOX

accessory; plastic, black
Zubehör; Kunststoff, schwarz
Accessoires; plastique, noir

H 50, Ø 155



IP68



9 002759 912079



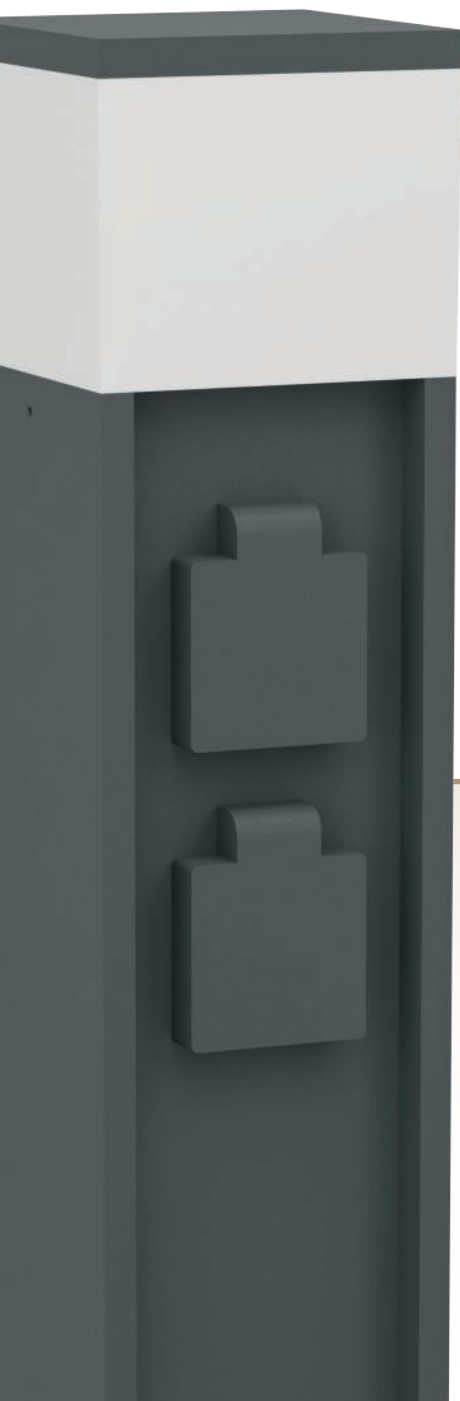

DESIGN
HIGHLIGHT
DETAIL



901031



901031 PARK 5

accessory; aluminium, anthracite
Zubehör; Alu, anthrazit
Accessoires; aluminium, gris anthracite

L 100, B 100, H 300



IP54



9 008606 297818

L 100



H 300

901032 PARK 5

accessory; aluminium, anthracite / plastic, white
Zubehör; Alu, anthrazit / Kunststoff, weiss
Accessoires; aluminium, gris anthracite / plastique, blanc

L 100, B 100, H 500



E27



1 x
25 W



IP54



9 008606 297825

L 100



H 500



901032





88744

88744

With the CUBA ground spike you can stick your floor luminaire in the ground or set it in concrete.

Mit dem CUBA Erdspeer können Sie Ihre Stehleuchte in den Boden stecken oder einbetonieren.

Avec le piquet de terre CUBA vous pouvez fixer votre lampadaire en sol ou au béton.



88153

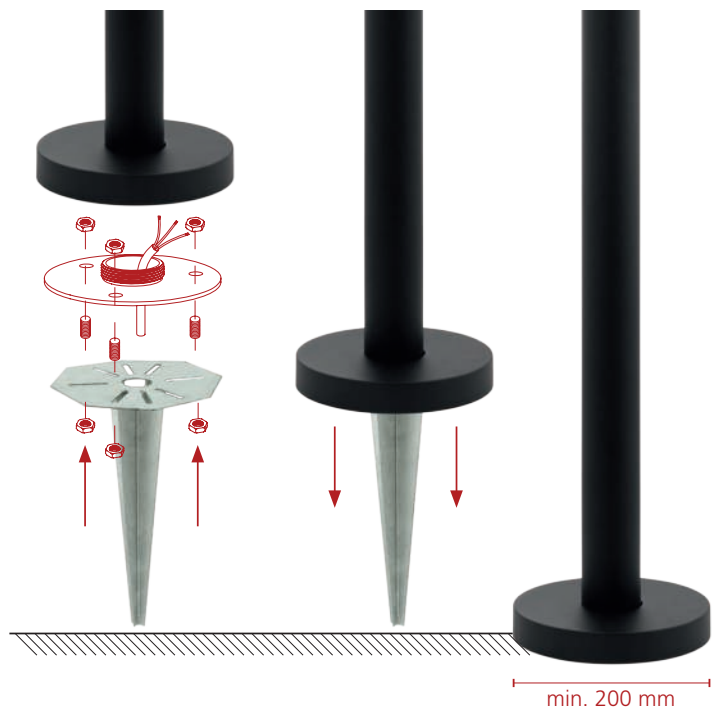

min. 200 mm

88744 CUBA

ground spike; steel, zinc-plated
Erdspeer; Stahl, feuerverzinkt
piquet de terre; acier, galvanisé à chaud

H 300, Ø 200

88153

accessory; steel, black
Zubehör; Stahl, schwarz
Accessoires; acier, noir

H 50, Ø 112

88152

accessory; steel, white
Zubehör; Stahl, weiss
Accessoires; acier, blanc

H 50, Ø 112



9 002759 887445

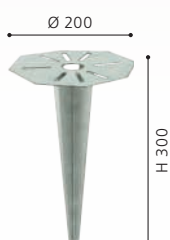

9 002759 881535

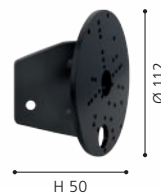

9 002759 881528

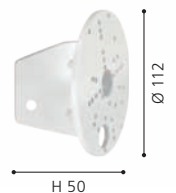



88152



88152, 88153

The above mentioned pictogram indicates suitable luminaires which can be easily mounted on corners with this accessories.

Das oben gezeigte Piktogramm markiert passende Leuchten, welche mit dem Zubehör einfach an Ecken montiert werden können.

Le pictogramme ci-dessus marque les luminaires correspondant, qui peut être monté avec les accessoires simples dans les coins.



SOLAR

SOLAR
SOLAIRE



EN THE GREEN ALTERNATIVE

These exterior lights all feature modern solar technology and high-quality batteries. With zero electricity costs, they make the perfect statement for anyone who values sustainability. Since they don't need cables or a power connection, these lights can be placed anywhere where there is enough sunlight.

DE DIE GRÜNE ALTERNATIVE

Diese Außenleuchten verfügen alle über moderne Solartechnologie und hochwertige Akkus. Sie sind das perfekte Statement für alle jene, denen Nachhaltigkeit wichtig ist und verursachen keine Stromkosten. Unabhängig von Kabel- und Stromanschluss sind diese Leuchten überall platzierbar wo genügend Sonne scheint.

FR LA SOLUTION ÉCOLOGIQUE

Ces luminaires extérieurs sont tous équipés d'une technologie solaire moderne et de batteries performantes. Ils représentent le choix idéal pour tous ceux qui accordent une grande importance à la protection de l'environnement. Par ailleurs, ils n'engendrent pas de frais énergétiques. Ces luminaires n'ont pas besoin d'être raccordés à l'alimentation et peuvent donc être placés partout où ils peuvent être exposés au soleil.



OVERVIEW

SOLAR
SOLAR
SOLAIRE



DREOLI
210



CERRISI
210



ALTILIA
212



PANTETE
215



SPIANTE
216



BARACCONI
216



VOSCARI
217



DARFANO
217



UTRERA
218



CROARA
218



PASTION
218



CORBEZZOLA
219



MARTANO
219



SUZZARA
219



STIAPPA
220



LAMOZZO
220



PORRASSA
221



ORIMINI
221



PANETTIERI
222



CASABAS
223



SAMBUCO
225



GIONATA
225



GIONATA 1
225



ROSALBA
226



ROSALBA 1
226



STAZZONE
227



PUGLIA
228



This product is available in different colors and shapes. / Dieser Artikel ist in unterschiedlichen Farben und Formen verfügbar. / Cet article est disponible en différentes couleurs et formes.

OPERATING MODES

BETRIEBSMODI

MODES DE FONCTIONNEMENT

Our solar luminaires with motion sensor offer an efficient lighting solution for outdoor areas. Most of the lights can be operated in different modes.

In motion mode, the product lights up at full brightness for some time when motion is detected.

In twilight mode, the product is automatically activated at dusk and switched off in daylight. To extend the battery life, the light is operated at reduced brightness in this mode.

An overview of which luminaires can be operated in which mode can be found on the right-hand side.

Unsere Solarleuchten mit Bewegungssensor bieten eine effiziente Beleuchtungslösung für den Außenbereich. Die meisten Leuchten können dabei in verschiedenen Modi betrieben werden.

Im Bewegungsmodus leuchtet das Produkt bei erkannter Bewegung für einige Zeit bei voller Helligkeit auf.

Im Dämmerungsmodus erfolgt die automatische Aktivierung bei Einbruch der Dunkelheit und Abschaltung bei Tageslicht. Um die Batterielebensdauer zu verlängern, wird bei diesem Modus die Leuchte bei reduzierter Helligkeit betrieben.

Eine Übersicht, welche Leuchten in welchem Modus betrieben werden können, finden Sie auf der rechten Seite.

Nos luminaires solaires à détecteur de mouvement offrent une solution d'éclairage efficace pour l'extérieur. La plupart des lampes peuvent être utilisées dans différents modes.

En mode mouvement, le produit s'allume à pleine luminosité pendant un certain temps lorsqu'un mouvement est détecté.

En mode crépusculaire, il s'active automatiquement à la tombée de la nuit et s'éteint à la lumière du jour. Pour prolonger la durée de vie des piles, ce mode permet de faire fonctionner le luminaire à une luminosité réduite.

Vous trouverez sur la droite un aperçu des luminaires qui peuvent être utilisés dans tel ou tel mode.



100% brightness
100% Helligkeit/ 100% Luminosité



SERIES NAME Seriename Nom de la série de lampes	MOTIONSENSOR Bewegungsmodus Capteur de mouvement	 DAY & NIGHT SENSOR Dämmerungsmodus Mode crépusculaire
DREOLI	●	●
CERRISI	●	●
ALTILIA	●	●
PANTETE	●	●
SPIANTE	●	●
BARACCONI	●	●
VOSCARI	●	●
DARFANO	●	●
UTRERA	●	●
CROARA	●	●
PASTION	●	●
CORBEZZOLA	●	
MARTANO	●	
SUZZARA	●	●
STIAPPA	●	●
LAMOZZO	●	●
PORRASSA	●	
PANETTIERI	●	●
CASABAS	●	



901071



120°, 6 m

SAFETY & COMFORT

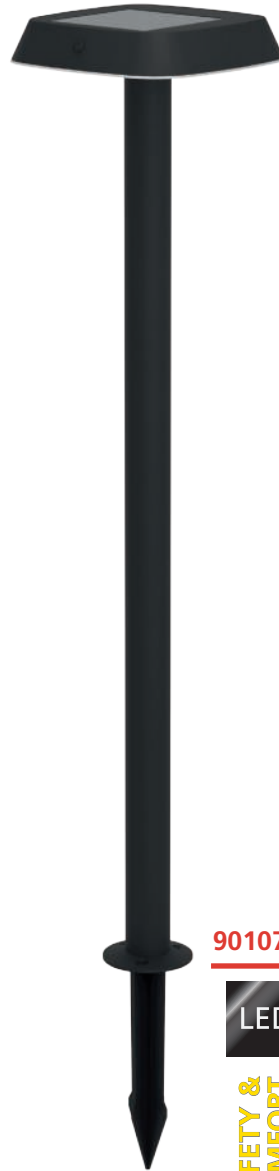

901072



120°, 3 m

SAFETY & COMFORT



901071 DREOLI

solar light; plastic, black / plastic, white
Solarleuchte; Kunststoff, schwarz / Kunststoff, weiss
luminaire solaire; plastique, noir / plastique, blanc

901072 DREOLI

solar light; plastic, black / plastic, white
Solarleuchte; Kunststoff, schwarz / Kunststoff, weiss
luminaire solaire; plastique, noir / plastique, blanc

901079 CERRISI

solar light; plastic, black / plastic, white
Solarleuchte; Kunststoff, schwarz / Kunststoff, weiss
luminaire solaire; plastique, noir / plastique, blanc

L 175, H 210, A 175



9 008606 297986



L 175, B 175, H 1035

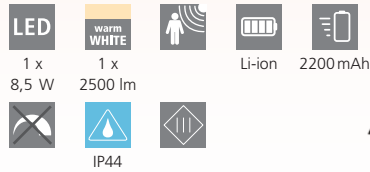

9 008606 297993



L 250, H 105, A 300

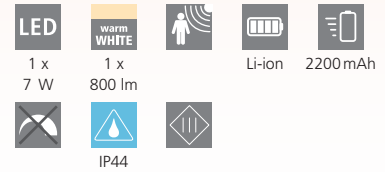

9 008606 298068





901079



120°, 6 m

**SAFETY &
COMFORT**

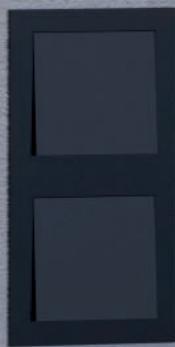



901073



120°, 6 m

SAFETY & COMFORT



901075



120°, 3 m

SAFETY & COMFORT



901073 ALTILIA

solar light; plastic, black / plastic, white
Solarleuchte; Kunststoff, schwarz / Kunststoff, weiss
luminaire solaire; plastique, noir / plastique, blanc

L 155, H 200, A 230

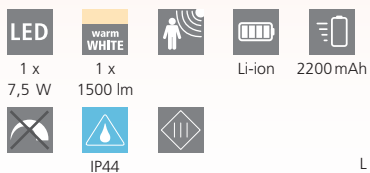

9 008606 298006

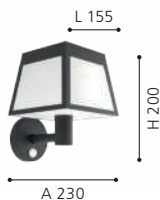

901075 ALTILIA

solar light; plastic, black / plastic, white
Solarleuchte; Kunststoff, schwarz / Kunststoff, weiss
luminaire solaire; plastique, noir / plastique, blanc

L 155, B 155, H 1060

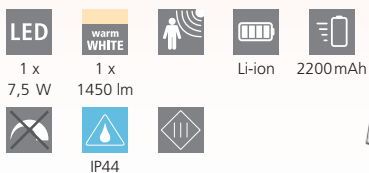

9 008606 298020

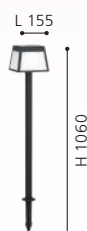

901074 ALTILIA

solar light; plastic, black / plastic, white
Solarleuchte; Kunststoff, schwarz / Kunststoff, weiss
luminaire solaire; plastique, noir / plastique, blanc

L 155, B 155, H 560

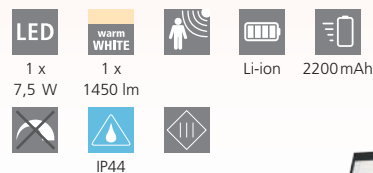

9 008606 298013





901074

LED



120°, 3 m

**SAFETY &
COMFORT**



901076



120°, 6 m

**SAFETY &
COMFORT**





901077



SAFETY & COMFORT



901078



SAFETY & COMFORT

901076 PANTETE

solar light; plastic, black / plastic, white
Solarleuchte; Kunststoff, schwarz / Kunststoff, weiss
luminaire solaire; plastique, noir / plastique, blanc

H 210, Ø 175, A 230

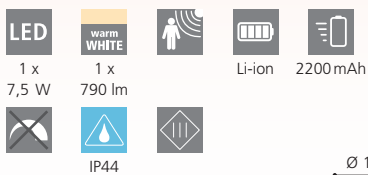

901077 PANTETE

solar light; plastic, black / plastic, white
Solarleuchte; Kunststoff, schwarz / Kunststoff, weiss
luminaire solaire; plastique, noir / plastique, blanc

H 650, Ø 175



901078 PANTETE

solar light; plastic, black / plastic, white
Solarleuchte; Kunststoff, schwarz / Kunststoff, weiss
luminaire solaire; plastique, noir / plastique, blanc

H 1150, Ø 175

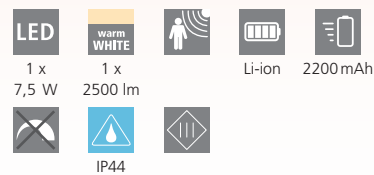



901082



120°, 5 m

SAFETY & COMFORT



900245



90°, 6 m

SAFETY & COMFORT

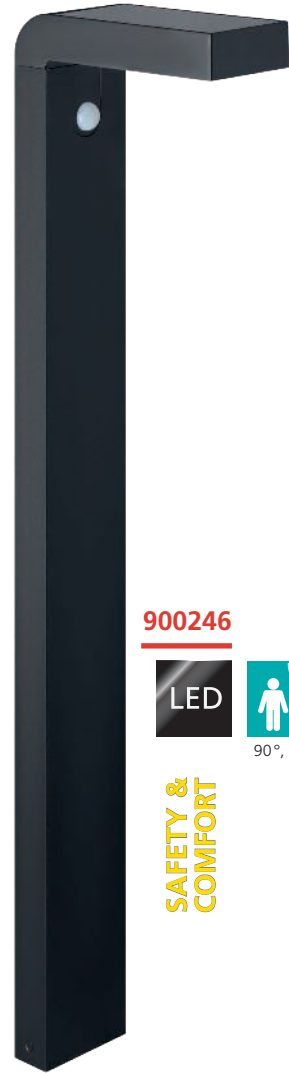

900246



90°, 6 m

SAFETY & COMFORT



901082 SPIANTE

solar light; plastic, black / plastic, white
Solarleuchte; Kunststoff, schwarz / Kunststoff, weiss
luminaire solaire; plastique, noir / plastique, blanc

L 140, H 140, A 140

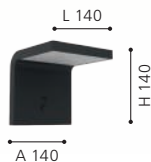
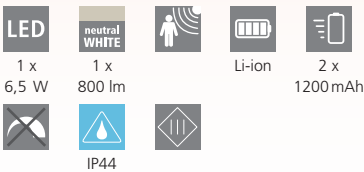

900245 BARACCONI

wall light; aluminium, plastic, black / plastic, transparent
Wandleuchte; Alu, Kunststoff, schwarz / Kunststoff, transparent
Applique; aluminium, plastique, noir / plastique, transparent

L 90, H 200, A 200



900246 BARACCONI

floor light; aluminium, plastic, black / plastic, satin finish
Stehleuchte; Alu, Kunststoff, schwarz / Kunststoff, satiniert
lampadaire; aluminium, plastique, noir / plastique, satiné

L 90, B 200, H 800

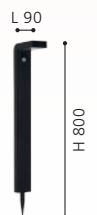



901916



110°, 3 m
30 sec.

**SAFETY &
COMFORT**

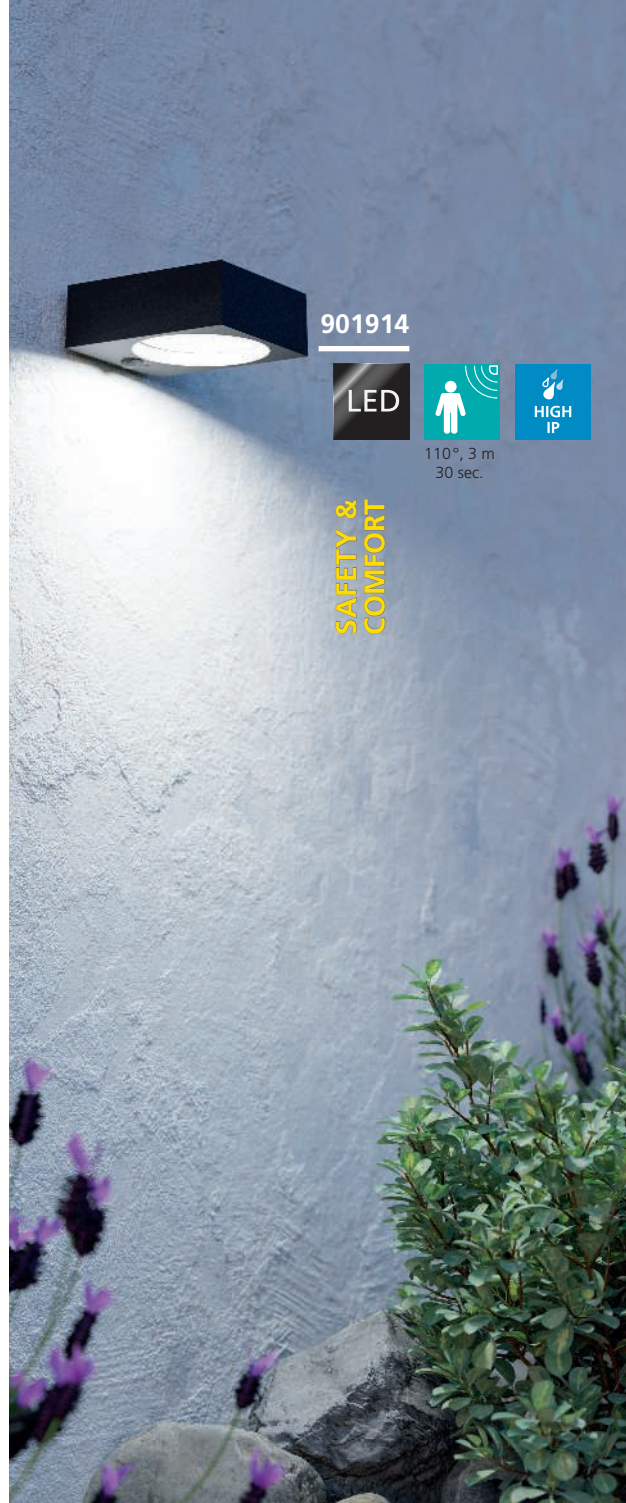

901914



110°, 3 m
30 sec.

**SAFETY &
COMFORT**

901916 VOSCARI

solar light; plastic, black
Solarleuchte; Kunststoff, schwarz
luminaire solaire; plastique, noir

L 285, H 50, A 60



1 x
6,8 W



1 x
932 lm



Li-ion 2000mAh



IP54



901914 DARFANO

solar light; plastic, black
Solarleuchte; Kunststoff, schwarz
luminaire solaire; plastique, noir

L 145, H 55, A 120



1 x
6,5 W



1 x
934 lm



Li-ion 2000mAh



IP54

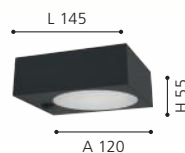



48968



SAFETY & COMFORT



901081



SAFETY & COMFORT



98191

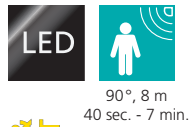

SAFETY & COMFORT

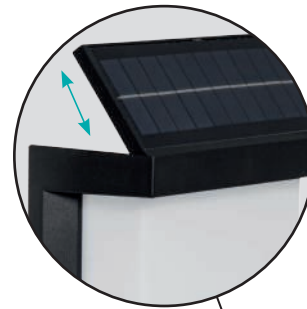

48968, 901083

The solar panel on the item is foldable.

Das Solarpanel am Artikel ist klappbar.

Le panneau solaire sur l'article est pliable.



*except/ außer/ except 98191

48968 UTRERA

solar light; plastic, black / plastic, white
Solarleuchte; Kunststoff, schwarz / Kunststoff, weiss
luminaire solaire; plastique, noir / plastique, blanc

901081 CROARA

solar light; plastic, anthracite / plastic, white
Solarleuchte; Kunststoff, anthrazit / Kunststoff, weiss
luminaire solaire; plastique, gris anthracite / plastique, blanc

98191 PASTION

wall light; plastic, black
Wandleuchte; Kunststoff, schwarz
Applique; plastique, noir

L 200, B 90, H 120

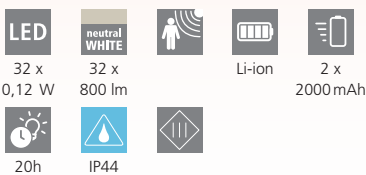

L 150, H 110, A 110

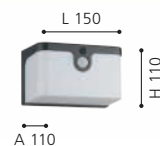

L 180, H 120, A 130

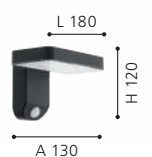



900804

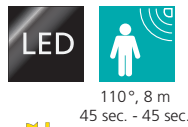

SAFETY & COMFORT



900243



SAFETY & COMFORT

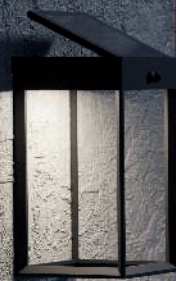

901083



SAFETY & COMFORT

900243 CORBEZZOLA

wall light; plastic, graphite / plastic, white
Wandleuchte; Kunststoff, graphit / Kunststoff, weiss
Applique; plastique, noir graphite / plastique, blanc

L 160, H 160, A 200



900804 MARTANO

wall light; aluminium, black / plastic, white
Wandleuchte; Alu, schwarz / Kunststoff, weiss
Applique; aluminium, noir / plastique, blanc

L 180, B 150, H 270

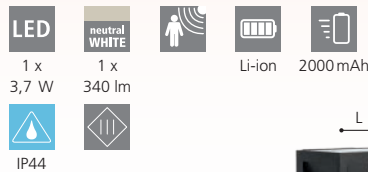

901083 SUZZARA

solar light; plastic, black / plastic, white
Solarleuchte; Kunststoff, schwarz / Kunststoff, weiss
luminaire solaire; plastique, noir / plastique, blanc

L 140, H 250, A 140



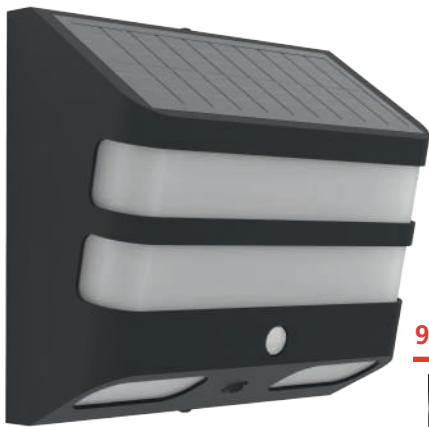

901084



120°, 5 m

SAFETY & COMFORT



98757



120°, 6 m
18 sec. - 25 sec.



SAFETY & COMFORT



900255



120°, 6 m
18 sec. - 25 sec.



SAFETY & COMFORT

901084 STIAPPA

solar light; plastic, black / plastic, white
Solarleuchte; Kunststoff, schwarz / Kunststoff, weiss
luminaire solaire; plastique, noir / plastique, blanc

L 120, H 200, A 80

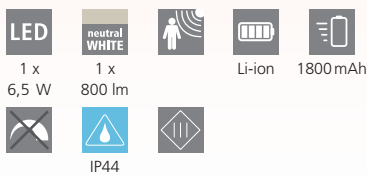

9 008606 297924

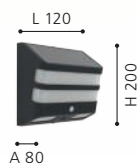

98757 LAMOZZO

wall light; plastic, white / plastic, transparent
Wandleuchte; Kunststoff, weiss / Kunststoff, transparent
Applique; plastique, blanc / plastique, transparent

L 140, H 210, A 110

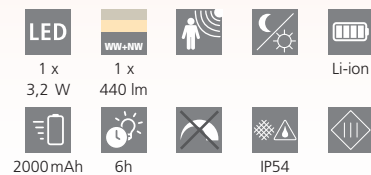

9 002759 987572



900255 LAMOZZO

wall light; plastic, black / plastic, transparent
Wandleuchte; Kunststoff, schwarz / Kunststoff, transparent
Applique; plastique, noir / plastique, transparent

L 140, H 210, A 110



9 008606 231287





48944



120°, 5 m

**SAFETY &
COMFORT**



90497



48944 PORRASSA

solar light; plastic, black / plastic, white
Solarleuchte; Kunststoff, schwarz / Kunststoff, weiss
luminaire solaire; plastique, noir / plastique, blanc

L 155, H 75, A 100



40 x
0,5 W



40 x
800 lm



Li-ion



2000mAh



6 - 8h



IP44



9 002759 489441



90497 ORIMINI

solar light; stainless steel, stainless steel
Solarleuchte; Edelstahl, edelstahl
luminaire solaire; acier inoxydable, acier inoxydable

L 200, H 300, A 40



2 x
0,06 W



neutral
WHITE



AA,
Ni-Mh



200mAh



6 - 8h



9 002759 904975



3x

0-9

1x

a-f

90497

Letters and numbers included in delivery.

Buchstaben und Zahlen im Lieferumfang enthalten.

Les lettres et les nombres sont inclus dans la livraison.



901085

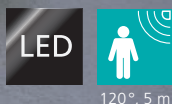

120°, 5 m

**SAFETY &
COMFORT**



901086



120°, 5 m

**SAFETY &
COMFORT**



* except / außer / except 98195, 98196

901085 PANETTIERI

solar light; plastic, black / plastic, white
Solarleuchte; Kunststoff, schwarz / Kunststoff, weiss
luminaire solaire; plastique, noir / plastique, blanc

L 145, H 170, A 30

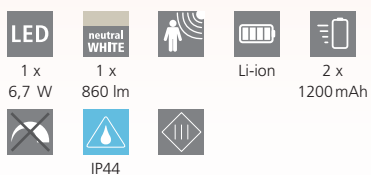

901086 PANETTIERI

solar light; plastic, black / plastic, white
Solarleuchte; Kunststoff, schwarz / Kunststoff, weiss
luminaire solaire; plastique, noir / plastique, blanc

L 145, H 170, A 30

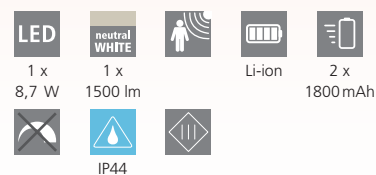



98196



140°, 9 m
3 sec. - 7 min.

SAFETY & COMFORT



98195



140°, 9 m
3 sec. - 7 min.

SAFETY & COMFORT

98196 CASABAS

wall light; plastic, white / plastic, white
Wandleuchte; Kunststoff, weiss / Kunststoff, weiss
Applique; plastique, blanc / plastique, blanc

L 115, H 155, A 130



1 x
5 W



1 x
470 lm



Li-ion



1800mAh



IP44



9 002759 981969



98195 CASABAS

wall light; plastic, black / plastic, white
Wandleuchte; Kunststoff, schwarz / Kunststoff, weiss
Applique; plastique, noir / plastique, blanc

L 115, H 155, A 130



1 x
5 W



1 x
470 lm



Li-ion



1800mAh



IP44



9 002759 981952





901069

LED

INCL./INKL./INCLUS



901069

This luminaire can change the light settings from warm white to RGB by remote control.

Diese Leuchten können per Fernbedienung die Lichteinstellungen von Warmweiß zu RGB wechseln.

Ces luminaires peuvent changer les réglages d'éclairage du blanc chaud au RGB par télécommande.



DESIGN
HIGHLIGHT
DETAIL





48719

LED



SET OF
3

48504

LED

901069 SAMBUCO

solar light; plastic, black
Solarleuchte; Kunststoff, schwarz
luminaire solaire; plastique, noir

L 175, B 100, H 375

LED

1 x
3 W

warm
WHITE

1 x
230 lm



Remote



IP44



L 175



H 375



9 008606 297962

48719 GIONATA

solar light; plastic, black
Solarleuchte; Kunststoff, schwarz
luminaire solaire; plastique, noir

L 75, B 110, H 115, ET 125

LED

1 x
0,1 W

neutral
WHITE

12



AA,
Ni-Mh



1000mAh



6 - 8h



12



12

L 75



H 115



9 002759 487195

48504 GIONATA 1

solar light; plastic, black
Solarleuchte; Kunststoff, schwarz
luminaire solaire; plastique, noir

L 165, B 95, H 220

LED

3 x
0,24 W

warm
WHITE

6 - 8h



AA,
Ni-Mh



3 x
200mAh



6 - 8h



6 - 8h

L 165



H 220



9 002759 485047



SET OF
6

48902

LED



SET OF
6

48494

LED

48902 ROSALBA

solar light; stainless steel, plastic, black
Solarleuchte; Edelstahl, Kunststoff, schwarz
luminaire solaire; acier inoxydable, plastique, noir

H 310, Ø 47, ET 100

LED

6 x
0,06W

6-8h

neutral
WHITE

7

2,3AAA,
Ni-Mh

100mAh

Ø 47



H 310



9 002759 489021

48494 ROSALBA 1

solar light; stainless steel, stainless steel / plastic, white
Solarleuchte; Edelstahl, edelstahl / Kunststoff, weiss
luminaire solaire; acier inoxydable, acier inoxydable / plastique, blanc

H 280, Ø 60, ET 105

LED

6 x
0,06W

6-8h

warm
WHITE

7

AAA,
Ni-Mh

100mAh

Ø 60



H 280



9 002759 484941



48505

LED



90494

LED

48505 STAZZONE

solar light; plastic, grey
Solarleuchte; Kunststoff, grau
luminaire solaire; plastique, gris

L 135, B 105, H 110

LED

warm
WHITE



3 x
0,06W

AA,
Ni-Mh 600mAh



6h



9 002759 485054



L 135

H 110

90494 STAZZONE

solar light; plastic, grey
Solarleuchte; Kunststoff, grau
luminaire solaire; plastique, gris

L 135, B 105, H 110

LED

warm
WHITE



4 x
0,06W

AA,
Ni-Mh 600mAh



6h



9 002759 904944



L 135

H 110



22441

LED



22442

LED



22443

LED

22441 PUGLIA

solar light; plastic, black / plastic, white
Solarleuchte; Kunststoff, schwarz / Kunststoff, weiss
luminaire solaire; plastique, noir / plastique, blanc

22442 PUGLIA

solar light; plastic, black / plastic, white
Solarleuchte; Kunststoff, schwarz / Kunststoff, weiss
luminaire solaire; plastique, noir / plastique, blanc

22443 PUGLIA

solar light; plastic, black / plastic, white
Solarleuchte; Kunststoff, schwarz / Kunststoff, weiss
luminaire solaire; plastique, noir / plastique, blanc

H 340, Ø 150, ET 100

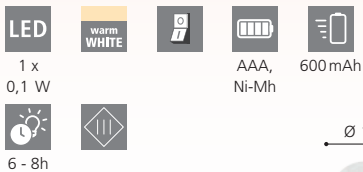

H 400, Ø 200, ET 100

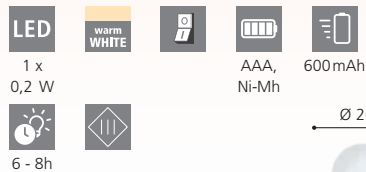

H 500, Ø 250, ET 100

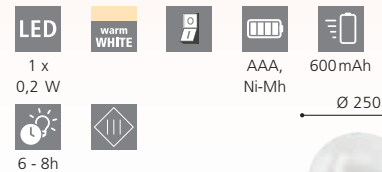

SET OF
3



48483

LED

48483 PUGLIA

solar light; plastic, black / plastic, white

Solarleuchte; Kunststoff, schwarz / Kunststoff, weiss

luminaire solaire; plastique, noir / plastique, blanc

LED

1 x
0,1 W



warm
WHITE

1 x
0,2 W



AAA,
Ni-Mh

LED

1 x
0,2 W



3 x
600mAh

warm
WHITE

1 x
0,2W



6 - 8h

LED

1 x
0,2W



warm
WHITE



HOW TO READ

ERKLÄRUNG

COMMENT LIRE

SENSOR INCLUDED
SENSOR INKLUDIERT
SENSOR INCLUS

This symbol indicates luminaires with a sensor. In addition the Detection angle, Reach, Time setting (min./max.) and Response brightness (lx) is indicated.

Ist die Leuchte mit einem Sensor ausgestattet, wird dies durch ein Sensorsymbol gekennzeichnet. Zusätzlich werden Erfassungswinkel, Reichweite, Zeiteinstellung (max./min.) und die Ansprechhelligkeit (lx) angegeben.

Un produit avec cette symbole ont une détecteur de mouvement. Aussi le angle de détection, la minuterie et Luminosité de déclenchement (lx) sont indiqués.

SERIES NAME
SERIENNAME
NOM DE LA SÉRIE

ARTICLE NUMBER
ARTIKELNUMMER
NUMÉRO D'ARTICLE

DESCRIPTION
BESCHREIBUNG
DESCRIPTION

The product description is composed as follows:
luminaire type; enclosure material, enclosure colour / glass or shade material, glass or shade colour

Die Produktbeschreibung setzt sich wie folgt zusammen:
Leuchtenart; Gehäusematerial, Gehäusefarbe / Schirm- bzw. Glasmaterial, Schirm- bzw. Glasfarbe

La description du produit est composée comme suit:
type de luminaire; matériel de boîtier, couleur de boîtier / matériel de verre ou abat-jour, couleur de verre ou abat-jour

DIMENSIONS
DIMENSIONEN
DIMENSIONS

all dimensions in mm | alle Größen in mm | toutes dimensions en mm

L = length | Länge | longueur

B = width | Breite | largeur

H = height | Höhe | hauteur

∅ = diameter | Durchmesser | diamètre

A = projection length | Ausladung | amplitude

ET = installation depth | Einbautiefe | profondeur utile

Base = base dimensions | Sockelmaße | dimensions de base

Attention! The dimensions relate solely to the sizes of the luminaire.
Any air spaces that would be relevant for a safe operating of the lamp were not considered.

Achtung! Die Größen beziehen sich nur auf die Abmessungen der Leuchte. Etwaige Lufträume, die für einen sicheren Betrieb der Leuchte notwendig sind, werden nicht berücksichtigt.

Attention! Les dimensions se réfèrent à la taille de la lampe seulement. Espacements éventuels, que seraient importants pour une opération de la lampe sans danger, n'ont pas été considérés.

900137 ALAMONTE 3
wall light; aluminum, steel, black
Wandleuchte; Alu, Stahl, schwarz
Applique; aluminium, acier, noir

900138 ALAMONTE 3
pedestal light; aluminum, steel, black
Sockelleuchte; Alu, Stahl, schwarz
luminaire pour socle; aluminium, acier, noir

900139 ALAMONTE 3
floor light; aluminum, steel, black
Standleuchte; Alu, Stahl, schwarz
lampadaire; aluminium, acier, noir

L 170, H 295, A 100
E27 1 x 60 W IP44

L 150, B 150, H 450
E27 1 x 60 W IP44

L 150, B 150, H 1000
E27 1 x 60 W IP44

9 008606 230112
9 008606 230129
9 008606 230136

A 100
H 295
L 170
H 450
L 150
H 1000
L 150

TIMELESS
84

SKETCHES
SKIZZEN
CROQUIS

The sketches state the most meaningful dimensions. If a product is adjustable by will, a turquoise arrow marks this function and only the maximum dimensions are indicated.

Die Bemaßung der Skizzen umfasst jeweils die aussagekräftigsten Größen. Bei verstellbaren Produkten kennzeichnet ein türkiser Pfeil diese Funktion und nur die maximalen Größen werden angegeben.

Les dimensions des croquis comprennent les plus représentatives. Si un produit est réglable au choix, une flèche turquoise affiche cette fonction et rien que les dimensions maximales sont indiquées.

PRODUCT IN THE AMBIANCE
PRODUKTE IM AMBIENTE
PRODUITS DANS L'AMBIENCE

You can find the article number next to each product in the ambiance pictures.
Sie finden die Artikelnummer neben jeder Abbildung des Produktes auf unseren Ambientebildern.
Vous pouvez trouver le numéro d'article à côté de chaque produit dans les images de l'ambiance.



900136 ALAMONTE 3

wall light; aluminium, steel, black
Wandleuchte; Alu, Stahl, schwarz
Appareil; aluminium, acier, noir

L 170, H 260, A 100



TIMELESS
85

PICTOGRAMMES
PIKTOGRAMME
PICTOGRAMMES

Technical details are represented as pictograms. An overview over all pictograms can be found on the next pages.

Technische Details werden als Piktogramme dargestellt. Eine Übersicht über alle Piktogramme finden Sie auf den nächsten Seiten.

Les détails techniques sont représentés sous forme de pictogrammes. Vous trouverez un aperçu de tous les pictogrammes dans les pages suivantes.

ENERGY EFFICIENCY LABELS
ENERGIEEFFIZIENZ-LABEL
LABEL DE L'EFFICACITÉ ÉNERGÉTIQUE

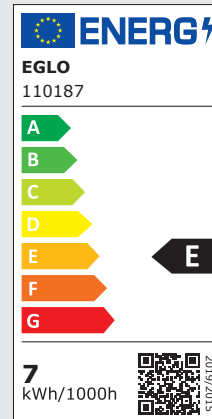

The new energy label must be indicated on all light sources with a luminous flux between 60 and 82,000 lumens and OLED. This applies to lamps, LED modules and luminaires where the light source cannot be removed without destroying it.

Das neue Energielabel muss auf allen Lichtquellen mit einem Lichtstrom zwischen 60 und 82.000 Lumen und OLED angegeben werden. Dies gilt für Lampen, LED-Module und Leuchten, bei denen die Lichtquelle nicht zerstörungsfrei entnommen werden kann.

Le nouveau label énergétique doit être indiqué sur toutes les sources lumineuses dont le flux lumineux est compris entre 60 et 82 000 lumens et sur les OLED. Cela s'applique aux lampes, aux modules LED et aux luminaires dont la source lumineuse ne peut être retirée sans être détruite.

The information on the label includes: / Die Angaben auf dem Etikett beinhalten: / Les informations figurant sur l'étiquette sont les suivantes :

- › Name/Trademark
Name/Warenzeichen
Nom/marque de commerce
- › Model / Modell / Modèle
- › Energy label scale A-G / Energielabel-Skala A-G / Échelle d'étiquetage énergétique A-G
- › Energy consumption for 1,000 hours of use/
Energieverbrauch bei 1.000 Stunden Nutzung/
Consommation d'énergie pour 1 000 heures d'utilisation
- › Energy efficiency class of the product/
Energieeffizienzklasse des Produkts/
Classe d'efficacité énergétique du produit
- › QR Code to EPREL (Product Database of the European Product Registry for Energylabelling)/
QR Code zur EPREL (Produktdatenbank der European Product Registry for Energylabelling)/
Code QR pour EPREL (base de données des produits du registre européen des produits pour l'étiquetage énergétique)

The energy spectrum ranges from G to A.
Das Energiespektrum reicht von G bis A.
Le spectre énergétique va de G à A.

EGLO WORLDWIDE – SALES COMPANIES

EGLO WELTWEIT – VERTRIEBSGESELLSCHAFTEN

EGLO WORLDWIDE – SOCIÉTÉS DE VENTE



 **AUSTRIA**
EGLO LEUCHTEN GMBH
Heiligkreuz 22
6136 Pill
T: +43 5242 6996 110 | F: +43 5242 6996 972
info-austria@eglo.com

 **CHILE**
EGLO CHILE ILUMINACIÓN LTDA.
Av. Américo Vespucio Norte 1930
Conchalí - Santiago de Chile
T: +562 2 595 2222
info-chile@eglo.com

 **DENMARK**
EGLO DANMARK A/S
Agerbakken 20
8362 Hørring
T: +45 70 22 55 11
info-denmark@eglo.com

 **AUSTRALIA**
EGLO LIGHTING AUSTRALIA
5/339 Archerfield Road
4077 Richlands | Queensland
T: +61 7 3375 1413 | F: +61 7 3375 1412
info@eglighting.com.au

 **CHINA**
DONGGUAN EGLO LIGHTING
COMMERCIAL CO LTD
No.1 | Shangqiao Industrial Rd Shangqiao, Dongcheng
Dongguancity, Guanzhouprovince
T: +86 769 2203 3866 | F: +86 769 2203 6866
info-china@eglo.com

 **ESTONIA**
MOODNE VALGUSTUS AS
Rävala pst. 7
10143 Tallinn
T: +372 667 6670 | F: +372 631 3195
info-estonia@eglo.com

 **BELGIUM**
EGLO BELGIUM BV
Antwerpsesteenweg 247
2950 Kapellen
T: +32 3 250 60 80 | F: +32 3 219 80 67
info-belgium@eglo.com

 **COLOMBIA**
EGLO COLOMBIA ILUMINACIÓN SAS
Autopista Norte 800 Mts adelante del Peaje de los Andes
Costado Oriental Km 19 Lote 30
Bogotá - Chia
T: +57 (1) 744 2339
info-colombia@eglo.com

 **FINLAND**
EGLO FINLAND OY
Malmin raitti 17A
00700 Helsinki
T: +358 20 7649 820
info-finland@eglo.com

 **BOSNIA AND HERZEGOVINA**
EGLO RASVJETA BH D.O.O.
Hrgovi Donji 178
76250 Gradacac
T: +387 35 86 85 00 | F: +387 35 82 44 41
info-Bosnia-Herzegovina@eglo.com | info@eglo.ba

 **COSTA RICA**
EGLO COSTA RICA
Centro Comercial Calle Real local #8 de la sucursal del
BAC San José 800 metros al norte Guachipilín de Escazú
San José, Costa Rica
T: +506-2289-4690 | F: +506-2100-6384
info-costarica@eglo.com

 **FRANCE**
EGLO FRANCE LUMINAIRE SARL
Z.A. Jeune Bois | 2 Rue de la Martinique
68274 Wittenheim
T: +33 3 89 62 50 45 | F: +33 389 6250 49
info-france@eglo.com

 **BULGARIA**
EGLO BULGARIA EOOD
Main Road Burgas-Sofia | 5th kilometer | Building EGLO
8000 Burgas
T: +359 888 755 509
info-bulgaria@eglo.com

 **CROATIA**
EGLO RASVJETA D.O.O.
Jadranska avenija 9
10020 Zagreb
T: +385 1 379 40 62 | F: +385 1 379 41 04
info-croatia@eglo.com

 **GERMANY**
EGLO LEUCHTEN HANDELS GMBH
Kleinbahnstr. 35
59759 Arnsberg
T: +49 2932 6269 0 | F: +49 2932 6269 39
info-germany@eglo.com

 **CANADA**
EGLO CANADA INC.
20700 Route Transcanadienne
H9X 4B7 Baie D'Ufré, Quebec
T: +1 514 457 5483 | F: +1 514 457 5487
info-canada@eglo.com

 **CZECH REPUBLIC**
EGLO CZ+SK s.r.o.
Náchodská 2479/63
193 00 Praha 9
T: +420 281 924 163 | F: +420 281 925 205
info-czechrepublic@eglo.com

 **GREAT BRITAIN AND IRELAND**
EGLO UK LTD.
54 Denington Rd, Denington Industrial Estate
Wellingborough NN8 2QH, UK
T: +44 1604 790 986
info-UK@eglo.com

**GREECE**
EGLO HELLAS A.E.

Sykias 2 and parodos dekeleias
13679 Acharnai
T: +30 21 0800 2363
info-greece@eglo.com

**MIDDLE EAST**
EGLO LIGHTING MIDDLE EAST FZE

P.O. BOX 262073, LOB6, OFFICE G18
Jebel Ali, Dubai, UAE
T: +97 148810080 | F: +97 148810081
gulf@eglo.com

**SLOVAKIA**
EGLO CZ+SK s.r.o

Náchodská 2479/63
193 00 Praha 9
T: +421 313 211 551 | F: +421 313 211 556
info-slovakia@eglo.com

**HUNGARY**
EGLO LUX KFT.

Fó út 143/A
2120 Dunakeszi
T: +36 27 341 353
info-hungary@eglo.com

**MOROCCO - EGLO AFRICA**
EGLO MAGHREB LUMINAIRES SARL

219 Bd Med Zerktoni. Suite: 67
20330 Casablanca
T: +212 522 98 80 25 / -05
info-global@eglo.com | info.africa@eglo.com

**SLOVENIA**
EGLO RASVJETA D.O.O.

Jadranska avenija 9
10020 Zagreb
T: +386 158 093 18
info-slovenia@eglo.com

**INDIA**
EGLO INDIA PRIVATE LIMITED

A-307, Ansal Chambers - 1, 3, Bhikaji Cama Place,
110066 Delhi
T: +91 85279 44288
info-india@eglo.com

**THE NETHERLANDS**
EGLO VERLICHTING NEDERLAND B.V.

Innovatiepark 20
4906 AA Oosterhout (NB)
T: +31 162 48 28 30
info-nl@eglo.com

**SPAIN**
EGLO ESPANA ILUMINACIÓN S.L.

Avda. de Castilla,1 (Edf. Best Point) 2º Planta - Oficina
16A-B
28830 San Fernando de Henares, Madrid
T: +34 91 677 90 44 | F: +34 91 677 03 04
info-spain@eglo.com

**ITALY**
EGLO ITALIANA S.R.L.

Via Giotto, 4
31021 Mogliano Veneto (TV)
T: +39 041 45 66 245 | F: +39 041 45 74 066 / 071
info-italy@eglo.com

**NORWAY**
MS BELYSNING

Gardermovegen 95B
2030 Nannestad
T: +47 63 888500 | F: +47 63 888501
info-norway@eglo.com

**SWEDEN**
EGLO SVRIGE AB

Star Street 1
512 50 Svenljunga
T: +46 340 623 505
info-sweden@eglo.com

**KAZAKHSTAN**
EGLO KAZAKHSTAN LLP

Al-Farabi Avenue 7, Office 72, 14rd floor, Block 4A,
Nurlı-Tau Business Center
50059 Almaty
T: +7 727 293 25 20 | M: +7 701 031 00 00
info-kazakhstan@eglo.com

**PERU**
EGLO PERU S.A.C

Av Primavera 1419
Distrito de Santiago de Surco y Departamento de Lima
T: +51 902 763 635
info-peru@eglo.com

**SWITZERLAND**
EGLO SCHWEIZ AG

Seetalstrasse 142
6032 Emmen
T: +41 41 268 69 59
info-switzerland@eglo.com

**KOSOVO**
EGLO KOSOVA LLC

Lugisht e qytetit pn
20000 Prizren
T: +383 44 216 687 | SHOP: +383 49 699 100
info-kosovo@eglo.com

**POLAND**
EGLO POLSKA SP. Z O.O.

Ul. Dżwiękowa 2
02-857 Warszawa
T: +48 22 644 57 55 | T: +48 22 644 89 82
info-poland@eglo.com

**TURKEY**
EGLO Aydınlatma ithalat İhracat Ltd. Şti.

Eyüp Sultan Mah. Sekmen Cad. No:18/2
34885 Sancaktepe / İstanbul Samandıra
T: +90 216 311 09 -02 / -03 / -04 |
F: +90 216 311 09 / -05
info-turkey@eglo.com

**LATVIA**
MOODNE VALGUSTUS AS

Rävala pst.7
10143 Tallinn
T: +370 652 49923 | T: +372 667 6670
info-latvia@eglo.com

**PORTUGAL**
EGLO PORTUGAL ILUMINAÇÃO, LDA

Rua Fonte Parada, 125
4595-434 Seroa-Paços de Ferreira
T: +351 255 890 000
info-portugal@eglo.com

**UKRAINE**
EGLO UKRAINE LTD

Vatslava Gavela boulevard, 6/7-A,
03124 Kyiv
T: +38 067 670 58 61
info-ukraine@eglo.com

**LITHUANIA**
MOODNE VALGUSTUS AS

Rävala pst.7
10143 Tallinn
T: +370 652 49923 | T: +372 667 6670
info-lithuania@eglo.com

**ROMANIA**
EGLO ROMANIA PRODEXIM SRL.

Str. Atomistilor nr. 1D
77125 Magurele - Ilfov
T: +40 314 250 902 | F: +40 314 250 899
info-romania@eglo.com

**USA**
EGLO USA, INC.

3640 Royal South Parkway
30349 Atlanta, Georgia
T: +1 404 477 5601 | F: +1 404 393 7053
info-usa@eglo.com

**MALAYSIA**
EGLO ASIA SDN BHD

B-07-13, Empire Soho, Empire Subang, Jalan SS 16/1,
47500 Subang Jaya, Selangor Darul Ehsan.
T: +60162115313
info-malaysia@eglo.com

**RUSSIA**
EGLO LIGHTING LLC

Varshavskoe shosse 3 | Office 23
117105 Moscow
T: +7495 789 4311 | F: +7495 789 4312
info-russia@eglo.com

**MEXICO**
EGLO MÉXICO ILUMINACIÓN S DE RL DE CV

Prolongación Avenida López Mateos Sur N°3561,
Fraccionamiento Los Gavilanes
C.P. 45645 Tlajomulco de Zúñiga | Jalisco
T: +52 33 3687 20 95
info-mexico@eglo.com













**SERBIA**
EGLO RASVETA DOO

Stefana Prvovenčanog 28
11000 Beograd
T: +381 11 3981 366 | F: +381 11 3981 389
info-serbia@eglo.com

LEGEND

PICTOGRAM PIKTOGRAMME PICTOGRAMME

SOCKETS FASSUNGEN DOUILLES

 LED	 G9	 GX53
 E14	 G13	 GY6,35
 E27	 G23	 R7s
 G4	 GU5,3 / MR16	
 G5	 GU10	

BULBS LEUCHTMITTEL AMPOULES

 E14 / C35	 E27 / A60 Filament	 E27 / T32 Filament
 E14 / C35f	 E27 / A65 LED	 G4 / T9
 E14 / D45	 E27 / A75 Filament	 G4 / LT9
 E14 / C35f LED	 E27 / G45 LED	 G4 / LT14
 E14 / C35 Halogen	 E27 / G45 Filament	 G9
 E14 / T22	 E27 / G80 Filament	 G9 LED
 E14 / C35 Filament	 E27 / G95	 GU10
 E14 / C37 Filament	 E27 / G95 Filament	 GU10 LED
 E14 / C35f Filament	 E27 / G125	 GU10 SMD LED
 E14 / C37f Filament	 E27 / G95 LED	 GX53 / LF75
 E14 / P45 LED	 E27 / G200 Filament	LED LED board / LED Platine / LED bord
 E14 / P45 Filament	 E27 / R63 LED	 MR16
 E14 / P50	 E27 / ST48 Filament	 MR16 LED
 E14 / ST48 Filament	 E27 / ST64 Filament	 R7s / 78mm
 E14 / ST64 Filament	 E27 / B80 Filament	 R7s / 118mm
 E14 / T20 LED	 E27 / BR150 Filament	 R7s / 78mm LED
 E27 / A60	 E27 / DP165 Filament	 R7s / 118mm LED
 E27 / G90	 E27 / E140 Filament	
 E27 / QR63	 E27 / PS160 Filament	
 E27 / A60 LED	 E27 / T30 Filament	

LIGHT COLOUR & LUMEN
LICHTFARBE & LUMEN
COULEUR LUMINEUX & LUMEN

The colours of the LED are represented as pictogrammes (see below), their luminous flux directly beneath. The luminous flux is quoted in lumen and describes the amount of light generated by the LED. The higher the value, the brighter is the lamp. Lumens are LED boards and are the light measurement value in bulbs.

Die Farben der LED werden als Piktogramm (siehe unten) dargestellt, deren Lichtstrom direkt darunter. Der Lichtstrom wird in Lumen gemessen und gibt die erzeugte Lichtmenge der LED an. Je höher der Wert, desto heller das Produkt. Lichtstromangaben (Lumen) sind Platinen- bzw. Leuchtmittelwerte.

Les couleurs de LED ont représentés sous forme de pictogrammes, leur flux lumineux directement en dessous. L'unité de flux lumineux est le lumen et il mesure la quantité de lumière générée par les LED. Plus la valeur est élevée, plus la lampe est lumineuse. Les lumens sont l'unité de mesure de l'intensité lumineuse des ampoules et des panneaux led intégrés.

	RGB RGB RGB		RGB + tunable white RGB + tunable white RGB + tunable white		neutral white neutralweiß blanc neutre
	RGB + white RGB + weiß RGB + blanc		tunable white tunable white tunable white		
	RGB + warmwhite RGB + warmweiß RGB + blanc chaud		warm white warmweiß blanc chaud		
	RGB + coldwhite RGB + kaltweiß RGB + blanc froid		cold white kaltweiß blanc froid		
	RGB + neutralwhite RGB + neutralweiß RGB + blanc neutral		neutral white neutralweiß blanc neutre		

SWITCHES & SENSORS
SCHALTER & SENSOREN
INTERRUPTEUR & CAPTEURS

	incl. cable & plug inkl. Kabel & Stecker câble & connecteur inclus		pedal switch Trittschalter interrupteur à pied		swedish plug Stecker Schweden connecteur swede
	internal dimmer eingebauter Dimmer variateur intégré		cable switch Kabelschalter interrupteur à câble		"Touch me" ON/OFF "Touch me" EIN/AUS "Touch me" ON/OFF
	button switch Druckknopf interrupteur de pression		incl. cable & plug transformer inkl. Kabel & Stecktransformator câble & transformateur à prise		"Touch me" ON/OFF & dimm "Touch me" EIN/AUS & Dimmen "Touch me" ON/OFF & graduable
	function switch Funktionsschalter interrupteur fonction		remote control Fernbedienung télécommande		pull switch Zugschalter interrupteur à bascule
	rocker switch Wippschalter interrupteur à bascule		Day & Night Sensor Tag & Nacht Sensor sensor jour & nuit		Timer - automatic on/off Zeitschaltuhr - automatisches Ein- & Ausschalten minuterie - peut être éteint et allumé automatiquement
	pedal dimmer Trittdimmer variateur à pied		sensor Sensor sensor		

FUNKTIONS & COMFORT
FUNKTIONEN & KOMFORT
FONCTIONS & COMFORT

	incl. battery inkl. Akku incl. pile		dimmmable dimmmbar mit externen Dimmer graduabile		Voltage Volt Voltage		Touchless Sensor Berührungsloser Sensor Capteur sans contact
	incl. battery inkl. Batterie incl. pile		not dimmmable nicht dimmmbar ne pas graduabile		Watt		CCT Switch CCT Schalter Interrupteur CCT
	battery specifications Batteriespezifikationen spécifications des piles		Can be operated via control unit Bedienbar über Steuergerät Peut être commandé par une unité de contrôle		USB connection USB-Anschluss Connexion USB		Emergency Luminaire Notfall Licht Lumière d'urgence
	beam angle Ausstrahlwinkel angle de rayonnement		replaceable LED austauschbare LED LED remplaçables		Qi-Charger		Height adjustable electric Höhenverstellbar elektrisch Réglable en hauteur, électrique
	corner mount possible Eckmontage möglich montage en coin possible		loadable in kg belastbar in kg chargeable en kg		possible ceiling angle mögliche Deckenschräge angle de plafond possible		Height adjustable manual Höhenverstellbar manuell Réglage manuel de la hauteur
	Colour Rendering Index		packaging / delivery unit Verpackungs- / Liefereinheit unité d'emballage / de livraison		max. airflow m3/h max. Luftstrom m3/h max. débit m3/h		
	cutout (in mm) Ausschnitt (in mm) perçage du panneau (en mm)		shortable kürzbar réductible		Motor type Motortyp Type de moteur		

PROTECTION CLASS
SCHUTZKLASSE
CLASSE DE PROTECTION

The protection class indicates to what extent the lamp is protected against electric shock. All lamps in this catalogue are at least protected with the protection class 1 - a higher class is specified in the information box of the respective lamp.

Die Schutzklasse gibt an, inwiefern ein Produkt gegen einen elektrischen Schlag gesichert ist. Alle Leuchten in diesem Katalog sind mit mindestens Schutzklasse 1 gesichert, bei höheren Klassen wird das Symbol im Infokasten der Leuchte angegeben.

La classe de protection indique, dans quelle mesure la lampe est protégée contre les chocs électriques. Tous les lampes dans ce catalogue sont protégées au moins avec la classe 1 - une classe plus élevée est indiquée dans l'information de la lampe.

	protection class 1: protective earthing Schutzklasse 1: Schutzerdung classe de protection 1: prise de terre		protection class 2: protective insulation Schutzklasse 2: Schutzisolation classe de protection 2: double isolation ou renforcée		protection class 3: protective low voltage Schutzklasse 3: Schutzkleinspannung classe de protection 3: très basse tension de sécurité
--	---	--	---	--	---

PROTECTION RATING
SCHUTZGRAD
INDICE DE PROTECTION

The protection rating ensures the operational safety of luminaires. The first number specifies the extent of the protection against the ingress of foreign bodies; the second number identifies the humidity protection grade. All luminaires in this catalogue are at least protected with the rating IP20 - a higher rating is specified in the information box of the luminaire.

Der Schutzgrad gewährleistet die Betriebssicherheit von Leuchten. Die erste Ziffer des IP Grades beschreibt den Schutzzumfang gegen das Eindringen von Fremdkörpern, die zweite Ziffer informiert über den Grad des Feuchtigkeitsschutzes. Alle Leuchten in diesem Katalog sind mit mindestens Schutzgrad IP20 gesichert, bei höheren Graden wird das Symbol im Infokasten der Leuchte angegeben.

L'indice de protection assure la sécurité opérationnelle des luminaires. Le premier chiffre indique à quel point la protection est efficace contre l'insertion de corps étrangers; le second chiffre indique quant à lui le degré de protection par rapport à l'humidité. Tous les luminaires dans ce catalogue sont protégés au moins avec l'indice IP20 - un indice plus élevé est indiqué dans l'information d'article.

	IP33		IP44		IP54		IP65		IP67
--	------	--	------	--	------	--	------	--	------

REGISTER

SERIES NAMES
SERIENNAMEN
NOME DE PRODUITS

name name nom	page seite page	name name nom	page seite page	name name nom	page seite page	name name nom	page seite page
AGOLADA	106	CHINOA	70	JORBA	118	PANTETE	215
ALAMONTE	86	CISTIerna	104-105	KIBEA	72	PARK	123
ALAMONTE 1	86-89	CITY	126-127	LAMEDO	194	PARK 4	200-201
ALAMONTE 3	84-85	CONNECT Z REMOTE	24	LAMOZZO	220	PARK 5	202
ALBACETE	161	CONNECT-Z SENSOR	24	LATERNA 4	170-172	PASTION	218
ALMONTE SMOKE	89	CONNECTOR BOX	201	LATERNA 5	174-175	PORRASSA	221
ALORIA	162-163	CORBEZZOLA	219	LESMO	73	PRATA VECCHIA	142
ALTILIA	212	CORNALE	138	LISIO	152	PREDAZZO	72
APPRODO	130-131	COSTORIO	77	LM_LED_E27	32-33, 198	PUGLIA	228-229
ARGOLIS 2	128-129	CROARA	218	LM_LED_GU10	32	PULFERO 1	161
ARGOLIS-Z	26	CUBA	204	MADRIZ	140	RAVELLO	58
ATOLLARI	103	DARFANO	217	MANFRIA	43	REDONDO	71
AZZINANO	141	DESELLA 1	118	MARGIDORE	131	RIFORANO	40-41
BARACCONI	216	DETECT ME 1	192-193	MARGO	197	RIGA	100-101
BASALGO-Z	29	DETECT ME 3	192-193	MARTANO	219	RIGA 3	194
BELCREDA	70	DETECT ME 6	192-193	MARUGGIO	113	RIGA 5	102-103
BEVERLY	105	DONATORI	155	MELGOA	160	RIGA-LED	107
BITETTO	77	DONINNI 1	44-45	MELZO	46	RIGOSA	48
BOVOLONE	155	DREOLI	210	MILTON	159	ROBLEDO	105
BREGANZO 1	123	EREMITANA	111	MINERARIO	132-135	ROSALBA	226
BRIANZA	75	EREMITANA-Z	27	MIRANDOLA	156	ROSALBA 1	226
BRISCOLA	68-69	FAEDO 3	184-191	MONTARELLO	68-69	SAKEDA	118
BUDRONE	79	FAEDO 4	181	MONTEROLO	144	SALITTA	62
BUFALATA	76	FANDINA	64	MONTEROLO-Z	28	SALLE	92
CALDIERO	52	FARINDOLA	75	MORINO	71	SAMBUCO	225
CALPINO	114	FIUMICINO	50-51	MUSSOTTO	141	SAN TELMO	160
CALPINO 2	114	FLATNEON Z	30	NAVEDO	164-166, 168-169	SANIA-Z	27
CALPINO 3	115-117	FORNACI	55	NEMA	180	SELINUS	59
CAMARDA	120-121	GIONATA	225	NEMA 1	180	SERRICELLA	64
CANOVE	159	GIONATA 1	225	NEMBRO	43	SESIMBA 1	73
CARRARO	154	GORZANO	75	NEVIANO	63	SIDNEY	151
CASABAS	223	GRUTTI	110	NINNARELLA	54	SIRMIONE	150
CASCINETTA	90	HELSINKI	95-97	NIVAROLO	55	SONCINO	156
CASTAGNETO	136-137	HILBURN	157	ONJA	176	SONELLA	138
CASTAGNETO-M	137	HILBURN 1	157	ORIMINI	221	SPIANTE	216
CERNO	124-125	IPHIAS 2	128	PAGINO	182	SPONGANO	112
CERRISI	210	IZZALINI	108	PALOSCO	52	STAGNONE	53
CHIAPPERA	56	JABAGA	111	PANETTIERI	222	STAZZONE	227

name name nom	page seite page
STIAPPA	220
STOCKHOLM 1	124
SUZZARA	219
TAPARITA	64
TAVERNA	142
TOMELLOSO	98-99
TORRECOLA	109
TRECCATE	156
TREVILOLO	73
TRIBANO	123
UGENTO	61
UTRERA	218
VALDEO	157, 161
VASCELLA	66-67
VENTO 1	139
VENTO 2	139
VERDOLINO	68-69
VERRES	141
VILLAGRAZIA	65
VOSCARI	217
ZANCARO	145
ZANCARO 1	145
ZIMBA	197
ZIMBA-LED	197



REGISTER

ARTICLE NUMBER

ARTIKELNUMMER

NUMÉROS D'ARTICLE

Number nummer Numéro	page seite page	Number nummer Numéro	page seite page	Number nummer Numéro	page seite page	Number nummer Numéro	page seite page	Number nummer Numéro	page seite page	Number nummer Numéro	page seite page	Number nummer Numéro	page seite page
12235	33	83279	97	93465	166	97261	155	98701	155	900257	187	900887	112
12241	33	83281	97	93481	194	97284	123	98707	75	900258	29	900888	113
12251	32	83433	123	93482	194	97285	150	98709	70	900261	62	900889	113
12253	32	83589	159	93994	72	97287	150	98711	70	900262	62	900891	113
22144	172	83966	151	94093	197	97288	150	98713	90	900268	28	900985	95
22145	172	83971	151	94101	101	97289	138	98714	90	900269	28	900986	95
22441	228	86189	194	94102	101	97294	156	98715	90	900271	28	900987	95
22442	228	86541	105	94103	100	97296	156	98719	156	900275	111	900992	61
22443	228	87105	151	94105	101	97303	46	98721	58	900276	111	900993	61
22462	174	88139	127	94106	100	97304	46	98723	58	900277	129	900995	108
22463	174	88142	126	94107	100	97312	70	98725	40	900278	128	900996	108
22464	174	88144	126	94111	180	97421	193	98726	41	900279	129	901025	110
22466	175	88152	204	94121	139	97422	192	98727	40	900281	128	901026	110
22467	170	88153	204	94788	88	97451	52	98728	40	900283	128	901028	109
22468	171	88489	159	94792	160	97455	184	98731	142	900285	154	901029	109
22469	171	88575	197	94803	106	97456	184	98738	52	900286	154	901031	202
22471	171	88744	204	94804	106	97457	184	98746	73	900287	56	901032	202
22472	172	89767	176	94831	86	97458	185	98751	43	900288	79	901033	92
22995	175	89768	176	94832	87	97459	186	98757	220	900289	79	901034	92
22996	175	90184	160	94833	88	97461	186	99099	24	900291	77	901035	92
30184	152	90494	227	94843	157	97462	186	99106	24	900292	73	901063	117
30185	152	90497	221	94855	161	97463	187	99565	125	900445	114	901064	116
30187	152	90748	200	94863	160	97464	193	99566	125	900669	76	901065	117
30191	124	91206	201	94866	157	97465	192	99567	127	900671	76	901066	117
30192	125	91207	201	94871	138	97471	181	99568	127	900672	59	901069	225
31566	89	92736	107	94872	138	97632	46	99569	102	900673	55	901071	210
32898	102	93095	163	95097	118	98085	105	99571	102	900674	55	901072	210
32899	103	93097	162	95235	197	98086	104	99584	140	900675	55	901073	212
33152	188	93098	162	96013	105	98096	43	99586	142	900676	63	901074	212
33153	189	93254	72	96018	123	98097	43	99587	86	900677	63	901075	212
33154	188	93268	124	96021	73	98101	144	99598	142	900678	63	901076	215
33155	188	93318	71	96239	157	98102	144	110186	198	900679	77	901077	215
33156	190	93319	71	96241	161	98103	144	110187	198	900681	64	901078	215
33157	191	93368	71	96256	118	98148	50	110189	198	900682	75	901079	210
33158	190	93384	180	96262	161	98149	50	110308	32	900684	59	901081	218
33159	190	93403	163	96276	103	98151	50	900118	64	900688	54	901082	216
33627	89	93407	162	96277	103	98152	51	900124	26	900689	54	901083	219
48483	229	93408	163	96287	118	98153	65	900126	26	900691	53	901084	220
48494	226	93426	201	96365	139	98154	65	900131	27	900692	53	901085	222
48504	225	93445	169	96452	193	98176	182	900133	64	900698	87	901086	222
48505	227	93447	169	96454	192	98178	182	900136	85	900709	61	901092	30
48719	225	93452	168	96505	107	98185	181	900137	84	900802	56	901095	30
48902	226	93454	168	97146	52	98191	218	900138	84	900803	56	901524	130
48944	221	93456	164	97159	141	98195	223	900139	84	900804	219	901525	130
48968	218	93457	164	97218	141	98196	223	900189	111	900807	120	901526	130
81751	96	93458	164	97222	75	98266	44	900243	219	900808	120	901527	131
81752	97	93459	165	97226	159	98269	44	900245	216	900809	120	901528	131
81753	96	93462	165	97238	141	98271	44	900246	216	900811	121	901529	131
82309	126	93463	166	97241	114	98272	45	900255	220	900885	112	901531	136
83278	96	93464	166	97242	114	98273	86	900256	185	900886	112	901532	136

Number
number
Numéro

page
seite
page

901533	136
901534	137
901535	137
901536	137
901572	132
901573	132
901574	132
901575	133
901576	134
901577	135
901578	135
901579	135
901839	48
901841	48
901842	48
901843	115
901844	115
901914	217
901916	217
901955	27
901956	27
902018	69
902019	68
902021	69
902022	68
902023	69
902024	68
902037	99
902038	98
902039	99
902041	99
902042	145
902043	145
902219	67
902221	66
902222	67
902223	66



All previous catalogues and price lists are no longer valid with the issue of this catalogue. Errors, misprints, model and price changes and technical modifications are reserved. We deliver based on our terms of delivery and payment. Our products comply with the European light norm EN60598. Products with the ENEC test mark are conforming to the guide line 2006/95/EG. Products with additional safety remarks (e.g protection class, IP) are identified within the product family with the relevant symbol and number. The content of this catalogue is protected under copyright law for EGLO Leuchten GmbH. All rights reserved. Our specific written consent must be obtained before using any illustrations and texts. The pictures are 4C prints and may differ from the original. The product pictures and ambiances in this catalogue can deviate from reality, and they do not necessarily concur with the usual application of the product. EGLO does not assume liability for the correctness, completeness or the application depiction of the products and/or the product information.

Design, layout and composition: EGLO Leuchten GmbH, A-6136 Pill - AUSTRIA
Print: Samson Druck GmbH, 5581 St. Margarethen - AUSTRIA
Pictures: EGLO, Adobe Stock, istockphoto.com

Mit diesem Katalog verlieren alle vorhergehenden Kataloge und Preislisten ihre Gültigkeit. Irrtümer, Druckfehler, Modell- und Preisänderungen sowie technische Änderungen vorbehalten. Wir liefern zu unseren Liefer- und Zahlungsbedingungen. Unsere Produkte entsprechen der europäischen Leuchtnorm EN 60598. Produkte mit dem ENEC Prüfzeichen sind konform mit der Richtlinie 2006/95/EG. Produkte mit weiteren Sicherheitshinweisen (zB. Schutzklasse, IP) sind mit Symbol und Zahl bei der Produktfamilie ausgezeichnet. Der Inhalt dieses Kataloges ist für die EGLO Leuchten GmbH urheberrechtlich geschützt. Alle Rechte sind vorbehalten. Bilder und Texte dürfen nicht ohne vorherige ausdrückliche, schriftliche Genehmigung verwendet werden. Die Abbildungen sind 4C Drucke und können vom Original abweichen.

Die Katalogbilder und die gezeigten Darstellungen der Produkte können von der Wirklichkeit abweichen und nicht den üblichen Produktanwendungen entsprechen. EGLO übernimmt keine Haftung für die Richtigkeit, Vollständigkeit und Anwendungsdarstellung der Produkte und Produktinformationen.

Gestaltung, Layout und Satz: EGLO Leuchten GmbH, A-6136 Pill - AUSTRIA
Druck: Samson Druck GmbH, 5581 St. Margarethen - AUSTRIA
Bilder: EGLO, Adobe Stock, istockphoto.com

Le présent catalogue remplace tous les catalogues et tarifs précédents. Sous réserve d'erreurs, de fautes d'impression, de modification des modèles et de changement de prix et de technique. Nous livrons sur la base de nos conditions de livraison et de paiement. Nos produits sont conformes aux normes européennes EN 60598 et portent le marquage CE. Les produits portant la marque ENEC sont conformes à la Directive 2006/95/EG. Les produits portant d'autres indications de sécurité (par exemple classe de protection, IP) sont identifiés par le symbole et le nombre correspondants dans la famille de produits.

Le contenu du présent catalogue est protégé pour la société EGLO Leuchten GmbH par un copyright. Tous droits réservés. Toute reproduction d'images et du texte est interdite sans autorisation explicite par écrit préalable. Les images sont imprimées en 4C et peuvent différer de l'original.

Les images des produits et les ambiances dans le catalogue peuvent dévier de la réalité et ne sont pas nécessairement en ligne avec l'usage habituel du produit. EGLO n'engage pas sa responsabilité sur la justesse des images et sur les informations relatives à l'usage pouvant être fait des produits.

Conception, maquette et composition: EGLO Leuchten GmbH, A-6136 Pill - AUSTRIA
Presse: Samson Druck GmbH, 5581 St. Margarethen - AUSTRIA
Images: EGLO, Adobe Stock, istockphoto.com

12-2024



printed according to the Austrian Ecolabel criteria for printed matter, UW-Nr. 837
gedruckt nach der Richtlinie "Druckerzeugnisse" des Österreichischen Umweltzeichens, UW-Nr. 837
imprimé selon la directive „Produits imprimés du label écologique autrichien, UW-Nr. 837





EGLO
my light | my style

EGLO Leuchten GmbH
Heiligkreuz 22
A-6136 Pill
Austria
Tel. +43 (0) 5242 6996
Fax +43 (0) 5242 6996-972
info@eglo.com
www.eglo.com

KATA25

my light | my style